



International Patent Public No.:
WO 2006/007772
US Patent No.: 7549446
India Patent No.: 232582
Russia Patent No.:2349819
South Korea Patent No.:10-0914137
Mexico Patent No.: 268581
Australia Patent No.: 2005263257
Philippine Patent No.: 1-2006-502553
Taiwan Patent No.:M287896

Multi-functional Flow Control Valve for Water Treatment Systems

63504, 63504B (Old Model No.: F63C1, F63G1)
63604, 63604B (Old Model No.: F63C3, F63G3)
73504, 73504B (Old Model No.: F68C1, F68G1)
73604, 73604B (Old Model No.: F68C3, F68G3)

User Manual





Please read this manual in details
before using this valve and keep it properly
in order to consult in the future

0WRX.466.501

MODEL:63504-F63C1/63604-F63C3/73504-F68C1/73604-F68C3

Before the valve put into use, please fill in the below content so as to help us to refer in the future.

The Program Type Setting (Operation by professional)

When all symbols light on, press and hold  and  buttons for 5 seconds to enter the menu of valve model selection. **Please set the program type in accordance with the product type.** (Time clock type by days or hours, or meter type. For example, F63C1 or F63G1 should be set to F63B1; F63C3 or F63G3 should be set to F63B3. You couldn't set to other type.)

Softener System Configuration

Tank Size: Dia. _____ mm; Height _____ mm;
Resin Volume _____ L; Brine Tank Capacity _____ L;
Hardness of Raw Water _____ mmol/L;
Pressure of Inlet Water _____ MPa;
Control Valve Model _____; Number _____;
The Specification of Drain Line Flow Control _____;
Injector No. _____.
Water Source: Ground-water Filtered Ground-water Tap Water Other _____.

Parameter Set

| Parameter | Unit | Factory Default | Actual Value |
|---|----------------|-----------------|--------------|
| Time of Day | H:m | Random | |
| Control Mode A-01 (02, 03, 04) | / | A-01 | |
| Unit Mode HU-01 (02, 03) | / | HU-01 | |
| Water Treatment Capacity (Meter type) | m ³ | 10:00 | |
| Service Days (Time clock type, by days) | D | 03 | |
| Service Hours (Time clock type, by hours) | H | 20 | |
| Regeneration Time | / | 02 : 00 | |
| Backwash Time | Min.sec | 10 : 00 | |
| Brine & Slow Rinse Time | Min.sec | 60 : 00 | |
| Brine Refill Time | Min.sec | 05 : 00 | |
| Fast Rinse Time | Min.sec | 10 : 00 | |
| Maximum Interval Regeneration Days | D. | 30 | |
| Output Mode b-01 (02) | / | b-01 | |

● If there is no special requirement when product purchase, we choose 6309 (old) injector and 8468007 (5#) drain line flow control for the standard configuration; if need new injector, we choose 6809 (new) injector and without drain line flow control for the standard configuration.

Catalogue

| | |
|--|----|
| Notice..... | 3 |
| 1. Product Overview..... | 4 |
| 1.1. Main Application & Applicability..... | 4 |
| 1.2. Product Characteristics..... | 4 |
| 1.3. Service Condition..... | 6 |
| 1.4. Product Structure and Technical Parameters..... | 7 |
| 1.5. Installation..... | 8 |
| 2. Basic Setting & Usage..... | 11 |
| 2.1. The Function of PC Board..... | 11 |
| 2.2. Basic Setting & Usage..... | 12 |
| 3. Applications..... | 16 |
| 3.1. Softener Flow Chart..... | 16 |
| 3.2. The Function and Connection of PC Board..... | 18 |
| A. Signal Output Connector..... | 19 |
| B. Interlock..... | 22 |
| C. Pressure Relief Output..... | 22 |
| D. Remote Handling Connector..... | 23 |
| E. Interlock System..... | 23 |
| F. Series System..... | 23 |
| 3.3. System Configuration and Flow Rate Curve..... | 24 |
| 3.4. Parameter Settlement..... | 27 |
| 3.5. Parameter Enquiry and Setting..... | 28 |
| 3.6. Trial Running..... | 33 |
| 3.7. Trouble-Shooting..... | 34 |
| 3.8. Assembly & Parts..... | 38 |
| 4. Warranty Card..... | 47 |

Notice

- To ensure normal operation of the valve, please consult with professional installation or repairing personnel before use it.
- If there are any of pipeline engineering and electric works, there must be finished by professional at the time of installation.
- Do not use the control valve with the water that is unsafe or unknown quality.
- Depending on the changing of working environment and water requirement, each parameter of softener should be adjusted accordingly.
- When the water treatment capacity is too low, please check the resin. If the reason is short of resin, please add; if the resin is turn to reddish brown or broken, please replace.
- Test water periodically to verify that system is performing satisfactorily.
- Sodium used in the water softening process should be considered as part of your overall dietary salt intake. Contact doctor if you are on a low sodium diet.
- Ensure that there is solid salt all the time in the brine tank in the course of using, when this valve is used for softening. The brine tank should be added crystalline coarse salt only, at least 99.5% pure, forbidding use the small salt.
- Do not put the valve near heat sources or surroundings with high humidity, corrosive, intense magnetic field or intense vibrations environment. And do not leave it outside.
- Forbidden to carry the injector body. Avoid to use injector body as support to carry the system.
- Forbidden to use the brine tube or other connectors as support to carry the system.
- Please use this product under the water temperature between 5 ~ 50°C, water pressure 0.15 ~ 0.6MPa. Failure to use this product under such conditions voids the warranty.
- If the water pressure exceeds 0.6MPa, a pressure reducing valve must be installed before the water inlet. While, if the water pressure is under 0.15MPa, a booster pump must be installed before the water inlet.
- PPR pipes, corrugated pipes, or UPVC pipes are recommended for pipe installation and aluminum-plastic pipes should be avoided.
- Do not let children touch or play, because careless operations may cause the procedure changed.
- When the attached cables of this product and transformer are damaged, they must be changed to the one that is from our factory.

1. Product Overview

1.1. Main Application & Applicability

Used for softening or demineralization water treatment systems

Be suitable for

- Residential softening system
- Ion exchange equipment
- Boiler softening water system
- RO pretreatment softening system, etc.

1.2. Product Characteristics

● Simple structure and reliable sealing

It adopts hermetic head faces with high degree pottery and corrosion resistance for opening and closing. It combines with Service, Backwash, Brine & Slow Rinse, Brine Refill and Fast Rinse.

● No water pass the valve in regeneration in single tank type.

● Manual function

Realize regeneration immediately by pressing “” at any time.



● Long outage indicator

If outage overrides 3 days, the time of day indicator “12:12” will flash to remind people to reset new time of day. The other set parameters do not need to reset. The process will continue to work after power on.

● LED dynamic screen display

The stripe on dynamic screen flash, it indicates the control valve is in service, otherwise, it is in regeneration cycle.



● Buttons lock

No operations to buttons on the controller within 1 minute, button lock indicator lights on which represent buttons are locked. Before operation, press and hold the  and  buttons for 5 seconds to unlock. This function can avoid incorrect operation.

● Interval backwash times (Suitable for F68)

It could set up interval backwash times for F68 up-flow regeneration valve which means several times of services but one time of backwash. The setting of interval backwash time depends on the local water turbidity. (The lower the turbidity is, the longer of the interval backwash time can be set)

● It can choose time clock type or meter type by program selection

When all symbols light on, press and hold  and  buttons for 5 seconds to enter the menu of valve model selection. Please set the program type in accordance with the product type. (Time clock type by days or hours or meter type) (Note: The meter type product has one flow meter and probe wire, but the time clock type doesn't have).

● Four kinds of meter type can be selected (Suitable for F63C3, F63G3,F68C3 ,F68G3)

| Model | Name | Instruction |
|-------|-----------------------------|--|
| A-01 | Meter Delayed | It will not regenerate although the available volume of treated water drops to zero (0).Regeneration will start until at the regeneration time. |
| A-02 | Meter Immediate | Regenerate immediately when the available volume of treated water drops to zero(0). |
| A-03 | Intelligent Meter Delayed | Meter Delayed Regeneration type, by setting resin volume, feed water hardness, regeneration factor, the controller will calculate the system capacity. |
| A-04 | Intelligent Meter Immediate | Meter Immediately Regeneration Type, by setting resin volume, feed water hardness, regeneration factor, the controller will calculate the system capacity. |

● There are two kinds of regeneration mode for time clock type

When the program is set to time clock type by days (Such as F63C1, F68C1, etc.), it can be changed to be by hours by dialing the red switch on main control board to “1” (Refer to the figure in P18). Pointing to “ON” mean the time clock type service by days.(Note: After dialing the switch, please restart the power)

● Interlock function

It has a function of interlock to realize only one valve in regeneration but the other valves are in service while several valves parallel in system. In multi-steps treatment systems such as RO pre-treatment, when several valves are in series, there is only one valve in regeneration or washing to ensure pass water all the times while different valves in regeneration or washing.(Application refer to Figure 3-9)

● Signal output

There is a signal output connector on main control board. It is for controlling external wiring (Refer to Figure 3-1 to Figure 3-8).

There are two kinds of output mode: b-01 Mode: Turn on start of regeneration and shut off end of regeneration; b-02 Mode: Signal available only intervals of regeneration cycles and in service.

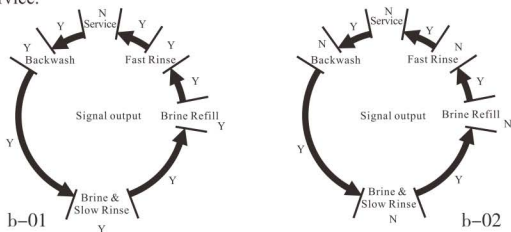

● **Remote handling input**

This connector can receive external signal, used together with PLC, and computer etc. to control the valve. (Application refers to Figure3-11)

● **Pressure relief output**

The valve will cut off feeding water to drain line when it switches in regeneration cycles (Same as signal output b-02). Thus in some water treatment system, e.g. Deep Well, one booster pump was installed on the inlet to increase the system water feeding pressure, this cut-off will cause pressure on inlet rising too fast to damage the valve. Pressure Relief Output can be used to avoid this problem. (Application refers to Figure3-10)

● **Maximum interval regeneration days**

Under the situation of service reaching the setting days and the volume not yet, it could enter into regeneration process forcibly when current time is the same as regeneration time.

● **All parameters can be modified**

According to the water quality and usage, the parameters in the process can be adjusted.

1.3. Service Condition

Runxin Valve should be used under the below conditions:

| Items | | Requirement |
|---------------------|-------------------------|---|
| Working conditions | Water pressure | 0.15MPa ~ 0.6MPa |
| | Water temperature | 5°C ~ 50°C |
| Working environment | Environment temperature | 5°C ~ 50°C |
| | Relative humidity | ≤95% (25°C) |
| | Electrical facility | AC100 ~ 240V/50 ~ 60Hz |
| Inlet water quality | Water turbidity | Down-flow regeneration < 5FTU; Up-flow regeneration < 2FTU |
| | Water hardness | First Grade Na ⁺ < 6.5mmol/L; Second Grade Na ⁺ < 10mmol/L |
| | Free chlorine | < 0.1mg/L |
| | Iron ²⁺ | < 0.3mg/L |
| | CODMn | < 2mg/L (O ₂) |

In the above table, First Grade Na⁺ represents First Grade Na⁺ Exchanger. Second Grade Na⁺ represents Second Grade Na⁺ Exchanger.

● **When the water turbidity exceeds the conditions, a filter should be installed on the inlet of control valve.**

● **When the water hardness exceeds the conditions, the outlet water hardness will hardly reach the requirement of boiler feed water (0.03 mmol/L). It is suggested to adopt second grade softener.**

1.4. Product Structure and Technical Parameters

Product dimension (The appearance is just for reference. It is subjected to the real product.)

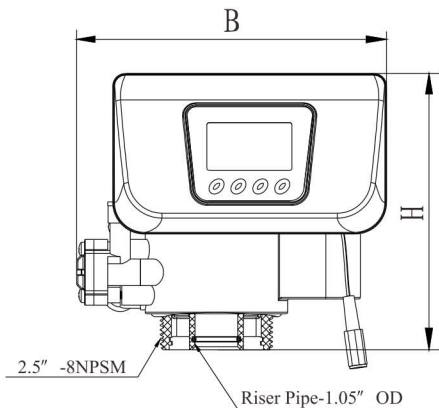
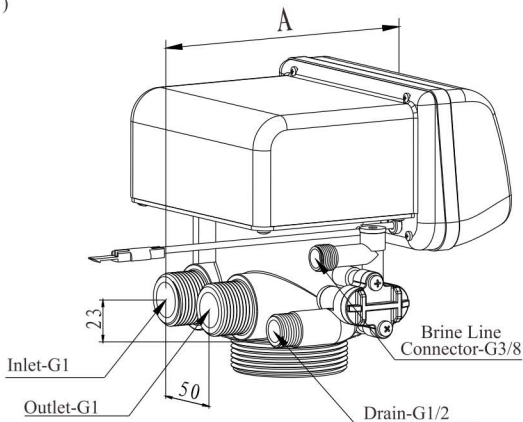

| Model | A (mm) max | B (mm) max | H (mm) max | Flow Rate m ³ /h @0.3MPa | Regeneration Mode |
|-------------|---------------|---------------|---------------|--|----------------------|
| F63C3/F63C1 | 282 | 198 | 177 | 4.0 | Down-flow |
| F63G3/F63G1 | 269 | 242 | 196 | 4.0 | Down-flow |
| F68C3/F68C1 | 282 | 198 | 176.5 | 4.0 | Up-flow |
| F68G3/F68G1 | 269 | 242 | 196 | 4.0 | Up-flow |

Note:

1. OD—Outer Diameter, 1.05OD=26.7mm

2. Transformer Output: DC12V/1.5A

1.5. Installation

A. Installation notice

Before installation, read all those instructions completely. Then obtain all materials and tools needed for installation.

The installation of product, pipes and circuits should be accomplished by professional to ensure the product can operate normally.

Perform installation according to the relevant pipeline regulations and the specifications of Water Inlet, Water Outlet, Drain Outlet, Brine Line Connector.

B. Device location

- ①The filter or softener should be located close to drain.
- ②Ensure the unit is installed in enough space for operating and maintenance.
- ③Brine tank needs to be close to softener.
- ④The unit should be kept away the heater, and not be exposed outdoor. Sunshine or rain will cause the system damage.
- ⑤Avoid installing the system in circumstance of acid/alkaline, magnetic or strong vibration, because above factors will cause the system disorder.
- ⑥Do not install the filter or softener, drain pipeline or overflow pipe in circumstance where temperature may drop below 5°C, or above 50°C.
- ⑦Install the system in the place where with the minimum loss in case of water leakage.

C. Pipeline installation

①Install control valve

- a. As the Figure 1-1 shows, select the riser pipe with 26.7mm OD, glue the riser pipe to the bottom strainer and put it into the mineral tank, cut off the exceeding pipe out of tank top opening and make external rounding.
- b. Fill the mineral to the tank, and the height is accordance with the design code.
- c. Install the top strainer to the valve.
- d. Through the top strainer, insert the riser pipe into control valve and screw tight control valve.

Note:

- The length of riser pipe should be neither 2mm higher nor 5mm lower than tank top opening, and its top end should be rounded to avoid damaging of O-ring inside the valve.
- Avoid filling floccules substance together with resin to the resin tank.
- Avoid O-ring inside control valve falling out while rotating it on the tank.

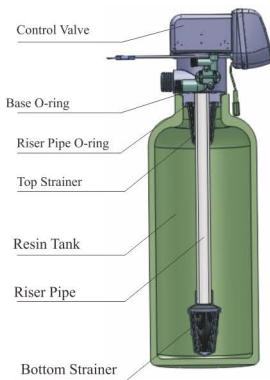

Figure1-1

② Install animated connector

As Figure1-2 shows, put the sealing ring into nut of animated connector, and screw in water inlet.

③ Install flow meter

As Figure1-2 shows, put the sealing ring into nut of flow meter, screw in water outlet; insert the probe wire into flow meter.

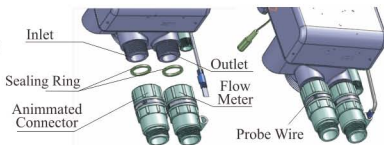

Figure1-2

④ Pipeline connection

a. As Figure1-3 shows, install a pressure gauge in water inlet.

b. Install valve A, valve B, valve C and valve D in the inlet, outlet and middle of the pipeline. The valve D is sampling valve. (Or adopt F70A/F70C bypass valve)

c. Install a check valve in water outlet.

d. Inlet pipeline should be in parallel with outlet pipeline. Support inlet and outlet pipeline with fixed holder.

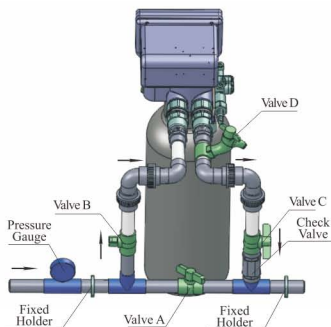

Figure1-3

Note:

● If the water outlet or water tank is installed higher than control valve or parallel interlock system with multi-outlets, a liquid level controller must be installed in brine tank or a check valve must be installed in the outlet. Or else, the water in water outlet or water tank will flow backwards into brine tank when backwash.

● If making a soldered copper installation, do all sweat soldering before connecting pipes to the valve. Torch heat will damage plastic parts.

● When turning threaded pipe fitting onto plastic fitting, do not use excessive force to make threads misaligned or broken valve.

● If the valve belongs to time clock type, there are no step ② and ③

⑤ Install drain pipeline

a. As the Figure 1-4 shows, slide the drain hose connector into drain outlet.

b. Insert drain line flow control into drain outlet

c. Screw drain hose connector into drain outlet, and lock it.

d. Locate the drain hose well as the Figure1-4 shows.

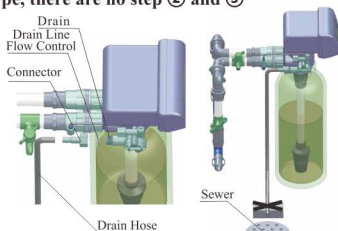

Figure 1-4

Note:

● Control valve should be higher than drain outlet, and be better not far from the drain hose.

● Be sure not connect drain with sewer directly, and leave a certain space between them, avoid wastewater being absorbing to the water treatment equipment, such as showed in the Figure1-4.

⑥ Connect brine tube

a. As Figure1-5 shows, slide 3/8" brine tube hose connector over end of brine tube.

b. Insert tube bushing into the end of brine tube.

c. Insert the red brine line flow control into valve brine line connector (Note: cone side of control should face into valve)

d. Tighten nut onto brine line connector.

e. Connect the other end of brine tube with the brine tank. (The liquid level controller and air-blocker should be installed in the brine tank.)

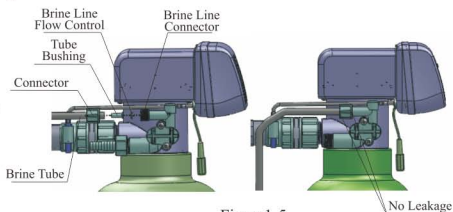
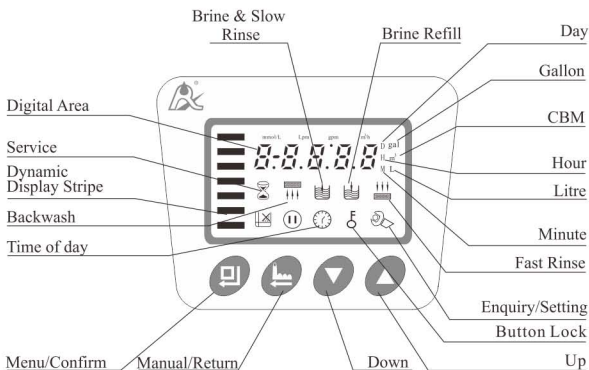

Figure1-5

Note: The brine tube and drain pipeline should not be bended or plugged.

2. Basic Setting & Usage

2.1. The Function of PC Board



A. ⌚ Time of day indicator

- ⌚ Lights on, display the time of day.
- "12:12" flashes, remind you to reset the time of day if electrical service interrupted 3 days more (If electrical service interrupted within 3 days, it doesn't need to reset the time.)



B. 🔒 Button lock indicator





- 🔒 Lights on, indicate the buttons are locked. At this moment, press any single button will not work (No operation in one minute, 🔒 will light on and lock the buttons.)
- Solution: Press and hold both ▲ and ▼ for 5 seconds until the 🔒 lights off.

C. 🔄 Program mode indicator

- 🔄 Lights on, enter program display mode. Use ▲ or ▼ to view all values.
- 🔄 Flashes, enter program set mode. Press ▲ or ▼ to adjust values.



D.  Menu/Confirm button



● In menu mode, press  and  lights on, then enter program display mode to view all values.

● In program display mode, press ,  flashes, enter program set mode, press  or  and to adjust values.

● Press  after all program are set, and then the voice “Di” means all setting are successful and return program display mode.



E.  Manual/Return button



● Press  in any status, it can proceed to next step.(Example: After unlock the buttons, press  in service status, it will start regeneration cycles instantly if the outlet water is unqualified; Press  while it is in backwash status, it will end backwash and go to brine & slow rinse at once.)

● Press  in program display mode, and it will return in service; Press  in program set mode, and it will return program display mode.

● Press  while adjusting the value, then it will return program display mode directly without saving value.

F. Up  and Down 

● In program display mode, press  or  to view all values.

● In program set mode, press  or  to adjust values.







● Press and hold both  and  for 5 seconds to unlock the buttons.

2.2. Basic Setting & Usage

A. Parameter specification

| Function | Indicator | Factory Default | Parameter Set Range | Instruction |
|--------------|--|-----------------|---------------------|---|
| Time of Day |  | Random | 00:00 ~ 23:59 | Set the time of day when use; “:” flashes. |
| Control Mode | A-01 | A-01 | A-01 | Meter Delayed: Regenerate will not start although the available volume of treated water drops to zero (0) . Regeneration will start until at the regeneration time. |
| | | | A-02 | Meter Immediate: Regenerate immediately when the available volume of treated water drops to zero(0). |
| | | | A-03 | Intelligent Meter Delayed: By setting resin volume, feed water hardness, regeneration factor, the controller will calculate the system capacity. Regeneration mode same as A-01. |
| | | | A-04 | Intelligent Meter Immediate: By setting resin volume, feed water hardness, regeneration factor, the controller will calculate the system capacity. Regeneration mode same as A-02. |

MODEL:63504-F63C1/63604-F63C3/73504-F68C1/73604-F68C3

| | | | | |
|------------------------------------|--|------------------|------------------------|--|
| Unit Mode | HU-01 | HU-01 | 01. 02. 03 | 01-m ³ ; 02-gal; 03-L |
| Service Days |  | 1-03D | 0 ~ 99 Days | Only for Time Clock Type, regeneration by days. |
| Service Hours |  | 1-20H | 0 ~ 99 Hours | Only for Time Clock Type, regeneration by hours. |
| Regeneration Time | 02:00 | 02:00 | 00:00 ~ 23:59 | Regeneration time; ":" lights on. |
| Interval Backwash Times | F-00 | 00 | 0 ~ 20 | Interval backwash times. For example, F-01:indicate service 2 times, backwash 1 time.(Only for F68A3, F68C3) |
| Resin Volume | 50L | 50L | 5 – 500L | Resin volume in resin tank (L) |
| Feed Water Hardness | Yd1.2 | 1.2 | 0.1 – 9.9 | Feed water hardness (mmol/L) |
| Exchange Factor | AL.65 | 0.65 | 0.30 – 0.99 | Relate to the raw water hardness. When hardness is higher, the factor is smaller. |
| Water Treatment Capacity |  | 10m ³ | 0~99.99 m ³ | Water treatment capacity in one circle (m ³) |
| Backwash Time |  | 10min. | 0 ~ 99 : 59 | Backwash time(Minute) |
| Brine & Slow Rinse Time |  | 60min. | 0 ~ 99 : 59 | Brine & Slow rinse time(Minute) |
| Brine Refill Time |  | 5min. | 0 ~ 99 : 59 | Brine refill time(Minute) |
| Fast Rinse Time |  | 10min. | 0 ~ 99 : 59 | Fast rinse time(Minute) |
| Maximum Interval Regeneration Days | H-30 | 30 | 0 ~ 40 | Regenerate at the regeneration time even though the available volume of treated water does not drop to zero (0). |
| Output Control Mode | b-01 | 01 | 01 or 02 | b-01: Signal turn on when start of regeneration and shut off at the end of regeneration. (Connection refers to the Figures on P5) b-02: Signal available only in intervals of each status. (Connection refers to the Figures on P5) |

B. Process Display



Figure A



Figure B



Figure C



Figure D



Figure E



Figure F



Figure G

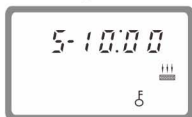

Figure H



Figure I

Illustration:

- In Service status, the figure shows A/B/C/D; In Backwash status, it shows figure E/I; In Brine & Slow Rinse status, it shows F/I; In Brine Refill status, it shows figure G/I; In Fast Rinse status, it shows figure H/I. In each status, every figure shows 15 seconds.
- Above displays are taking the meter type for example. For the time clock type, it shows the rest days or hours, such as 1-03D or 1-10H.
- The display screen will only show “-00-” when the electrical motor is running.
- The time of day figure “🕒” flashes continuously, such as “12:12” flashes, indicates long outage of power. It reminds to reset the time of day.
- The display will show the error code, such as “E1-” when the system is in error.
- Working process: Service→Backwash→Brine & Slow Rinse→Brine Refill→Fast Rinse→Service.













C. Usage

After being accomplished installation, parameter setting and trail running by professional, the valve could be put into use. In order to ensure the quality of outlet water can reach the requirement, the user should complete the below works:













① Ensure that there is solid salt all the time in the brine tank in the course of using when this valve is used for softening. The brine tank should be added crystalline coarse salt only, at least 99.5% pure, forbidding use the small salt and iodized salt.

② Test the hardness of outlet water and raw water at regular time. When the outlet water hardness is unqualified, please press the  and the valve will temporarily regenerate again (It will not affect the original set operation cycle)

③ When the feed water hardness change a lot, you can adjust the water treatment capacity as follow:

Press and hold both  and  for 5 seconds to unlock the buttons. Press , and the  lights on, then press , the digital area shows the control mode. If it shows A-01 or A-02, press  three times, and the digital area will show the given water treatment capacity (If the control mode shows A-03 or A-04, then press  four times, the digital area will show the feed water hardness); Press  again,  and digital flash. Press  or  continuously, adjust the capacity value (Or water hardness). Press  and hear a sound “Di” , then finish the adjustment. Press  exit and turn back the service status.

For the estimation of water treatment capacity, you can refer to the professional application specification. When selecting A-03 or A-04 intelligent control mode, the controller will automatically calculate the water treatment capacity by setting feed water hardness, resin volume, and regeneration factor.

④ For A-01 or A-03 control mode (Delayed regeneration type), please pay attention to whether the time is current or not. If the time is not right, you can adjust as below: After unlocking the buttons, press , the  and  light on. Then press , the  and hour value flash. Press  or  continuously, adjust the hour value; Press  again,  and minute value flash. Press  or  continuously, adjust the minute value; Press  and hear a sound “Di”, then finish the adjustment. Press  exit and turn back the service status.

The regeneration parameters have been set when control valve left factory. Generally, it does not need to reset. If you want to enquiry and modify the setting, you can refer to the professional application specifications.

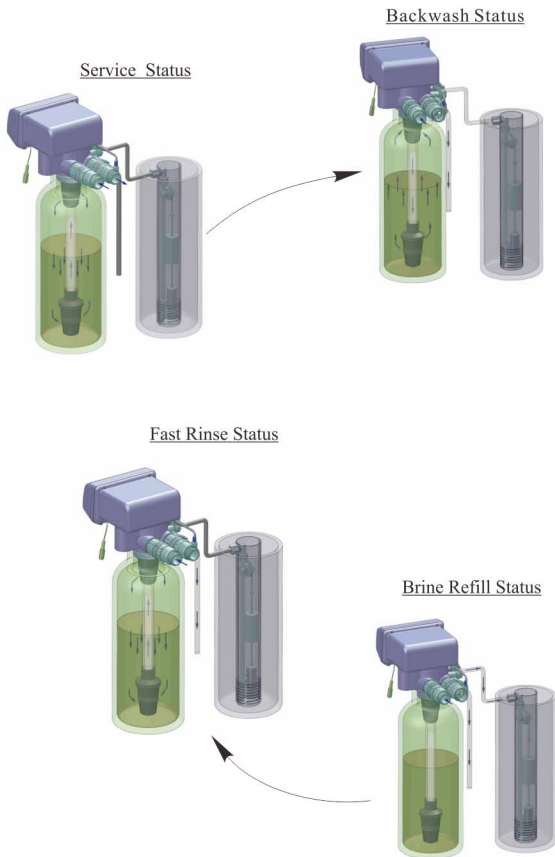

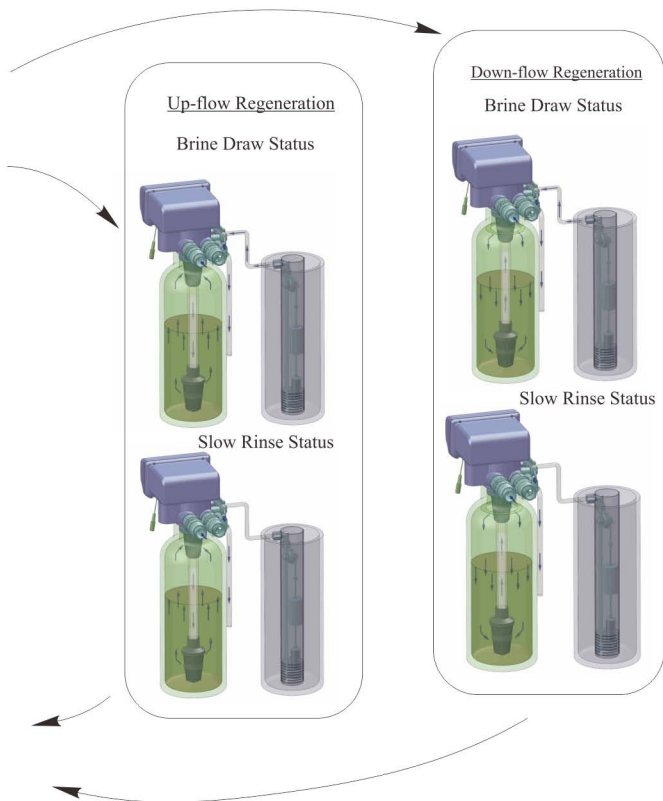

3.2. The Function and Connection of PC Board

Open the front cover of control valve, you will see the main control board and connectors as below:

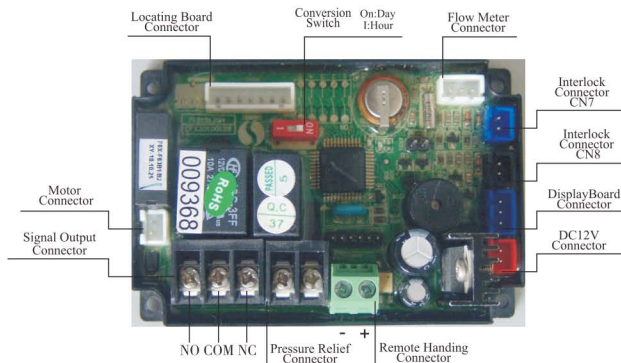

The main functions on main control board:

| Function | Application | Explanation |
|------------------------------|---|--|
| Signal output connector b-01 | Outlet solenoid valve | Used in strict requirements regarding no hard water flowing from outlet or control the liquid level controller in water tank. |
| | Inlet pump | Increase pressure for regeneration or washing. Use the liquid level controller to control inlet pump to ensure there is water in tank. |
| Signal output connector b-02 | Inlet solenoid valve or inlet pump | When inlet pressure is high, it needs to close water inlet to protect motor when valve is rotating. |
| Pressure relief connector | Control the inlet bypass to release pressure | Used for pump water supply. When valve is rotating, pressure relief connector opened to prevent pressure increasing rapidly. |
| Interlock connector | To ensure only one control valve regeneration or washing in system. | Use in RO Pre-treatment, water supply together but regeneration in turn. Second grade ion exchange equipment, etc. |
| Remote Handling connector | Receipt signal to make the control valve rotate to next status. | It is used for on-line inspection system, connected with PC to realize automatically or remote controlling valve. |

A. Signal Output Connector

1) Control Outlet Solenoid Valve (Set b-01)

① Solenoid Valve on Outlet Controls Water Level in Brine Tank.

Instruction: If system requires no hard water flowing from outlet in regeneration cycle (Mainly for no hard water flow out when valve is switching or valve in backwash or brine drawing status), a solenoid valve could be installed on outlet, the wiring refers to Figure 3-1.

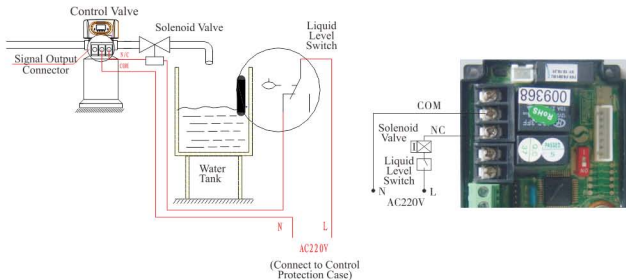

Figure3-1 Wiring of Solenoid Valve on Outlet

Function:

When valve is in service status, if soft water tank is short of water, solenoid valve will open to supply soft water, but if water tank has enough water, solenoid valve will close, so no soft water will be supplied into soft water tank.

When the valve is in backwash or other regeneration status, there is no signal output. So, solenoid valve will close, and no raw water flows into soft water tank.

② Control Inlet Solenoid Valve (Set b-02)

Instruction: When inlet pressure exceeds 0.6MPa, install a solenoid valve on inlet. Control mode is b-02. Pressure is relieved when valve switching, the wiring refers to Figure 3-2. As Figure 3-3 shows, it also can use the pressure relief connector to work.

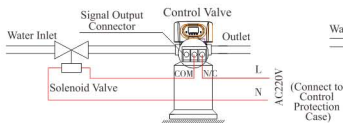

Figure 3-2 Wiring of Solenoid Valve on Inlet

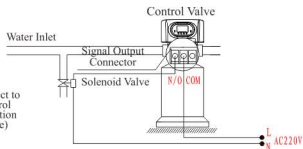

Figure3-3 Wiring of Solenoid Valve on Pressure Relief Port

Function:

When inlet pressure is high, install a solenoid valve on inlet to ensure valve switching properly. When valve is exactly in status of Service, Backwash, Brine & Slow Rinse, Brine Refill and Fast Rinse, solenoid valve is open. When valve is switching, solenoid valve is closed, no water flows into valve to ensure valve switching properly. It could prevent the problem of mixing water and water hammer.

Use interlock cable to realize valves in parallel and series in same system which is suited for RO pretreatment system or second grade Na⁺ system. The Wiring refers to Figure 3-4.

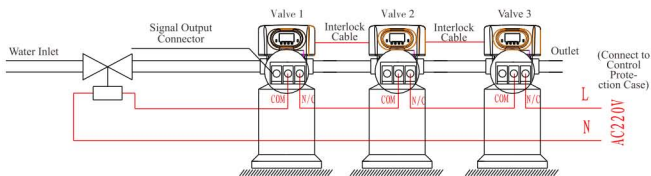

Figure 3-4 Wiring of Solenoid Valve in Inlet

2) Liquid Level Controller Controls Inlet Pump(Two-phase motor)(Set b-01)

Instruction: For the system using well or middle-tank supplying water, switch of liquid level controller and valve together control pump opening or closing. The wiring refers to Figure 3-5.

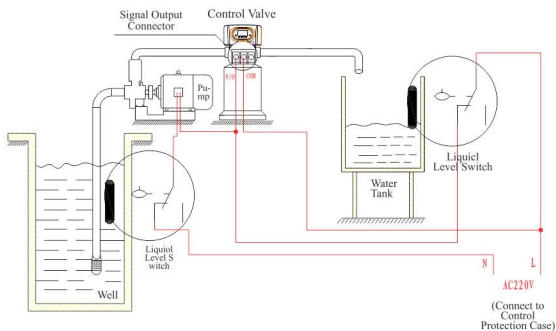

Figure 3-5 Wiring of Liquid Level Controller Controls Inlet Pump

Function:

When valve is in service status, if water tank is short of water, pump starts working; if not, the switch of liquid level controller is closed, so pump doesn't work.

When valve is in backwash or other regeneration status, no matter what is water condition in water tank, open the pump to make sure there is water on inlet. As there is no water flows out of outlet in regeneration cycle, it ensures no water fill into brine tank. A liquid level controller at the top opening of well or in middle water tank in RO system can protect pump from working without water in case of out of raw water.

3) Liquid Level Controller in Water Tank Controls Inlet pump (Three-phase) (Set b-01)

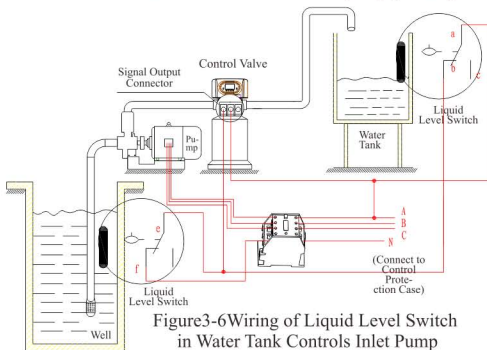

4) Control Inlet Booster Pump (Set b-01 or b-02)

Instruction: If inlet water pressure is less than 0.15MPa, which makes rinse drawing difficult, a booster pump is suggested to be installed on inlet. Control mode set to b-01. When system in regeneration cycle, booster pump is open, the wiring refers to Figure 3-7. If the booster pump current is bigger than 5A, the system needs to install a contactor, the wiring refers to Figure 3-8.

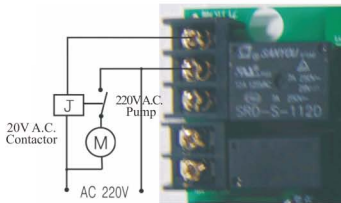
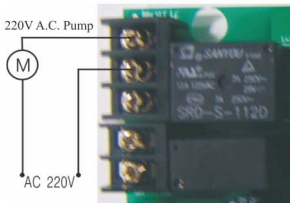

Figure 3-7 Wiring of Booster Pump on Inlet

Figure 3-8 Wiring of Booster Pump on Inlet

B. Interlock

Instruction:

In the parallel water treatment system, it ensures only one valve in regeneration or washing status and (n-1) valves in service, that is, realizing the function of supplying water simultaneously and regenerating individually, the wiring refers to Figure3-9.

In the series water treatment system(Second grade Na^+ Exchanger or RO pre-treatment system), it ensures only one valve in regeneration or washing status and there is/are water (s) in service.

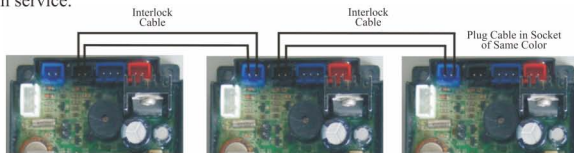

Figure 3-9 Network System Wiring with Interlock Cable

Note: Use interlock cable to connect the black socket of one valve with the blue socket of another valve in series.

One system with several valves, if interlock cable is disconnected, the system is divided into two individual system.

C. Pressure Relief Output

In adopt inlet booster pump or well water supply systems, valve switching will increase the system water feeding pressure, the motor can't rotate. Installing the solenoid valve in the inlet pipeline, connecting with the drain. When the valve switching, the pressure relief solenoid valve opens, the water flows to the drain. Avoiding the system closed, which will cause the inlet pressure rising too fast to damage the valve. The wiring refers to Figure 3-10.

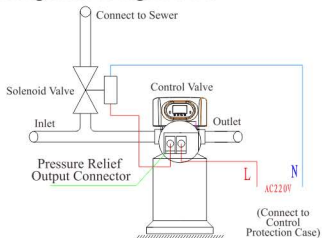

Figure 3-10 Wiring of Pressure Relief Output

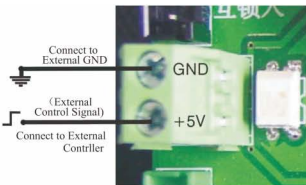

Figure 3-11 Wiring of Remote Input

D. Remote Handling Connector

When the valve is used to make pure water or other system that can be monitored online or connected to a PC, etc., when the conductivity or other parameters reach the set value or the PC sends a signal and needs system regeneration, it can provide a signal to remote handling connector of main control board by the signal line, which can make the valve regenerate immediately. The connector receiving the signal is equivalent to pressing the manual button. The wiring refers to Figure 3-11:

E. Interlock System

2 or more than 2 valves are interlocked connecting in one system and all valves are in service but regenerate individually. The wiring refers to Figure3-12:

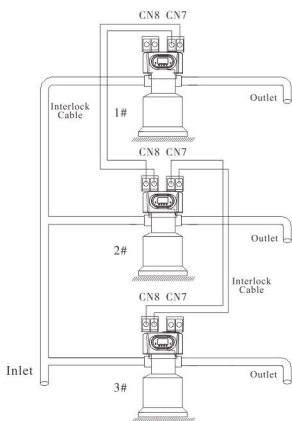

Figure 3-12 Interlock system

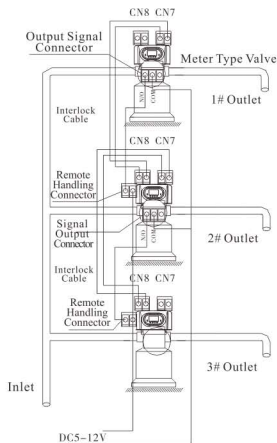

Figure 3-13 Series system

F. Series System

This is a 2 or more than 2 valves system, all in service, with one flow meter for the entire system. For the time type valve, the regeneration time should be set and adjusted to the Max; for the meter type valve, connect its signal output connector with the remote handling connector of the time clock type valve. That can realize the function of supplying water simultaneously and regenerating orderly. The wiring refers to Figure 3-13.

3.3. System Configuration and Flow Rate Curve

A. Product Configuration

Product configuration with tank, resin volume, brine tank and injector

| Tank Size (mm) | Resin Volume (L) | Flow Rate (t/h) | Brine Tank Size (mm) | The Minimum Salt Consumption for Regeneration (Kg) | Injector Model (Old/New) |
|----------------|------------------|-----------------|----------------------|--|--------------------------|
| φ 180×1130 | 16 | 0.5 | φ 250×520 | 2.40 | 6302/6801 |
| φ 205×1300 | 25 | 0.7 | φ 390×810 | 4.00 | 6303/6802 |
| φ 255×1390 | 40 | 1.2 | φ 390×810 | 6.00 | 6305/6804 |
| φ 300×1650 | 60 | 1.8 | φ 450×940 | 9.00 | 6306/6806 |
| φ 355×1650 | 100 | 2.5 | φ 500×1060 | 15.00 | 6308/6808 |
| φ 400×1650 | 120 | 3.5 | φ 550×1160 | 18.00 | 6309/6809 |
| φ 450×1650 | 150 | 4.5 | φ 500×1160 | 22.50 | 6310/6810 |

Note: The flow rate calculation is based on linear velocity 25m/h; the minimum salt consumption for regeneration calculation is based on salt consumption 150g/L (Resin).

B. Flow Rate Characteristic

1). Pressure-flow rate curve

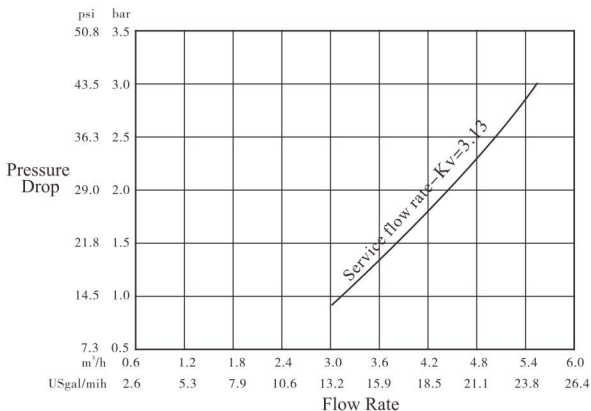

MODEL:63504-F63C1/63604-F63C3/73504-F68C1/73604-F68C3

2). Injector Parameter Table

Old Injector: (6300 series)

| Inlet Pressure | Draw Rate (L/M) | | | | | | | | | |
|----------------|-----------------|--------------|----------------|--------------|---------------|---------------|----------------|-------------|---------------|----------------|
| MPa | 6301 Coffee | 6302 Pink | 6303 Yellow | 6304 Blue | 6305 White | 6306 Black | 6307 Purple | 6308 Red | 6309 Green | 6310 Orange |
| 0.15 | 0.81 | 1.12 | 1.58 | 2.21 | 2.45 | 3.30 | 3.44 | 4.08 | 5.19 | 5.69 |
| 0.20 | 0.95 | 1.41 | 1.87 | 2.53 | 2.89 | 3.88 | 4.21 | 4.83 | 5.36 | 6.80 |
| 0.25 | 0.99 | 1.61 | 2.08 | 2.79 | 3.30 | 4.30 | 4.66 | 5.39 | 6.86 | 7.65 |
| 0.30 | 1.30 | 1.81 | 2.18 | 3.05 | 3.66 | 4.74 | 5.15 | 5.95 | 7.50 | 8.60 |
| 0.35 | 1.45 | 1.96 | 2.39 | 3.27 | 3.94 | 5.02 | 5.55 | 6.51 | 8.30 | 9.57 |
| 0.40 | 1.56 | 2.12 | 2.55 | 3.50 | 4.25 | 5.41 | 5.88 | 6.77 | 8.74 | 9.90 |

New Injector:(6800 series)

| Inlet Pressure | Draw Rate (L/M) | | | | | | | | | | | |
|----------------|-----------------|--------------|----------------|--------------|----------------|--------------|---------------|---------------|----------------|-------------|---------------|----------------|
| MPa | 6820 Gray | 6821 Cyan | 6801 Coffee | 6802 Pink | 6803 Yellow | 6804 Blue | 6805 White | 6806 Black | 6807 Purple | 6808 Red | 6809 Green | 6810 Orange |
| 0.15 | 0.61 | 0.88 | 1.3 | 1.45 | 2.00 | 2.68 | 2.72 | 3.72 | 4.52 | 4.85 | 5.75 | 6.00 |
| 0.20 | 0.70 | 1.03 | 1.52 | 1.73 | 2.37 | 3.16 | 3.27 | 4.27 | 5.03 | 5.70 | 6.40 | 6.26 |
| 0.25 | 0.79 | 1.14 | 1.77 | 1.90 | 2.7 | 3.46 | 3.78 | 4.80 | 5.65 | 6.22 | 7.19 | 7.13 |
| 0.30 | 0.87 | 1.27 | 1.93 | 2.26 | 3.00 | 3.80 | 4.30 | 5.23 | 6.20 | 6.80 | 7.97 | 8.53 |
| 0.35 | 0.95 | 1.35 | 2.08 | 2.20 | 3.23 | 4.05 | 4.50 | 5.57 | 6.67 | 7.27 | 8.50 | 8.80 |
| 0.40 | 1.00 | 1.43 | 2.23 | 2.27 | 3.46 | 4.38 | 4.88 | 5.95 | 6.95 | 7.63 | 8.80 | 9.30 |

3) Configuration for Standard Injector and Drain Line Flow Control

Old Injector:(6300 series)

| Tank Dia. mm | Injector Model | Injector Color | Draw Rate | Slow Rinse Rate | Brine Refill Rate | DLFC | Backwash/ Fast Rinse Rate |
|-----------------|-------------------|-------------------|-----------|--------------------|----------------------|------|---------------------------------|
| | | | L/m | L/m | L/m | | L/m |
| 150 | 6301 | Coffee | 1.30 | 0.91 | 3.0 | 1# | 4.7 |
| 175 | 6302 | Pink | 1.81 | 1.32 | 3.7 | 1# | 4.7 |
| 200 | 6303 | Yellow | 2.18 | 1.73 | 3.8 | 2# | 8.0 |
| 225 | 6304 | Blue | 3.05 | 2.14 | 3.3 | 2# | 8.0 |
| 250 | 6305 | White | 3.66 | 2.81 | 4.3 | 3# | 14.4 |
| 300 | 6306 | Black | 4.74 | 3.32 | 4.2 | 3# | 14.4 |

MODEL:63504-F63C1/63604-F63C3/73504-F68C1/73604-F68C3

| | | | | | | | |
|-----|------|--------|------|------|-----|----|------|
| 325 | 6307 | Purple | 5.15 | 3.55 | 4.1 | 4# | 22.8 |
| 350 | 6308 | Red | 5.95 | 4.00 | 4.0 | 4# | 22.8 |
| 400 | 6309 | Green | 7.50 | 5.13 | 4.0 | 5# | 26.4 |
| 450 | 6310 | Orange | 8.60 | 5.98 | 3.9 | 5# | 26.4 |

New Injector:(6800 series)

| Tank Diameter Mm | Injector # | Injector Color | Draw Rate (Total) | Slow Rinse | Part Number of BLFC | Brine Refill | Part Number of DLFC | Backwash and Fast Rinse |
|------------------|------------|----------------|-------------------|------------|---------------------|--------------|---------------------|-------------------------|
| | | | L/m | L/m | | L/m | | L/m |
| 150 | 6821 | Cyan | 1.27 | 0.75 | 8468057 | 0.98 | 8468064 | 3.33 |
| 175 | 6801 | Coffee | 1.93 | 1.18 | 8468057 | 0.98 | 8468043 | 4.31 |
| 200 | 6802 | Pink | 2.26 | 1.24 | 8468056 | 1.21 | 8468042 | 7.15 |
| 225 | 6803 | Yellow | 3.00 | 1.70 | 8468056 | 1.21 | 8468060 | 7.64 |
| 250 | 6804 | Blue | 3.80 | 2.40 | 8468052 | 1.66 | 8468061 | 10.82 |
| 300 | 6806 | Black | 5.23 | 3.30 | 8468053 | 2.73 | 8468077 | 18.10 |
| 325 | 6807 | Purple | 6.20 | 3.73 | 8468053 | 2.73 | 8468044 | 18.50 |
| 350 | 6808 | Red | 6.80 | 4.10 | 8468054 | 4.92 | 8468062 | 24.97 |
| 400 | 6809 | Green | 7.97 | 4.87 | 8468055 | 5.86 | 8468063 | 30.64 |
| 450 | 6810 | Orange | 8.53 | 5.60 | 8468055 | 5.86 | No DLFC | 32.00 |

4). BLFC Parameter Table (Only for New Injector)

| Part Number | | 8468076 | 8468075 | 8468057 | 8468056 | 8468052 | 8468053 | 8468054 | 8468055 |
|-------------|---------|---------|---------|---------|---------|---------|---------|---------|---------|
| Color | | Red | Purple | Black | White | Coffee | Pink | Yellow | Blue |
| Flow Rate | L/m | 0.38 | 0.68 | 0.98 | 1.21 | 1.66 | 2.73 | 4.92 | 5.86 |
| | gal/min | 0.10 | 0.18 | 0.26 | 0.32 | 0.44 | 0.72 | 1.30 | 1.55 |

5). DLFC Parameter Table (Only for New Injector)

| Part Number | | 8468064 | 8468043 | 8468042 | 8468060 | 8468061 | 8468045 | 8468077 | 8468044 | 8468062 | 8468063 | No DLFC |
|-------------|---------|---------|---------|---------|---------|---------|---------|---------|---------|---------|---------|---------|
| Color | | Green | Pink | Coffee | White | Black | Blue | Orange | Yellow | Purple | Red | / |
| Flow Rate | L/m | 3.33 | 4.31 | 7.15 | 7.64 | 10.82 | 15.96 | 18.10 | 18.50 | 24.97 | 30.64 | 32.00 |
| | gal/min | 0.88 | 1.14 | 1.89 | 2.02 | 2.86 | 4.22 | 4.78 | 4.89 | 6.60 | 8.10 | 8.45 |

Note: Above data for the product configuration and relevant characteristics are only for reference. When put in practice, it is subject to the different requirements of raw water hardness and application.

3.4. Parameter settlement

①Service Time T1

Water treatment capacity:

$$Q = V_R \times K \div Y_D \quad (\text{m}^3)$$

Hardness of inlet water (mmol/L)

Exchange factor (mmol/L) 400 ~ 1000.

Down-flow regeneration, take 400 ~ 750. Up-flow regeneration, take 450 ~ 1000. If the inlet water hardness is higher, the factor is smaller.

Resin volume (m^3)

By hours: $T1 = Q \div Q_h \quad (\text{Hour})$

Average water consumption per hour (m^3/h)

Water treatment capacity (m^3)

By days: $T1 = Q \div Q_d \quad (\text{Day})$

Average water consumption per day (m^3/d)

Water treatment capacity (m^3)

②Backwash Time T2

Generally, it is suggested to be set 10~15 minutes. The higher the turbidity is, the longer backwash time can be set. However, if the turbidity is more than 5FTU, it should be better to install a filter in front of the exchanger.

③Brine & Slow Rinse Time T3

$$T3 = (40 \sim 50) \times H_R \quad (\text{min.})$$

Generally, $T3 = 45H_R \quad (\text{min.})$

In this formula, H_R —The height of resin in exchange tank (m.)

④Brine Refill Time T4

Down-flow regeneration: $T4 = 0.45 \times V_R \div \text{Brine refill speed} \quad (\text{min.})$

Up-flow regeneration: $T4 = 0.34 \times V_R \div \text{Brine refill speed} \quad (\text{min.})$

In this formula, V_R —Resin volume (m^3)

The Brine refill speed is related to inlet water pressure. It is suggested to be 1~2 minutes longer than the calculated brine refilling time to make sure there is enough water in tank. (The brine tank should be equipped with liquid level controller)

⑤Fast Rinse Time T5

$$T5 = 12 \times H_R \quad (\text{min.})$$

Generally, the water for fast rinse is 3 ~ 6 times of resin volume. It is suggested to be set 10 ~ 16 minutes, But it should meet the requirements of qualified outlet water.

⑥Exchange Factor

$$\text{Exchange factor} = E / (K \times 1000)$$

In this formula, E —Resin working exchange capability (mol/m^3), it is related to the quality of resin. Down-flow regeneration, take 800 ~ 900. Up-flow regeneration, take 900 ~ 1200.

K —Security factor, always take 1.2 ~ 2. It is related to the hardness of inlet water: the higher the hardness is, the bigger the K is.

⑦Set Up Interval Backwash Times (Only for F68)

When the turbidity of raw water is higher, the interval backwash time could be set F-00. That is to say, backwash in each regeneration; when the turbidity is lower, the interval backwash time could be set F-01(or other number value), it is to say that backwash in every two regeneration. Thus, Service→Brine& slow rinse→Brine refill→ Fast rinse→ Service→ Backwash →Brine& slow rinse →Brine refill →Fast rinse.

⑧Regeneration Time

The whole cycle for regeneration is about two hours. According to the actual situation, please try to set up the regeneration time when you don't need to use water.

The calculation of parameters for each step is only for reference, the actual proper time will be determined after adjusting by water exchanger supplier. This calculation procedure of softener is only for industrial application; it is not suitable for small softener in residential application.

3.5. Parameter Enquiry and Setting

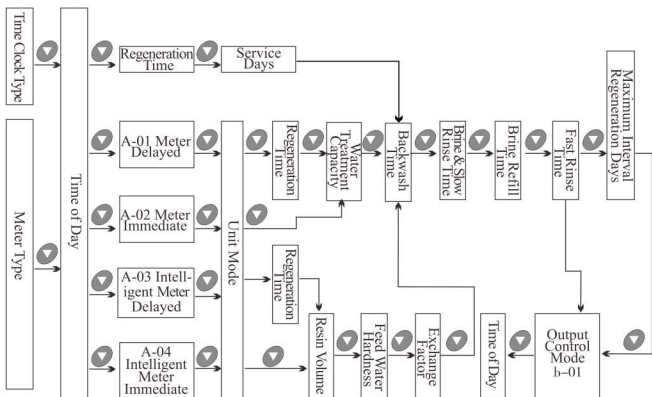

3.5.1. Parameter Enquiry

When ♂ lights on, press and hold both ▲ and ▼ for 5 seconds to unlock the button; then press □ and ⊗ lights on, enter to program display mode; press ▲ or ▼ to view each value according to below process. (Press ⊗ exit and turn back to service status)

















































































Note: For the F68 valve, after enquiry “Unit Mode” or “Regeneration Time”, it will show “F-00”, which indicates the interval backwash times.

















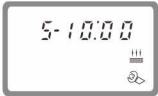

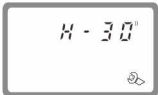

3.5.2.Parameter Setting

In program display mode, press  and enter into program set mode. Press  or  to adjust the value.

3.5.3.The steps of parameter setting (Take F68C3, A-01 as sample)

| Items | Process steps | Symbol |
|-------------------|--|---|
| Time of Day | <p>When time of day “12: 12” continuously flash, it reminds to reset;</p> <p>1. Press  to enter into program display mode; both  and  symbol light on, “: ” flash; Press , to set “time of day” mode, both  and hour value flash, through  or  to adjust the hour value;</p> <p>2. Press  again, both  and minute value flash, through  or  to adjust the minute value;</p> <p>3. Press  and hear a sound “Di” , then finish adjustment, press  to turn back.</p> |  |
| Control Mode | <p>1. In program display mode, press  and enter into program set mode,  and 01 value flash;</p> <p>2. Press  or , set the value to be A-01/02/03/04 control mode;</p> <p>3. Press  and hear a sound “Di”, then finish adjustment, press  to turn back.</p> |  |
| Unit Mode | <p>1. In unit mode display status, press  and enter into program set mode,  and 01 value flash;</p> <p>2. Press  or , and choose the unit from the m³/L/gal;</p> <p>3. Press  and hear a sound “Di”, then finish adjustment, press  to turn back.</p> |  |
| Regeneration Time | <p>1. In regeneration time display status, press  and enter into program set mode. Shows “02:00” ,  and 02 flash; Press  or  to adjust the hour value;</p> <p>2. Press  again,  and 00 flash, press  or  to adjust the minute value;</p> <p>3. Press  and hear a sound “Di” , then finish adjustment, press  to turn back.</p> |  |

| | | |
|-----------------------------------|--|---|
| <p>Interval Back-wash Times</p> | <p>1. In Interval backwash time display status, it shows F-00. Press  and enter into program set mode.  And 00 value flash; 2. Press  or  to adjust the interval backwash times value; 3. Press  and hear a sound “Di”, then finish adjustment, press  to turn back.</p> |  |
| <p>Water Treatment Capacity</p> | <p>1. In water treatment capacity display status, it shows  and 10.00. Press  and enter into program set mode.  and 10.00 flash 2. Press  or  to adjust the water treatment capacity value (m³) ; 3. Press  and hear a sound “Di” , then finish adjustment, press  to turn back.</p> |  |
| <p>Back-wash Time</p> | <p>1. In backwash time display status, it shows  and 2-10:00. Press  and enter into program set mode.  and 10:00 flash; 2. Press  or  to set the backwash time (minute); 3. Press  and hear a sound “Di”, then finish adjustment, press  to turn back.</p> |  |
| <p>Brine& Slow Rinse Time</p> | <p>1. In brine& slow rinse time display status, it shows  and 3-60:00. Press  and enter into program set mode.  and 60:00 flash; 2. Press  or  to adjust the brine &slow rinse time (minute); 3. Press  and hear a sound “Di”, then finish adjustment, press  to turn back.</p> |  |
| <p>Brine Refill Time</p> | <p>1. In brine refill time display status, it shows  and 4-05:00, press  and enter into program set mode.  and 05:00 flash; 2. Press  or  to adjust the brine refill time (minute); 3. Press  and hear a sound “Di”, then finish adjustment, press  to turn back.</p> |  |

| | | |
|---|--|---|
| <p>Fast Rinse Time</p> | <p>1. In fast rinse time display status, it shows  and 5-10:00. Press  and enter into program set mode.  and 10:00 flash;</p> <p>2. Press  or  to adjust the fast rinse time (minute);</p> <p>3. Press  and hear a sound “Di”, then finish adjustment, press  to turn back.</p> |  |
| <p>Maximum Interval Regeneration Days</p> | <p>1. In maximum interval regeneration days display status, it shows H-30. Press  and enter into program set mode.  and 30 flash;</p> <p>2. Press  or  to adjust the interval regeneration days(day);</p> <p>3. Press  and hear a sound “Di”, then finish adjustment, press  to turn back.</p> |  |
| <p>Signal Output Mode</p> | <p>1. In signal output mode display status, it shows b-01. Press  and enter into program set mode.  and 01 flash;</p> <p>2. Press  or  to set the output mode;</p> <p>3. Press  and hear a sound “Di”, then finish adjustment, press  to turn back.</p> |  |

MODEL:63504-F63C1/63604-F63C3/73504-F68C1/73604-F68C3

For example, the fast rinse time of a softener is 12 minutes. After regenerating, the chloridion in the outlet water is always higher than normal, indicating that there is not enough time for fast rinse. If you want to set the time to 15 minutes, the modification steps as follows:



- ① Press and hold both ▲ and ▼ to unlock the button. (Ⓕ lights off);
- ② Press □, and Ⓕ lights on;
- ③ Press ▲ or ▼ continuously, until Ⓕ lights on. Then the digital area shows: 5-12M;
- ③ Press □, Ⓕ and 12 flash;
- ⑤ Press ▲ continuously until 12 changed to 15;
- ⑥ Press □, there is a sound “Di” and the figure stop flashing; the program back to program display mode.
- ⑦ If you want to adjust other parameters, you can repeat the steps from ② to ⑤; If you don't, press Ⓕ and exit from the program display mode, the display will show the current service status.



3.6. Trial Running



After installing the multi-functional flow control valve on the resin tank with the connected pipes, as well as setting up the relevant parameters, please conduct the trial running as follows:



A. Close inlet/outlet valve B and Valve C, open bypass valve A, clean the impurity in the pipe, and then close the bypass valve A. (as Figure 1-3 shows)



B. Add calculated water to the brine tank and adjust the air check valve. Then add solid salt to the brine tank and dissolve the salt as much as possible.

C. Switch on power. Press  and enter into the backwash status; when  lights on, slowly open the inlet valve B to 1/4 position, making the water flows into the resin tank; you can hear the sound of air-out from the drain pipeline. After all air is out of pipeline, then open inlet valve B completely and clean the impurity in the resin tank until the outlet water is clean. It will take 8~10 minutes to finish the whole process.

D. Press , and turn the status from backwash to brine & slow rinse; When  lights on and enter in the process of brine & slow rinse. The air check valve will close when control valve finished sucking brine, then slow rinse starts to work. It is about 60~65 minutes for whole process.

E. Press  to brine refill status. When  lights on and it indicates the brine tank is being refilled with water to the required level. It takes about 5~6 minutes, then add solid salt to the brine tank.

F. Press , and turn to fast rinse status. When  lights on and starts to fast rinse. After 10~15 minutes, take some outlet water for testing: if the water hardness reaches the requirement, and the content of chloridion in the outlet water is almost same as the inlet water, then the valve can go to the next step.

G. Press , make the control valve return to service status; When  lights on and starts running.

Note:

● When the control valve enters into the regeneration status, all program can be finished automatically according to the setting time; if you want one of steps terminated early, you can press .

● If water inflows too fast, the media in tank will be damaged. When water inflows slowly, there is a sound of air emptying from drain pipeline.

● After changing resin, please empty air in the resin according to above Step C.

● In the process of trial running, please check the water situation in all status, ensuring there are no resin leakage.

● The time for Backwash, Brine& Slow Rinse, Brine Refill and Fast Rinse status can be set and executed according to the calculation in the formula or suggestions from the control valve suppliers.

3.7. Trouble-Shooting

A. Control Valve Fault

| Problem | Cause | Correction |
|-------------------------------------|--|---|
| 1.Softener fails to regenerate. | A. Electrical service has been interrupted. B. Regeneration time set incorrect. C. Controller damaged. D. Motor fails to work. | A. Assure permanent electrical service(Check fuse, plug, switch and so on). B. Reset regeneration time. C. Replace controller. D. Replace motor. |
| 2.Regeneration time is not correct. | A. Time of day does not set correctly. B. Power failure more than 3 days. | A.Check program and reset time of day. B.Reset time of day |
| 3.Softener supply hard water. | A. Bypass valve is open or leaking. B. No salt in brine tank. C. Injector plugged. D. Insufficient water flows into brine tank. E. O-ring on riser pipe leaks. F. Internal valve leaks. G. Regeneration cycles are not correct or raw water quality deterioration. H. Shortage of resin. I. Bad quality of feed water or impeller blocked. | A. Close or repair bypass valve. B. Make sure there is solid salt in the brine tank. C. Change or clean injector. D. Check brine tank refill time. E. Make sure riser pipe is not cracked. Check o-ring and tube pilot. F. Check and repair valve body. G. Set correct regeneration time or water capacity. H. Add resin to mineral tank and check whether resin leaks. I. Reduce the inlet turbidity, clean or replace flow meter. |
| 4.Softener fails to draw brine. | A. Inlet pressure is too low. B. Brine line plugged. C. Brine line leaks. D. Injector plugged or damaged. E. Internal control leaks. F. Drain line plugged. G. Sizes of injector and DLFC are not matched with tank. | A. Increase inlet pressure. B. Clean brine line. C. Clean brine line. D. Clean or replace injector. E. Repair or replace valve body. F. Check drain line . G. Select correct injector and DLFC according to the instruction requirements. |
| 5.Unit used too much salt. | A. Improper salt setting. B. Excessive water in brine tank. | A. Check salt usage and salt setting. B. See problem no.6. |

| | | |
|--|--|--|
| <p>6.Excessive water in brine tank.</p> | <p>A. Overlong brine refill time. B. Excessive water left after brine. C. Foreign material in brine valve. D. Not install liquid level controller and power failure in brine status. E. Brine refill is uncontrolled</p> | <p>A. Reset correct brine refill time. B. Check the injector and make sure no stuff in the brine pipe. C. Clean liquid level controller. D. Stop water supplying, and restart or install liquid level controller in salt tank when power restored. E. Repair or replace liquid level controller.</p> |
| <p>7.Pressure lost or the pipe rusty.</p> | <p>A. Iron scale in the water supply pipe. B. Iron scale accumulated in the softener. C. Fouled resin bed. D. Too much iron in the raw water.</p> | <p>A. Clean the water supply pipe. B. Clean valve and add resin cleaning chemical, increase frequency of regeneration. C. Check backwash, brine draw and brine tank refill. Increase frequency of regeneration and backwash time. D. Iron removal equipment is required to install before softening.</p> |
| <p>8.Resin discharged through drain pipe</p> | <p>A. Air in water system. B. Strainer is broken C. Large drain flow rate when backwash.</p> | <p>A. Empty the air from the system. B. Replace new strainer. C. Check and adjust proper drain rate.</p> |
| <p>9.Control cycle continuously.</p> | <p>A. Locating signal wire breakdown. B. Controller is faulty. C. Foreign material stuck the driving gear. D. Time of regeneration steps were set to zero.</p> | <p>A. Check and connect locating signal wire. B. Replace controller. C. Take out foreign material. D. Check program setting and reset.</p> |
| <p>10.Drain flows continuously.</p> | <p>A. Internal valve leaks. B. Power off when in backwash or fast rinse.</p> | <p>A. Check and repair valve body or replace it. B. Adjust valve to service status or turn off bypass valve and restart when electricity supply.</p> |
| <p>11.Interrupted or irregular brine.</p> | <p>A. Water pressure is too low or not stable. B. Injector is plugged or damaged. C. Air in resin tank. D. Floccules in resin tank during up-flow regeneration.</p> | <p>A. Increase water pressure. B. Clean or replace injector. C. Check and find the reason. D. Clean the floccules in resin tank.</p> |

| | | |
|---|--|---|
| <p>12. Water flows out from drain or brine pipe after regeneration.</p> | <p>A. Foreign material in valve which makes valve can't be closed completely. B. Hard water mixed in valve body. C. Water pressure is too high which results in valve not getting the right status D. In the backwash status, the outlet line and brine line are connected.</p> | <p>A. Clean foreign material in valve body. B. Change valve core or sealing ring. C. Reduce water pressure or use pressure release function. D. Install a check valve, solenoid valve in front of the outlet or install a liquid level controller in the brine tank.</p> |
| <p>13. Salt water in outflow pipe</p> | <p>A. Foreign material in injector or injector fails to work. B. Brine valve cannot be shut-off. C. Fast rinse time is too short.</p> | <p>A. Clean and repair injector. B. Repair brine valve and clean it. C. Extend fast rinse time.</p> |
| <p>14. Water capacity decreases.</p> | <p>A. Regenerate not properly. B. Fouled resin bed. C. Salt setting is not proper. D. Softener setting is not proper. E. Raw water quality deteriorated. F. Impeller has already gotten stuck.</p> | <p>A. Regenerate according to the right way. B. Increase backwash flow rate and time, clean or change resin. C. Reset the appropriate amount of salt D. According to the test of outlet water, recount and reset. E. Regenerate by manual temporary, then reset regeneration cycle. F. Disassemble flow meter and clean it, or replace it with a new flow meter.</p> |

B. Controller Fault

| Problem | Cause | Correction |
|---|---|--|
| 1. All indicators display on display board. | A. Wiring of display board with control board fails to work. B. Control board damaged. C. Transformer damaged. D. Electrical service not stable. | A. Check and replace the wiring. B. Replace control board. C. Check and replace transformer. D. Check and adjust electrical service. |
| 2. No display on display board. | A. Wiring of display board with controller fails to work. B. Display board damaged. C. Control board damaged. D. Electricity is interrupted. | A. Check and replace wiring. B. Replace display board. C. Replace control board. D. Check electricity. |
| 3. E1 Flashes | A. Wiring of locating board with control board fails to work. B. Locating board damaged. C. Mechanical driven failure. D. Control board damaged. E. Wiring of motor with control board is fault. F. Motor damaged. | A. Replace wiring. B. Replace locating board. C. Check and repair mechanical part. D. Replace control board. E. Replace wiring. F. Replace motor. |
| 4. E2 Flashes | A. Hall component on locating board damaged. B. Wiring of locating board and control board fails to work. C. Control board damaged. | A. Replace locating board. B. Replace wiring. C. Replace control board. |
| 5. E3 or E4 Flashes | A. Control board damaged. | A. Replace control board. |

3.8. Assembly & Parts

Flow Meter Connector & Animated Connector

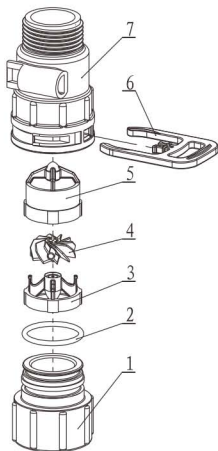

5447018 Flow Meter

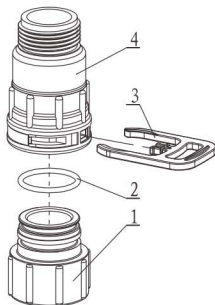

5457002 Animated Connector

| 5447018 Flow Meter | | | |
|--------------------|--------------------|----------|----------|
| Item No. | Description | Part No. | Quantity |
| 1 | Animated Nut | 8945001 | 1 |
| 2 | O-ring | 8378081 | 1 |
| 3 | Impeller supporter | 5115022 | 1 |
| 4 | Impeller | 5436010 | 1 |
| 5 | Impeller supporter | 5115021 | 1 |
| 6 | Clip | 8270004 | 1 |
| 7 | Shell | 8002001 | 1 |

| 5457002 Animated Connector | | | |
|----------------------------|--------------|----------|----------|
| Item No. | Description | Part No. | Quantity |
| 1 | Animated Nut | 8945001 | 1 |
| 2 | O-ring | 8378081 | 1 |
| 3 | Clip | 8270004 | 1 |
| 4 | Connector | 8458038 | 1 |
| | | | |
| | | | |

MODEL:63504-F63C1/63604-F63C3/73504-F68C1/73604-F68C3

F63C3/63604 & F68C3/73604 Valve Body Assembly

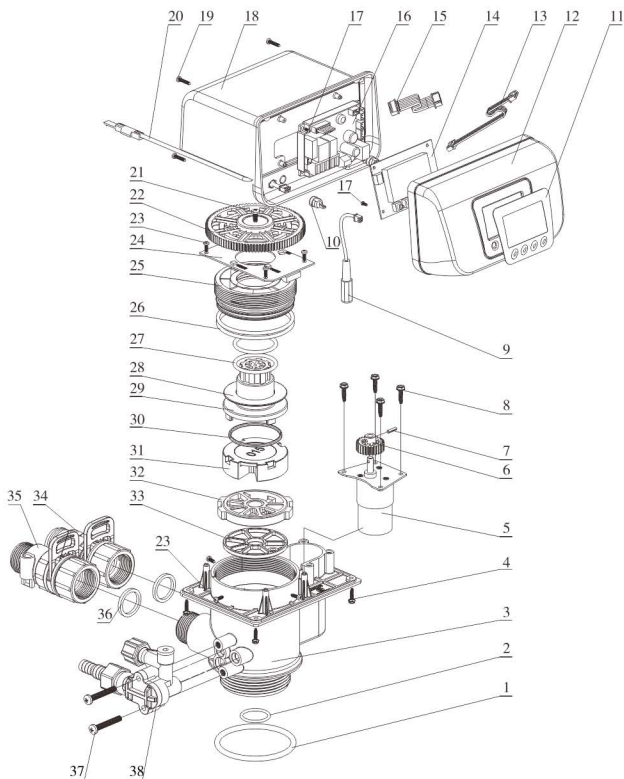

MODEL:63504-F63C1/63604-F63C3/73504-F68C1/73604-F68C3

F63C3 /F63C1 Valve Body Components (Item No. 20, 34, 35 only for F63C3)

| Item No. | Description | Part No. | Quantity | Item No. | Description | Part No. | Quantity |
|----------|-------------------------|----------|----------|----------|------------------------|----------|----------|
| 1 | O-ring 73×5.3 | 8378143 | 1 | 20 | Probe Wire | 6386014 | 1 |
| 2 | O-ring 25.8×2.65 | 8378078 | 1 | 21 | Screw, Cross ST3.9×13 | 8909013 | 1 |
| 3 | Valve Body (ABS+GF10) | 5022033 | 1 | 22 | Big Gear, Driven | 5241002 | 1 |
| | Valve Body (PPO+GF20) | 5022034 | | 23 | Screw, Cross ST2.9×9.5 | 8909008 | 7 |
| 4 | Screw, Cross ST3.9×16 | 8909016 | 4 | 24 | Locating Board | 6380001 | 1 |
| 5 | Motor | 6158011 | 1 | 25 | Fitting Nut | 8092004 | 1 |
| 6 | Small Gear, Motor | 8241003 | 1 | 26 | O-ring 73×3.55 | 8378128 | 2 |
| 7 | Pin | 8993003 | 1 | 27 | O-ring 37.7×3.55 | 8378184 | 2 |
| 8 | Screw, Cross ST3.9×16 | 8909044 | 4 | 28 | Anti-friction Washer | 8216004 | 1 |
| 9 | Wire for Power | 5513001 | 1 | 29 | Shaft | 8258004 | 1 |
| 10 | Cable Clip | 8126004 | 2 | 30 | Moving Seal Ring | 8370001 | 1 |
| 11 | Label | 8865002 | 1 | 31 | Moving Disk | 8459001 | 1 |
| 12 | Front Cover | 8300001 | 1 | 32 | Fixed Disk | 8469001 | 1 |
| 13 | Wire for Display Board | 5512001 | 1 | 33 | Seal Ring | 8370002 | 1 |
| 14 | Display Board | 6381003 | 1 | 34 | Animated Connector | 5457002 | 1 |
| 15 | Wire for Locating Board | 5511001 | 1 | 35 | Flow Meter | 5447018 | 1 |
| 16 | Control Board | 6382003 | 1 | 36 | Seal Ring | 8371001 | 2 |
| 17 | Screw, Cross ST2.2×6.5 | 8909004 | 4 | 37 | Screw, Cross M5×35 | 8902017 | 2 |
| 18 | Dust Cover | 8005006 | 1 | 38 | Old Injector (6300) | 5468009 | 1 |
| 19 | Screw, Cross ST2.9×16 | 8909010 | 4 | | New Injector (6800) | 5468115 | |

MODEL:63504-F63C1/63604-F63C3/73504-F68C1/73604-F68C3

F68C3/F68C1 Valve Body Components (Item No. 20, 34, 35 only for F68C3)

| Item No. | Description | Part No. | Quantity | Item No. | Description | Part No. | Quantity |
|----------|-------------------------|----------|----------|----------|------------------------|----------|----------|
| 1 | O-ring 73×5.3 | 8378143 | 1 | 20 | Probe Wire | 6386014 | 1 |
| 2 | O-ring 25.8×2.65 | 8378078 | 1 | 21 | Screw, Cross ST3.9×13 | 8909013 | 1 |
| 3 | Valve Body (ABS+GF10) | 5022022 | 1 | 22 | Big Gear, Driven | 5241002 | 1 |
| | Valve Body (PPO+GF20) | 5022023 | | 23 | Screw, Cross ST2.9×9.5 | 8909008 | 7 |
| 4 | Screw, Cross ST3.9×16 | 8909016 | 4 | 24 | Locating Board | 6380006 | 1 |
| 5 | Motor | 6158011 | 1 | 25 | Fitting Nut | 8092004 | 1 |
| 6 | Small Gear, Motor | 8241003 | 1 | 26 | O-ring 73×3.55 | 8378128 | 2 |
| 7 | Pin | 8993003 | 1 | 27 | O-ring 37.7×3.55 | 8378184 | 2 |
| 8 | Screw, Cross ST3.9×16 | 8909044 | 4 | 28 | Anti-friction Washer | 8216004 | 1 |
| 9 | Wire for Power | 5513001 | 1 | 29 | Shaft | 8258004 | 1 |
| 10 | Cable Clip | 8126004 | 2 | 30 | Moving Seal Ring | 8370001 | 1 |
| 11 | Label | 8865002 | 1 | 31 | Moving Disk | 8459015 | 1 |
| 12 | Front Cover | 8300001 | 1 | 32 | Fixed Disk | 8469014 | 1 |
| 13 | Wire for Display Board | 5512001 | 1 | 33 | Seal Ring | 8370029 | 1 |
| 14 | Display Board | 6381003 | 1 | 34 | Animated Connector | 5457002 | 1 |
| 15 | Wire for Locating Board | 5511001 | 1 | 35 | Flow Meter | 5447018 | 1 |
| 16 | Control Board | 6382003 | 1 | 36 | Seal Ring | 8371001 | 2 |
| 17 | Screw, Cross ST2.2×6.5 | 8909004 | 4 | 37 | Screw, Cross M5×35 | 8902017 | 2 |
| 18 | Dust Cover | 8005006 | 1 | 38 | Old Injector (6300) | 5468009 | 1 |
| 19 | Screw, Cross ST2.9×16 | 8909010 | 4 | | New Injector (6800) | 5468115 | |

MODEL:63504-F63C1/63604-F63C3/73504-F68C1/73604-F68C3

F63G3/63604B and F68G3/73604B Valve Body Assembly

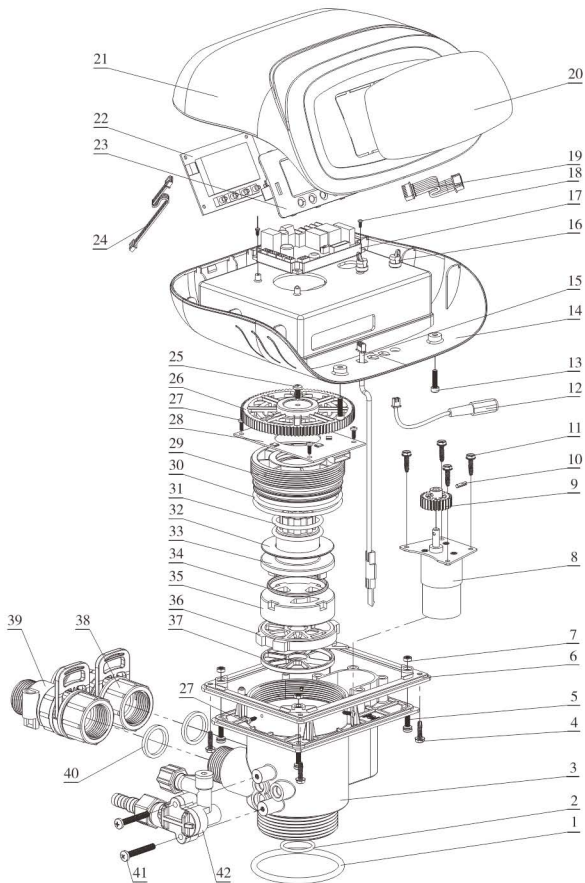

MODEL:63504-F63C1/63604-F63C3/73504-F68C1/73604-F68C3

F63G3/F63G1 Valve Body Components (Item No. 14, 37, 38 only for F63G3)

| Item No. | Description | Part No. | Quantity | Item No. | Description | Part No. | Quantity |
|----------|-------------------------|----------|----------|----------|------------------------|----------|----------|
| 1 | O-ring 73×5.3 | 8378143 | 1 | 22 | Display Board | 6381003 | 1 |
| 2 | O-ring25.8×2.65 | 8378078 | 1 | 23 | Toggle | 8109027 | 1 |
| 3 | Valve Body (ABS+GF10) | 5022033 | 1 | 24 | Wire for Display Board | 5512001 | 1 |
| | Valve Body (PPO+GF20) | 5022034 | | 25 | Screw, Cross ST3.9×13 | 8909013 | 1 |
| 4 | Screw, Cross ST3.9×16 | 8909016 | 4 | 26 | Big Gear, Driven | 5241002 | 1 |
| 5 | Screw, Cross M4×12 | 8902005 | 4 | 27 | Screw, Cross ST2.9×9.5 | 8909008 | 7 |
| 6 | Junction Plate | 8152013 | 1 | 28 | Locating Board | 6380001 | 1 |
| 7 | Hexagon nut | 8940002 | 4 | 29 | Fitting Nut | 8092004 | 1 |
| 8 | Motor | 6158011 | 1 | 30 | O-ring 73×3.55 | 8378128 | 2 |
| 9 | Small Gear, Motor | 8241003 | 1 | 31 | O-ring 37.7×3.55 | 8378184 | 2 |
| 10 | Pin | 8993003 | 1 | 32 | Anti-friction Washer | 8216004 | 1 |
| 11 | Screw, Cross ST3.9×16 | 8909044 | 4 | 33 | Shaft | 8258004 | 1 |
| 12 | Wire for Power | 5513001 | 1 | 34 | Moving Seal Ring | 8370001 | 1 |
| 13 | Socket Head Cap Screws | 8902016 | 2 | 35 | Moving Disk | 8459001 | 1 |
| 14 | Dust Cover | 8005019 | 1 | 36 | Fixed Disk | 8469001 | 1 |
| 15 | Probe Wire | 6386022 | 1 | 37 | Seal Ring | 8370002 | 1 |
| 16 | Cable Clip | 8126004 | 2 | 38 | Animated Connector | 5457002 | 1 |
| 17 | Control Board | 6382003 | 1 | 39 | Flow Meter | 5447018 | 1 |
| 18 | Screw, Cross ST3.9×13 | 8909004 | 2 | 40 | Seal Ring | 8371001 | 2 |
| 19 | Wire for Locating Board | 5511001 | 1 | 41 | Screw, Cross M5×35 | 8902017 | 2 |
| 20 | Label | 8865020 | 1 | 42 | Old Injector (6300) | 5468009 | 1 |
| 21 | Front Cover | 5300001 | 1 | | New Injector (6800) | 5468115 | |

MODEL:63504-F63C1/63604-F63C3/73504-F68C1/73604-F68C3

F68G3/F68G1 Valve Body Components (Item No. 15, 38, 39 only for F68G3)

| Item No. | Description | Part No. | Quantity | Item No. | Description | Part No. | Quantity |
|----------|-------------------------|----------|----------|----------|------------------------|----------|----------|
| 1 | O-ring 73×5.3 | 8378143 | 1 | 22 | Display Board | 6381003 | 1 |
| 2 | O-ring25.8×2.65 | 8378078 | 1 | 23 | Toggle | 8109027 | 1 |
| 3 | Valve Body (ABS+GF10) | 5022022 | 1 | 24 | Wire for Display Board | 5512001 | 1 |
| | Valve Body (PPO+GF20) | 5022023 | | 25 | Screw, Cross ST3.9×13 | 8909013 | 1 |
| 4 | Screw, Cross ST3.9×16 | 8909016 | 4 | 26 | Big Gear, Driven | 5241002 | 1 |
| 5 | Screw, Cross M4×12 | 8902005 | 4 | 27 | Screw, Cross ST2.9×9.5 | 8909008 | 7 |
| 6 | Junction Plate | 8152013 | 1 | 28 | Locating Board | 6380006 | 1 |
| 7 | Hexagon nut | 8940002 | 4 | 29 | Fitting Nut | 8092004 | 1 |
| 8 | Motor | 6158011 | 1 | 30 | O-ring 73×3.55 | 8378128 | 2 |
| 9 | Small Gear, Motor | 8241003 | 1 | 31 | O-ring 37.7×3.55 | 8378184 | 2 |
| 10 | Pin | 8993003 | 1 | 32 | Anti-friction Washer | 8216004 | 1 |
| 11 | Screw, Cross ST3.9×16 | 8909044 | 4 | 33 | Shaft | 8258004 | 1 |
| 12 | Wire for Power | 5513001 | 1 | 34 | Moving Seal Ring | 8370001 | 1 |
| 13 | Socket Head Cap Screws | 8902016 | 2 | 35 | Moving Disk | 8459015 | 1 |
| 14 | Dust Cover | 8005019 | 1 | 36 | Fixed Disk | 8469014 | 1 |
| 15 | Probe Wire | 6386022 | 1 | 37 | Seal Ring | 8370029 | 1 |
| 16 | Cable Clip | 8126004 | 2 | 38 | Animated Connector | 5457002 | 1 |
| 17 | Control Board | 6382003 | 1 | 39 | Flow Meter | 5447018 | 1 |
| 18 | Screw, Cross ST3.9×13 | 8909004 | 2 | 40 | Seal Ring | 8371001 | 2 |
| 19 | Wire for Locating Board | 5511001 | 1 | 41 | Screw, Cross M5×35 | 8902017 | 2 |
| 20 | Label | 8865020 | 1 | 42 | Old Injector (6300) | 5468009 | 1 |
| 21 | Front Cover | 5300001 | 1 | | New Injector (6800) | 5468115 | |

Structure Chart of New Injector:

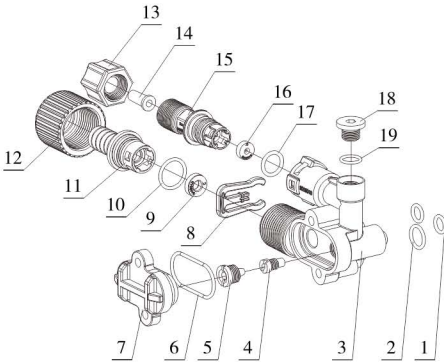

New Injector (6800 seires) Components:

| Item No. | Description | Part No. | Quantity | Item No. | Description | Part No. | Quantity |
|----------|-------------------|----------|----------|----------|--------------|----------|----------|
| 1 | O-ring 7.5×1.8 | 8378016 | 2 | 11 | Connector | 8458064 | 1 |
| 2 | O-ring 10.82×1.78 | 8378012 | 1 | 12 | Animated Nut | 8945025 | 1 |
| 3 | Injector Body | 8008010 | 1 | 13 | Nut Nex. Hd | 8940001 | 1 |
| 4 | Throat | Optional | 1 | 14 | Tube | 8457004 | 1 |
| 5 | Nozzle | Optional | 1 | 15 | Connector | 8458068 | 1 |
| 6 | O-ring 30×1.8 | 8378025 | 1 | 16 | BLFC | Optional | 1 |
| 7 | Injector Cover | 8315001 | 1 | 17 | O-ring 11×2 | 8378169 | 1 |
| 8 | Clip | 8270010 | 1 | 18 | Plug | 8323002 | 1 |
| 9 | DLFC | Optional | 1 | 19 | Seal Ring | 8370012 | 1 |
| 10 | O-ring 15×1.8 | 8378179 | 1 | | | | |

Structure Chart of Old Injector:

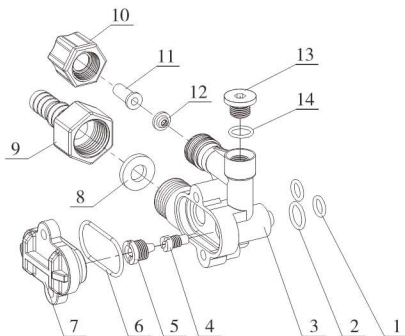

Old Injector (6300 series) Components:

| Item No. | Description | Part No. | Quantity | Item No. | Description | Part No. | Quantity |
|----------|-------------------|----------|----------|----------|-------------|----------|----------|
| 1 | O-ring 7.5×1.8 | 8378016 | 2 | 8 | DLFC | 8468007 | 1 |
| 2 | O-ring 10.82×1.78 | 8378012 | 1 | 9 | Connector | 8458017 | 1 |
| 3 | Injector Body | 8008001 | 1 | 10 | Nut Nex. Hd | 8940001 | 1 |
| 4 | Throat | 8467009 | 1 | 11 | Tube | 8457004 | 1 |
| 5 | Nozzle | 8454009 | 1 | 12 | BLFC | 8468002 | 1 |
| 6 | O-ring 30×1.8 | 8378025 | 1 | 13 | Plug | 8323002 | 1 |
| 7 | Injector Cover | 8315001 | 1 | 14 | Seal Ring | 8370003 | 1 |

4. Warranty Card

Dear client:

This warranty card is the guarantee proof of Runxin brand multi-functional flow control valve. It is kept by client self. You could get the after-sales services from the supplier which is appointed by Runxin manufacturer. Please keep it properly. It couldn't be retrieved if lost.

It couldn't be repaired free of charge under the below conditions:

1. Guarantee period expired.(One year);
2. Damage resulting from using, maintenance, and keeping that are not in accordance with the instruction.
3. Damage resulting from repairing not by the appointed maintenance personnel.
4. Content in guarantee proof is unconfirmed with the label on the real good or be altered.
5. Damage resulting from force majeure.

| | | | | |
|-----------------------|---|------------------------|--|---------------------------|
| Product Name |  Multi-functional Flow Control Valve for Water Treatment Systems | | | |
| Model | | Code of Valve Body | | |
| Purchase Company Name | | Tel/Cel. | | |
| Problem | | | | |
| Solution | | | | |
| Date of Repairing | | Date of Accomplishment | | Maintenance Man Signature |

When product needs warranty service, please contact with your direct supplier firstly, after got permission, then fill in the below content and send this card together with the product to the appointed suppliers or Runxin company.

| | | | | |
|---|---|---------------------------|--|--|
| End-user Company Name | | Tel/Cel. | | |
| Purchase Company Name | | Tel/Cel. | | |
| Model | | Code of Valve Body | | |
| Tank Size ϕ × | Resin Tank Size L | Raw Water Hardness Mmol/L | | |
| Water Source: Ground-water <input type="checkbox"/> Tap Water <input type="checkbox"/> | Water Treatment Capacity m ³ | Backwash Time min | | |
| Brine & Slow Rinse Time min | Brine Refill Time min | Fast Rinse Time min | | |
| Problem Description | | | | |



WENZHOU RUNXIN MANUFACTURING MACHINE CO.,LTD

ADD: NO.169, RUNXIN ROAD, SHANFU TOWN, WENZHOU, ZHEJIANG, CHINA.

TEL.:0086-577-88630038, 88576512, 85956057 FAX:0086-577-88633258

E-MAIL: sales@run-xin.com <http://www.run-xin.com>