



International Patent Public No.:WO 2006/007772

China Patent No.:ZL201410025506.8

ZL02220153.X,

US Patent No.: 7549446

India Patent No.: 232582

Russia Patent No.: 2349819

South Korea Patent No.: 10-0914137

Mexico Patent No.: 268581

Australia Patent No.: 2005263257

Philippine Patent No.: 1-2006-502553

Taiwan Patent No.: M287896

Multi-functional Flow Control Valve for Water Treatment Systems

53515 (F99B1)

53615 (F99B3)

63515 (F99A1)

63615 (F99A3)

73515 (F99D1)

73615 (F99D3)

User Manual

Please read this manual in details
before using the valve and keep it properly in order to consult in the future.

0WRX.466.596

Before the valve put into use, please fill in the below content so as to help us to refer in the future.

Softener System Configuration

Tank Size: Dia. _____ mm, Height _____ mm;

Resin Volume _____ L; Brine Tank Capacity _____ L;

Hardness of Raw Water _____ mmol/L;

Pressure of Inlet Water _____ MPa;

Control Valve Model _____ ; Number _____ ;

The Specification of Drain Line Flow Control _____ ;

Injector No. _____ .

Water Source: Ground-water Filtered Ground-water Tap Water Other _____ .

Parameter Set

Parameter	Unit	Factory Default	Actual Value
Time of Day	h:m	Random	
Control Mode A-01/02/03/04 (Only suited for 63615/73615), 53515 only have A-01/02	/	A-01	
Water Treatment Capacity (Meter type)	m ³	200.0	
Service Days (Time clock type, by days)	D	03	
Regeneration Time	h:m	02:00	
Backwash Time	min:sec	10:00	
Interval Backwash Times (Only suited for 73515/73615)	/	F-00	
Rinsing Frequency(Only suited for 53515/53615)	/	F-00	
Brine Draw Time (It is not suit for 53515/53615)	min:sec	60:00	
Slow Rinse Time(It is not suit for 53515/53615)	min:sec	45:00	
Fast Rinse Time	min:sec	10:00	
Brine Refill Time(It is not suit for 53515/53615)	min:sec	05:00	
Maximum Interval Regeneration Days (Meter type)	D	30	
Output Mode b-01/2	/	b-01	

● If there is no special requirement when product purchase, we choose 3# drain line flow control (With 2 holes of $\phi 6$) and 3# injector (7703) for the standard configuration for 63515/63615/73515/73615.

Catalogue

Notice.....	1
1.Product Overview.....	2
1.1.Main Application & Applicability.....	2
1.2.Product Characteristics.....	2
1.3.Service Condition.....	5
1.4.Product Structure and Technical Parameters.....	6
1.5. Installation.....	9
2.Basic Setting & Usage.....	10
2.1.The Function of PC Board.....	10
2.2.Basic Setting & Usage.....	14
3.Applications.....	18
3.1.Flow Chart.....	18
3.2.The Function and Connection of PC Board.....	20
A. Signal Output Connector.....	21
B. Interlock.....	24
C. Pressure Relief Output.....	24
D. Remote Handling Connector.....	24
E. Interlock System.....	25
F. Series System.....	25
3.3.System Configuration and Flow Rate Curve.....	26
3.4.Parameter Settlement.....	28
3.5.Parameter Enquiry and Setting.....	30
3.6.Trial Running.....	33
3.7.Trouble-Shooting.....	35
3.8.Assembly & Parts.....	38
4.Warranty Card.....	45

Notice

- To ensure normal operation of the valve, please consult with professional installation or repairing personnel before use it.
- If there are any of pipeline engineering and electric works, there must be finished by professional at the time of installation.
- Do not use the control valve with the water that is unsafe or unknown quality.
- Depending on the changing of working environment and water requirement, each parameter of softener should be adjusted accordingly.
- When the water treatment capacity is too low, please check the resin. If the reason is shortage of resin, please add; if the resin is turn to reddish brown or broken, please replace.
- Test water periodically to verify that system is performing satisfactorily.
- Ensure that there is solid salt all the time in the brine tank in the course of using, when this valve is used for softening. The brine tank should be added the crystalline coarse salt only, at least 99.5% pure, forbidding use the small salt.
- Do not put the valve near the hot resource, high humidity, corrosive, intense magnetic field or intense vibrations environment. And do not leave it outside.
- Forbidden to carry the injector body. Avoid using injector body as support to carry the system.
- Forbidden to use the brine tube or other connectors as support to carry the system.
- Please use this product under the water temperature between 5~50℃, water pressure 0.2~0.6MPa. Failure to use this product is under such conditions voids the warranty.
- If the water pressure exceeds 0.6Mpa, a pressure reducing valve must be installed before the water inlet. While, if the water pressure is under 0.2MPa, a booster pump must be installed before the water inlet.
- PPR pipes, corrugated pipes, or UPVC pipes are recommended for pipe installation and aluminum-plastic pipes should be avoided.
- Do not let children touch or play, because carelessness operating may cause the procedure changed.
- When the attached cables or transformer of this product is broken, they must be changed to the one that is from our factory.

1. Product Overview

1.1. Main Application & Applicability

Used for softening, demineralization or filtration water treatment systems

53515/53615(Filtration)

Be suitable for swimming pool filtration system

Filtration system

Activated carbon filter or sand filter for RO pretreatment system.

63515/63615 (Down-flow regeneration)

73515/73615(Up-flow regeneration)

Be suitable for ion-exchange equipment, the raw water hardness ≤ 6.5 mmol/L.

Boiler softening water system

RO pretreatment softening system, etc.

1.2. Product Characteristics

● Simple structure and reliable sealing

It adopts hermetic head faces with high degree pottery and corrosion resistance for opening and closing. It combines with Service, Backwash, Brine Draw, Slow Rinse, Fast Rinse and Brine Refill.

● No water passes the valve during regeneration in single tank type

● Brine refill is controlled by electronic ball valve

During service, electronic ball valve will control to start the brine refill. so as to shorten the regeneration cycle time. 63515/63615 brine refilled with hard water, 73515/73615 brine refilled with soft water.

● Variety of installation methods

Uses side- mounted connector to change the valve from top-mounted to side-mounted. Screen is moveable.

● Manual function

Realize regeneration immediately by pressing “” at any time.



● Long outage indicator

If outage overrides 3 days, the time of day indicator “12:12” will flash to remind people to reset new time of day. The other set parameters do not need to reset. The process will continue to work after power on.





● LED dynamic screen display

The stripes on dynamic screen flash, they indicate the control valve is in service; otherwise, it is in regeneration cycle.

● **Buttons lock**

No operations to buttons on the controller within 1 minute, button lock indicator lights on which represents buttons are locked. Before operation, press and hold the “” and “” buttons for 5 seconds to unlock. This function can avoid incorrect operation.

● **It can choose all models by program selection**

When all symbols light on, press and hold “” and “” buttons more than 2 seconds to enter the menu of valve model selection. Press “” and “” buttons to select the requested model, then press “” button to save the selection. Reconnect the power, the model will be showed on display board.

● **Interlock function**

It has a function of interlock to realize only one valve in regeneration but the other valves are in service while several valves parallel in system. In multi-steps treatment systems such as RO pre-treatment, when several valves are in series, there is only one valve in regeneration or washing to ensure pass water all the times. (Application refers to Figure 3-9)

● **Signal output**

There is a signal output connector on main control board. It is applied for controlling external wiring (Refer to Figure 3-1 to Figure 3-8).

There are two kinds of output modes: b-01 mode: Turn on when start regeneration and shut off at the end of regeneration; b-02 mode: Signal is only available at intervals of each status.

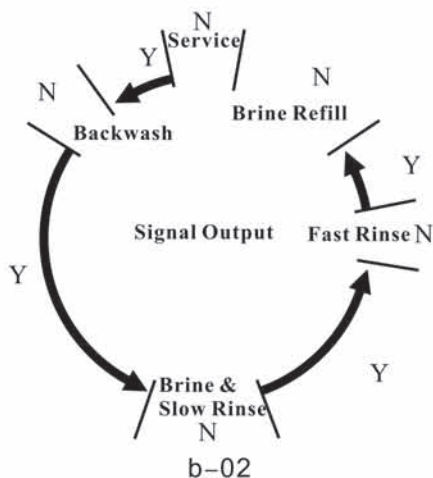
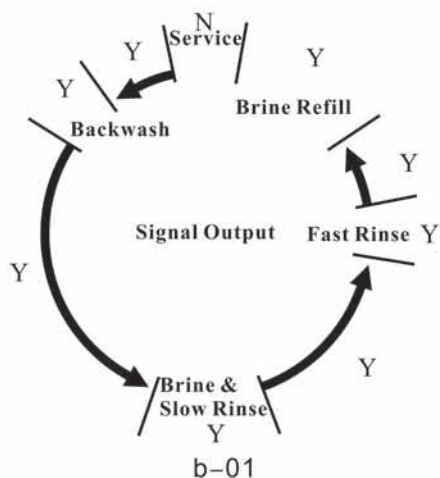

● **Remote handling input**

This connector can receive external signal, used together with PLC, and computer etc. to control the valve. (Application refers to Figure3-11)

● **Pressure relief output**

The valve will cut off feeding water to drain line when it switches in regeneration cycles (Same as signal output b-02). Thus in some water treatment system, e.g. Deep Well, one booster pump was installed on the inlet to increase the system water feeding pressure, this cut-off will cause pressure on inlet rising too fast to damage the valve. Pressure Relief Output can be used to avoid this problem. (Application refers to Figure3-10)

● **All parameters can be modified**

According to the water quality and usage, the parameters in the process can be adjusted.

● **Four kinds of meter type can be selected (Suit for 63615/73615)**

Mode	Name	Instruction
A-01	Meter Delayed	Regenerate on the day although the available volume of treated water drops to zero (0). Regeneration starts at the regeneration time.
A-02	Meter Immediate	Regenerate immediately when the available volume of treated water drops to zero (0).
A-03	Intelligent Meter Delayed	Meter Delayed Regeneration Type, but by setting Resin Volume, Feed Water Hardness, Regeneration Factor, the controller will calculate the System Capacity. Regeneration mode is the same as A-01.
A-04	Intelligent Meter Immediate	Meter Immediately Regeneration Type, but by setting Resin Volume, Feed Water Hardness, Regeneration Factor, the controller will calculate the System Capacity. Regeneration mode is the same as A-02.

● **Maximum interval regeneration days (Suit for 63615/73615)**

Under the situation of service reaching the setting days and the volume not yet, it could enter into regeneration process or fast rinse forcibly when current time is the same as regeneration time.

1.3. Service Condition

Runxin valve should be used under the below conditions:

Items		Requirement
Working conditions	Water pressure	0.2MPa~0.6MPa
	Water temperature	5℃~50℃
Working environment	Environment temperature	5℃~50℃
	Relative humidity	≤95%(25℃)
	Electrical facility	Ac100~240V/50~60Hz
Inlet water quality	Water turbidity	Filter (53515/53615)<20FTU Down-flow regeneration softener (63515/63615)<5FTU Up-flow regeneration softener (73515/73615)<2FTU
	Water hardness	First Grade Na ⁺ <6.5mmol/L; Second Grade Na ⁺ <10mmol/L
	Free chlorine	<0.1mg/L
	Iron ²⁺	<0.3mg/L
	CODMn	<2mg/L(O ₂)

In the above table, First Grade Na⁺ represents First Grade Na⁺ Exchanger. Second Grade Na⁺ represents Second Grade Na⁺ Exchanger.

● When the water turbidity exceeds the conditions, a filter should be installed on the inlet of control valve.

● When the water hardness exceeds the conditions, the outlet water hardness will hardly reach the requirement of boiler feed water (0.03 mmol/L). It is suggested to adopt second grade softener.

1.4. Product Structure and Technical Parameters

A. Product dimension (The appearance is just for reference. It is subjected to the real product.)

Structure of 53615

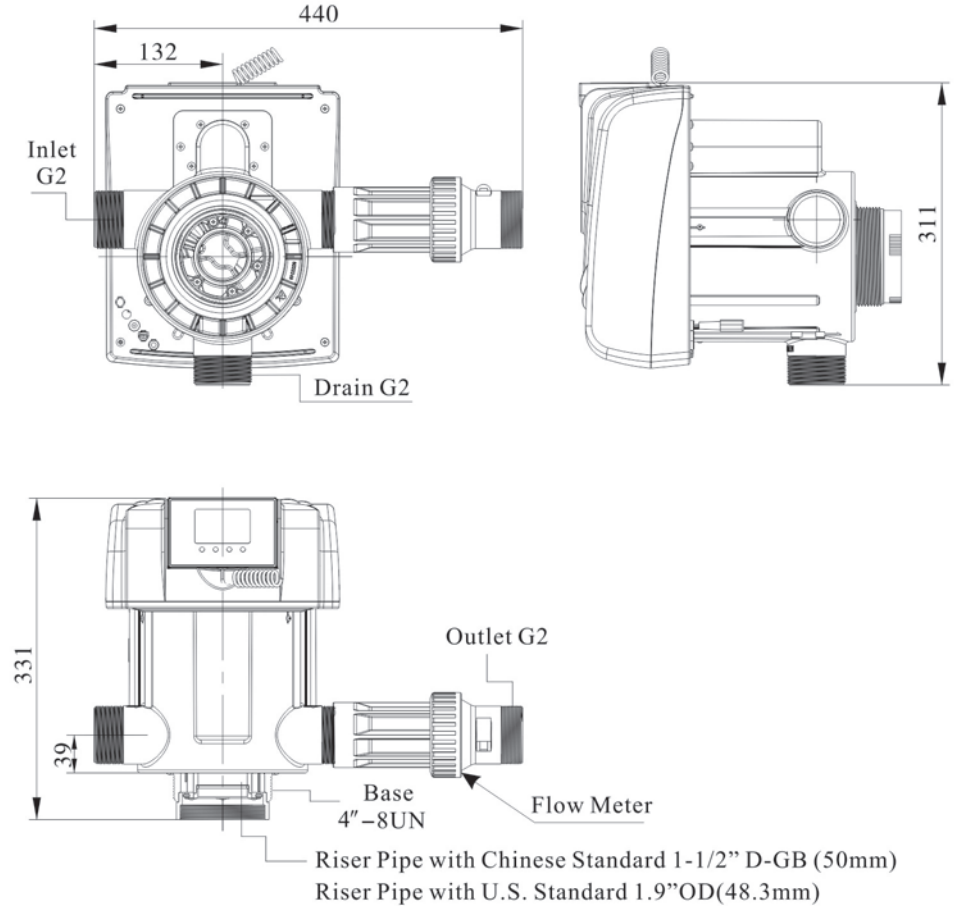

Remark:

Remove the flow meter from 53615, it will be 53515.

Structure of 63615

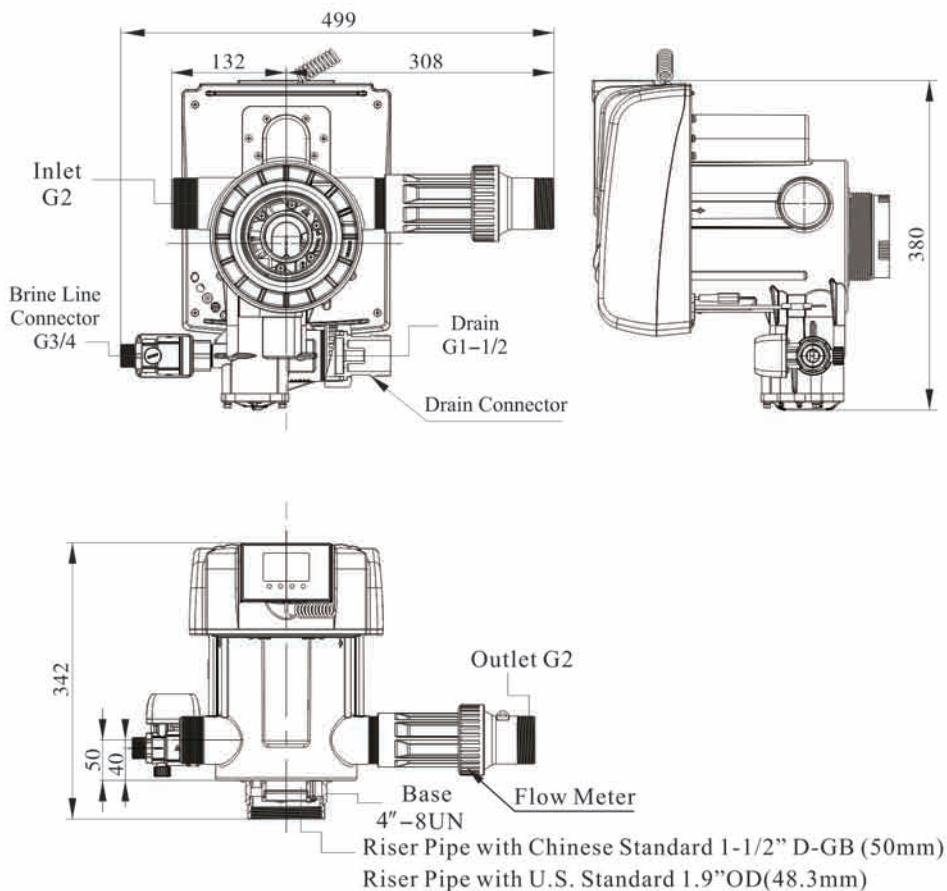

Remark:

Remove the flow meter from 63615, it will be 63515.

Structure of 73615

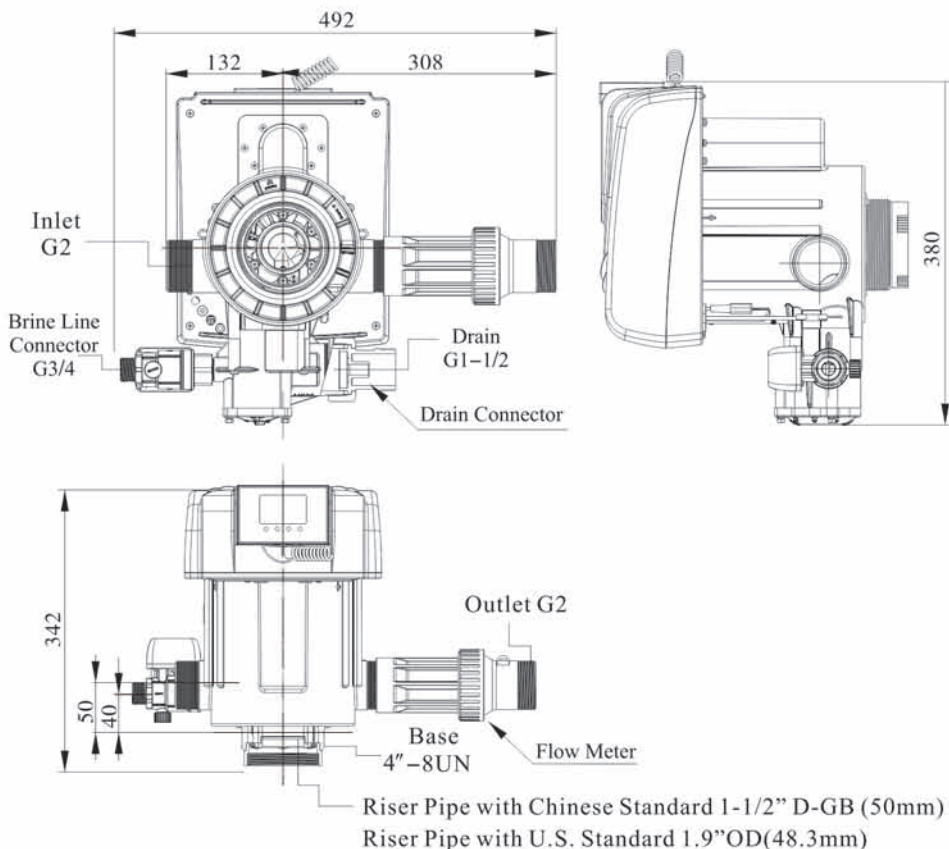

Remark:
Remove the flow meter from 73615, it will be 73515.

B. Technical parameter

Transformer Output: DC24V/1.5A

Model	Connector Size					Flow Rate m ³ /h @0.2MPa	Remark
	Inlet/ Outlet	Drain	Brine Line Connector	Base	Riser Pipe		
53515	2" M	2" M	/	4" -8UN	1-1/2" D-GB (Outer diameter 50mm) or 1.9" OD	Refer to flow Rate on P27	Filter, Meter type
53615					(Outer diameter 48.3mm)		Filter,Time Clock type

63615	2" M	1.5" M	3/4" M	4" -8UN	1-1/2" D-GB (Outer diameter 50mm) or 1.9" OD	15	DF softener, meter type
63515							DF softener, time clock type
73615	2" M	1.5" M	3/4" M	4" -8UN	1-1/2" D-GB (Outer diameter 50mm) or 1.9" OD	15	UF softener, meter type
73515							UF softener, time clock type

Remark: M—Male F—Female

1.5.Installation

A. Installation notice

Before installation, read all those instructions completely. Then obtain all materials and tools needed for installation.

The installation of product, pipes and circuits should be accomplished by professional to ensure the product can operate normally.

Perform installation according to the relative pipeline regulations and the specification of Water Inlet, Water Outlet, Drain Outlet, and Brine Line Connector.

B. Device location

- ① The filter or softener should be located close to drain.
- ② Ensure the unit is installed in enough space for operating and maintenance.
- ③ Brine tank needs to be close to softener.
- ④ The unit should be kept away from the heater, and not be exposed to outdoor. Sunshine or rain will cause the system damage.
- ⑤ Please avoid installing the system in circumstance of acid/alkaline, magnetic or strong vibration circumstance, because above factors will cause the system disorder.
- ⑥ Do not install the filter or softener, drain pipeline or overflow pipe in circumstance which temperature may drop below 5°C, or above 45°C.
- ⑦ Install the system in the place where with the minimum loss in case of water leakage.

C. Pipeline installation (Take 63615 as an example)

① Install control valve

a. As the Figure 1-1 shows, select the riser pipe with 50mm OD, glue the riser pipe to the bottom strainer and put it into the mineral tank, cut off the exceeding pipe out of tank top opening and make external rounding.

b. Fill the resin to the tank, and the height is accordance with the design code.

c. Install the top distributor to the valve.

d. Insert the riser tube into control valve and screw tight control valve.

Note:

- The length of riser pipe should be neither 2mm higher nor 5mm lower than tank top opening, and its top end should be rounded to avoid damage of O-ring inside the valve.

- Avoid filling floccules substance together with resin to the mineral tank.

- Avoid O-ring inside control valve fall out while rotating it on the tank.

② Install flow meter

As Figure 1-2 shows, put the sealing ring into nut of flow meter, screw in water outlet; insert the sensor into flow meter.

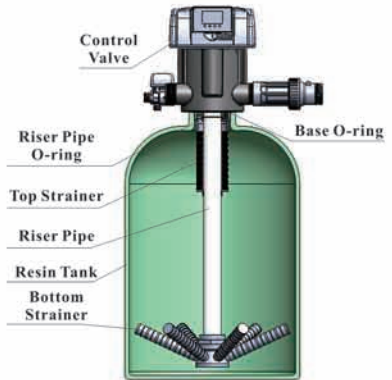

Figure 1-1

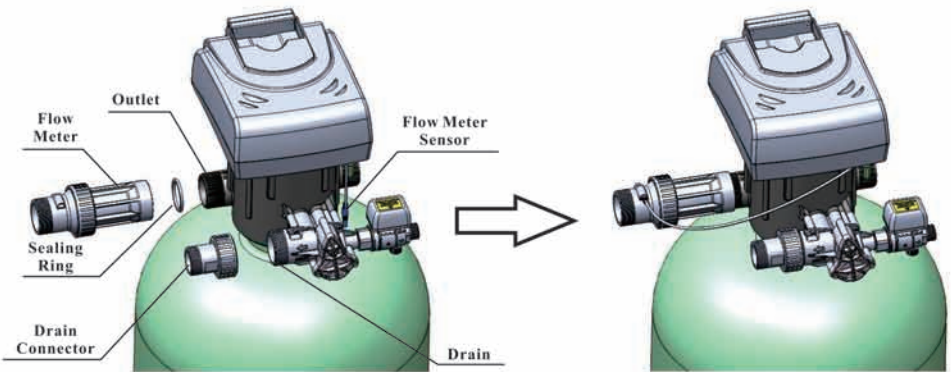

Figure 1-2

③ Pipeline connection

a. As Figure 1-3 shows, install a pressure gauge in water inlet.

b. Install valves A.B.C.D in inlet, outlet, inlet pipeline and outlet pipeline. Valve D is a sampling valve.

c. Inlet pipeline should be in parallel with outlet pipeline. Support inlet and outlet pipeline with fixed holder.

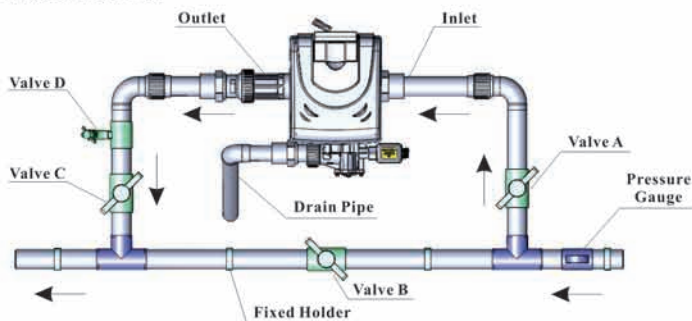

Figure 1-3

Note:

- If making a soldered copper installation, do all sweat soldering before connecting pipes to the valve. Torch heat will damage plastic parts.
- When turning threaded pipe fittings onto plastic fitting, do not use excessive force to make threads misaligned or break valve.
- If the valve belongs to time clock type (63515/73515), there are no step ②.

④ Install drain pipeline (If no special requirement, the standard DLFC is No.7703)

a. Based on the table on P26, if tank diameter is 900 mm, install as step d. If the tank size is 750 mm or 1000mm, you need to ask supplier for another injector & DLFC. Install it as below steps.

b. Change 7703 to the corresponding injector for the tank which is 750 mm or 1000mm.

c. Change DLFC to the corresponding DLFC for the tank which is 750 mm or 1000mm.

d. Insert drain line flow control into drain hose connector, then screw it into drain outlet, and lock it.

e. Glue the drain outlet with UPVC (DN40). Put drain outlet pipe to sewer as showed in the Figure 1-4.



Figure 1-4

Note:

● Control valve should be higher than drain outlet, and be better not far from the drain hose.

● Be sure not connect drain with sewer directly, and leave a certain space between them, avoid wastewater being absorbed to the water treatment equipment.

⑤ Connect brine tube

a. As Figure 1-5 shows, use UPVC (DN20) to connect brine valve with brine line connector.

Note:

- Keep brine line short and smooth. Elbow should be less than four to avoid brine tube blocked.
- Brine valve must be installed in brine tank.

b. Connect side-mounted connector (Take 53515 as an example), as figure 1-6 shows:

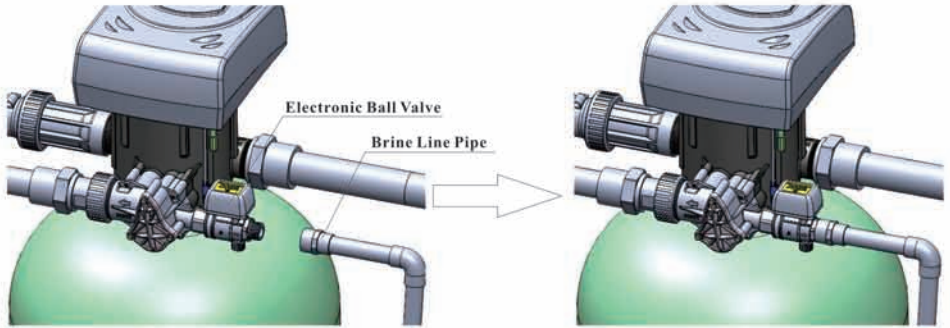

Figure 1-5

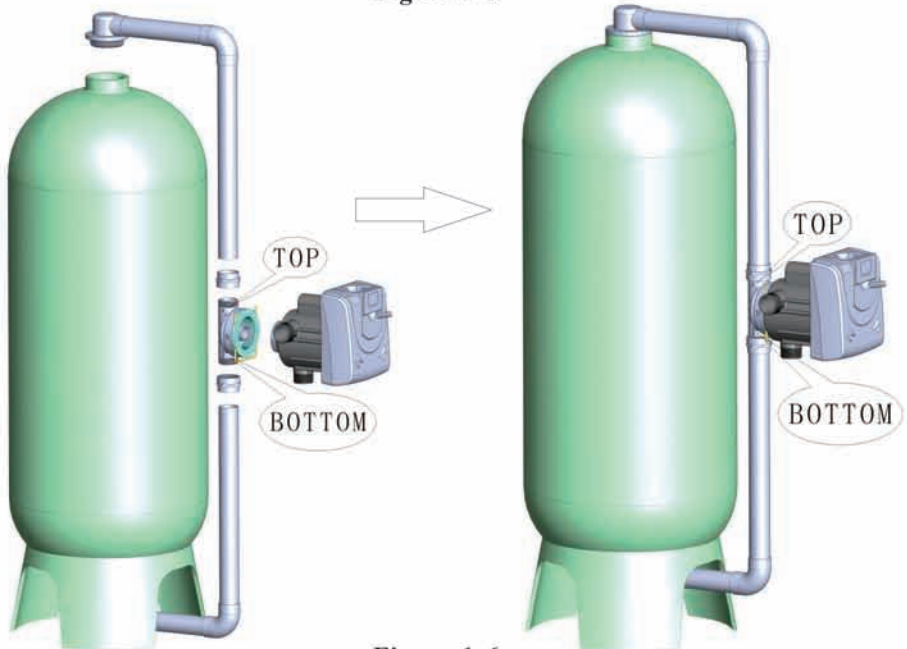
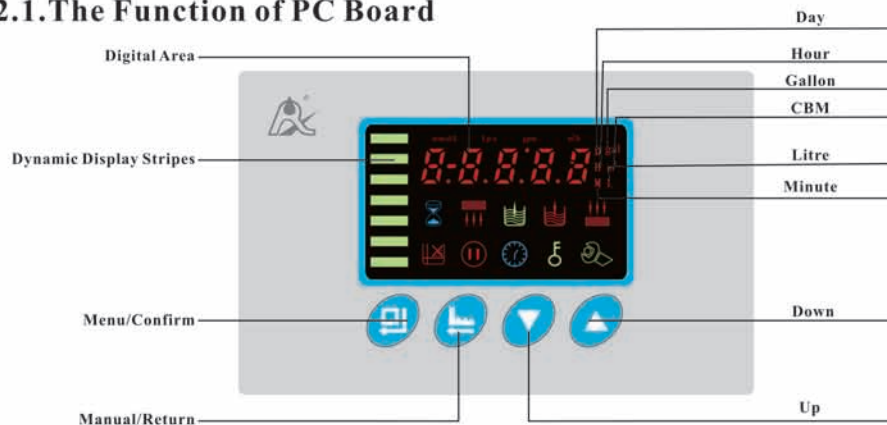

Figure 1-6

2.Basic Setting & Usage

2.1.The Function of PC Board



A. “🕒” Time of day indicator

“🕒” Lights on, display the time of day

B. “🔒” Button lock indicator

● “🔒” lights on, which indicates the buttons are locked. At this moment, it is useless to press any single button. (In any status, no operation in one minute, “🔒” will light on and lock the buttons.)

● Solution: Press and hold both “⬆️” and “⬇️” for 5 seconds until the “🔒” lights off.

C. “🌀” Program mode indicator

● “🌀” Lights on, enter program display mode. Use “⬆️” or “⬇️” to view all values.

● “🌀” Flashes, enter program set mode. Press “⬆️” or “⬇️” to adjust values.

D. “🏠” Menu/Confirm button

● Press “🏠”, “🌀” will light on, enter program display mode and view all values.

● In program display mode, press “🏠”, “🌀” flashes, enter program set mode and adjust values.

● Press “🏠” after all program are set, and then the voice “Di” means all setting are success and return program display mode.



E. “⬆️” Manual/Return button

● Press “⬆️” in any status, it can proceed to next step. (Example: Press “⬆️” in Service status, it will start regeneration cycles instantly if the outlet water is unqualified; Press “⬆️” while it is in Backwash status, it will end Backwash and go to Brine at once.)

● Press “⬆️” in program display mode, and it will return to Service; Press “⬆️”



in program set mode, and it will return program display mode.





- Press “

F. Down “
 - In program display mode, press “

2.2. Basic Setting & Usage

A. Parameter specification

Function	Indicator	Factory Default	Parameter Set Range	Instruction
Time of Day		Random	00:00~23:59	Set the time of day when use; “:” flashes.
Control Mode	A-01	A-01	A-01	Meter Delayed: Regenerate on the day although the available volume of treated water drops to zero (0). Regeneration starts at the regeneration time.
			A-02	Meter Immediate: Regenerate immediately when the available volume of treated water drops to zero (0).
			A-03	Intelligent Meter Delayed: Meter Delayed Regeneration type, but by setting Resin Volume, Feed Water Hardness, Regeneration Factor, the controller will calculate the System Capacity. Regeneration mode same as A-01.
Control Mode			A-04	Intelligent Meter Immediate: Meter Immediately Regeneration Type, but by setting Resin Volume, Feed Water Hardness, Regeneration Factor, the controller will calculate the System Capacity. Regeneration mode same as A-02.
Service Days		1-03D	0 ~ 99Days	Only for Time Clock Type, regeneration by days
Regeneration Time	02:00	02:00	00:00 ~ 23:59	Regeneration time; “:” lights on
Resin Volume	500	500	20-2000	Resin volume in brine tank (L)
Feed Water Hardness	Yd1.2	1.2	0.1-9.9	Feed water hardness (mmol/L)

Exchange Factor	AL.65	0.65	0.30-0.99	Relate to the raw water hardness. When hardness is higher, the factor is smaller.
Water Treatment Capacity		200	0 ~ 9999.9	Water treatment capacity in one circle (m ³)
Interval Backwash Times	F-00	00	00 ~ 20	Only suited for 73515/73615
Rinsing Frequency	F-00	00	00 ~ 20	Only suited for 53515/53615
Backwash Time		10:00	0 ~ 99:59	Backwash time (Minute:Second)
Brine Draw Time		60:00	0 ~ 99:59	Brine draw time (Minute: Second)
Slow Rinse Time	/	45:00	0 ~ 99:59	Slow rinse time (Minute : Second)
Fast Rinse Time		10:00	0 ~ 99:59	Fast rinse time (Minute: Second)
Brine Refill Time		05:00	0 ~ 99:59	Brine refill time (Minute: Second)
Maximum Interval Regeneration Days	H-30	30	0 ~ 40	Regenerate on the day even though the available volume of treated water does not drop to zero (0).
Output Control Mode	b-01	01	01 or 02	Mode b-01: signal will turn on during the regeneration (refer to P3) Mode b-02: Signal is only available at intervals of regeneration cycles and in service. (refer to the P3)

B.Process Display (Take 63615 A-01 as an example)



Figure A



Figure B



Figure C

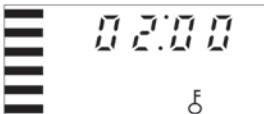

Figure D



Figure E



Figure F

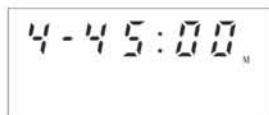

Figure G



Figure H



Figure I

Illustration:

● In Service status, the figure shows Figure A/B/C/D; In Backwash status, it shows Figure E/C; In Brine Draw status, it shows Figure F/C; In Slow Rinse status, it shows Figure G/C; In Fast Rinse status, it shows Figure H/C; In Brine Refill status, it shows Figure J/C. In each status, every figure shows 15 seconds.

● Above displays are taking the Meter Type for example. For the Time Clock Type, it shows the rest days, such as 1-03D.

● The display screen will only show “-00-” when the electrical motor is running.

● The time of day figure “🕒” flash continuously, such as “12:12” flashes, indicates long outage of power. It reminds users to reset the time of day.

● The display will show the error code, such as “-E1-” when the system is in error.

● Working process: Service → Backwash → Brine Draw → Slow Rinse → Fast Rinse → Brine Refill → Service.

C. Usage

After being accomplished installation, parameter setting and trial running, the valve could be put into use. In order to ensure the quality of outlet water can reach the requirement, the user should complete the below works:

① Ensure that there is solid salt all the time in the brine tank when this valve is used for softening. The brine tank should be added the crystalline coarse salt only, at least 99.5% pure, forbidding use the small salt and iodized salt.

② Test the outlet water and raw water hardness at regular time. When the outlet water hardness is unqualified, please press the “🔵” after unlock the buttons and the valve will temporarily regenerate again (It will not affect the original set operation cycle.)

③ When the raw water hardness changes a lot, you can adjust the water treatment capacity as follow:

Press and hold both “⬆️” and “⬇️” for 5 seconds to unlock the buttons. Press “⬇️”, and the “🕒” will light on, then press “⬇️”, the digital area shows the control mode. If it shows A-01 or A-02, press “⬇️” to let the digital area show the given water treatment capacity (If the control mode shows A-03 or A-04, then press “⬇️” four times, the digital area will show the feed water hardness); Press again “⬇️”, “🕒” and digital

flash. Press “▲” or “▼” continuously, reset the capacity value (Or water hardness). Press “⏏” and hear a sound “Di”, then finish the adjustment. Press “⏏” to exit and turn back the service status.

The estimation of water treatment capacity, you can refer to the professional application specification. When select A-03 or A-04 intelligent control mode, the control will automatically calculate the water treatment capacity by setting resin volume, feed water hardness and regeneration factor.

④ For A-01 or A-03 control mode (Delayed regeneration type), please pay attention to whether the time is current or not. If the time is not right, you can adjust as follow: After lifting the lock status, press “⏏”, the “🕒” and “🕒” light on. Then press “⏏”, the “🕒” and hour value flash. Press “▲” or “▼” continuously, reset the hour value; Press “⏏” again, and minute value flash. Press “▲” or “▼” continuously, reset the minute value; Press “⏏” and hear a sound “Di”, then finish the adjustment. Press “⏏” to exit and turn back the service status.

The regeneration parameters have been set when control valve left factory. Generally, it does not need to reset. If you want enquiry and modify the setting, you can refer to the professional application specification.

3.Applications

3.1.Flow Chart

Flow Chart for 63615/63515 down-flow regeneration and 53515/53615 filter.

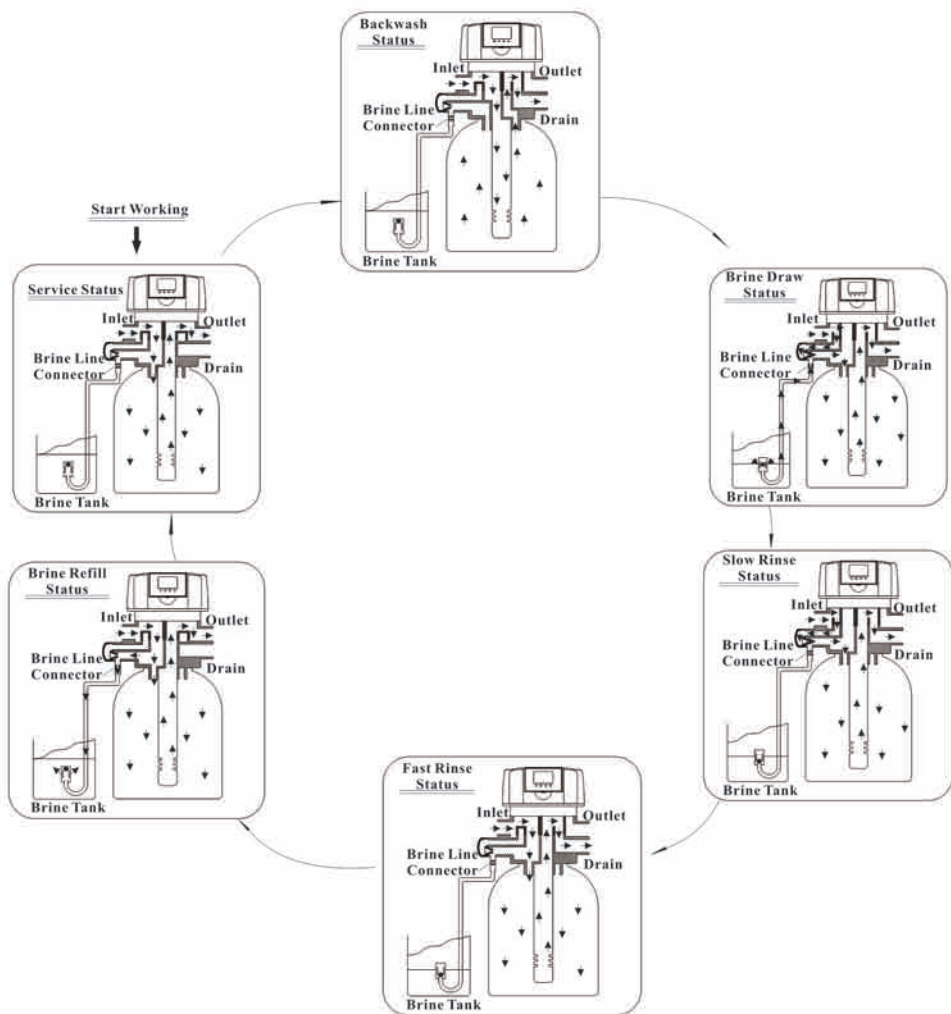

Remark:

For 53515/53615 filter valve, there is only service, backwash and fast rinse status.

Flow Chart for 73615/73515 up-flow regeneration

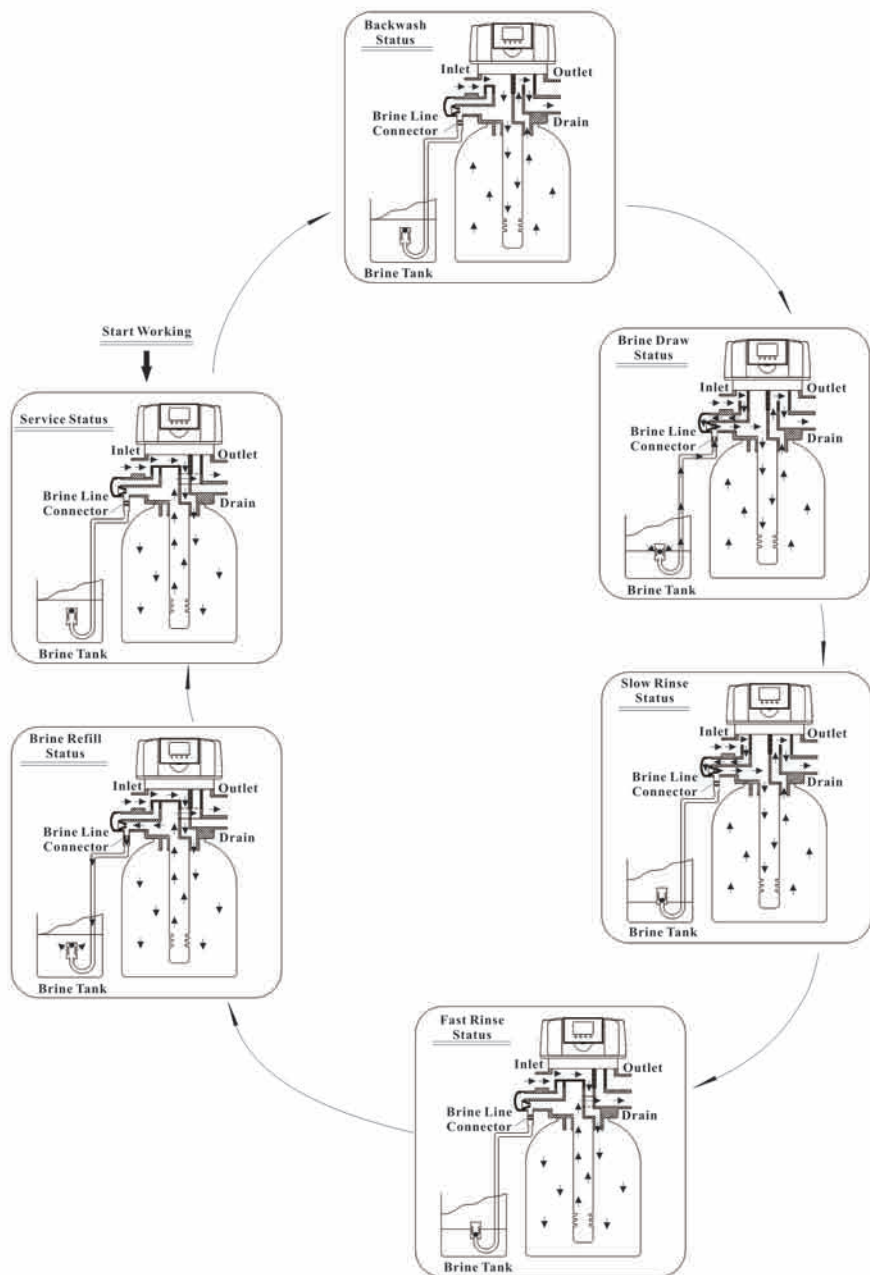

3.2. The Function and Connection of PC Board

Open the front cover of control valve, you will see the main control board and connection ports as below:

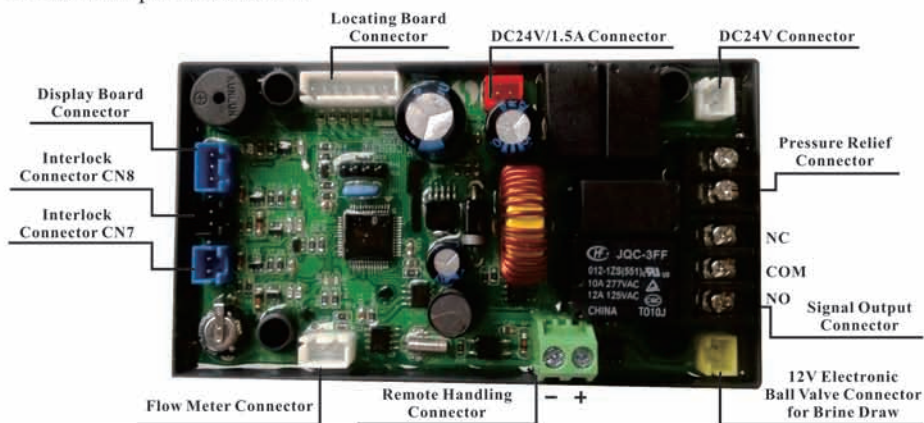

Functions on PC board:

Function	Application	Explanation
Signal Output Connector b-01	Outlet Solenoid Valve	Used in strict requirements regarding no hard water flowing from outlet or controlling the liquid level in water tank.
	Inlet Pump	Increase pressure for regeneration or washing. Use the liquid level controller to control inlet pump to ensure there is water in tank.
Signal Output Connector b-02	Inlet Solenoid Valve or Inlet Pump	When inlet pressure is high, it needs to close water inlet to protect motor when valve is rotating.
Pressure Relief Connector	Control the inlet bypass to release pressure	When valve is rotating, pressure relief connector opened to prevent pressure increasing rapidly.
Interlock Connector	To ensure only one control valve regenerate or wash in system.	Use in RO pre-treatment, water supply together but regeneration in turn, second grade ion exchange equipment, etc.
Remote Handling Connector	Receive signal to make the control valve rotate to next status.	It is used for on-line inspection system, connected with PC to realize automatically or remote controlling valve.

A. Signal Output Connector

1). Control Outlet Solenoid Valve (Set b-01)

① Solenoid valve on outlet controls water level in brine tank.

Instruction: If system strictly requires no hard water flowing from outlet in regeneration cycle (Mainly for no hard water flows out when valve is switching. The control valve turns to or valve in backwash or brine drawing and other regeneration status, there is no hard water flowing out from outlet automatically.), a solenoid valve could be installed on outlet, and the wiring refers to Figure 3-1.

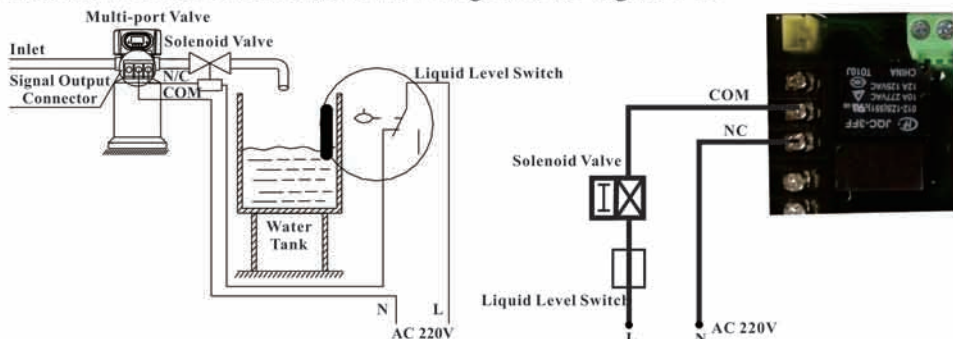

Figure 3-1 Wiring of Solenoid Valve on Outlet

Function:

When valve is in service status, if soft water tank is short of water, solenoid valve will open to supply soft water, but if water tank has enough water, solenoid valve will close, so no soft water supplied to the tank.

When the valve is in backwash or other regeneration status, there is no signal output. So solenoid valve will close, and no raw water flows into soft water tank.

② Control Inlet Solenoid Valve (Set b-02)

Instruction: When inlet pressure exceeds 0.6MPa, install a solenoid valve on inlet. Control mode is b-02. Pressure is relieved when valve switching, the wiring refers to Figure 3-2. As Figure 3-3 shows, it also can use the pressure relief connector to work.

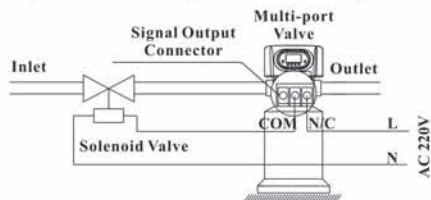

Figure 3-2 Wiring of Solenoid Valve on Inlet

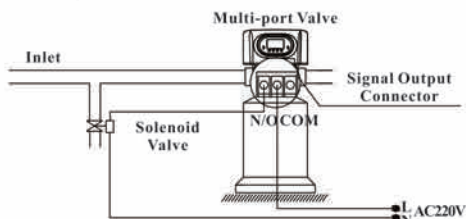

Figure 3-3 Wiring of Pressure Relief Port

Instruction:

When inlet pressure is high, install a solenoid valve on inlet to ensure valve

switches properly. The solenoid valve will open when valve is exactly at status of Service, Backwash, Brine & Slow Rinse, Brine Refill and Fast Rinse. When valve is switching, solenoid valve is closed, no water flows into valve to ensure valve switching properly. It could prevent the problem of mixing water and water hammer.

Use interlock cable to realize valves in parallel and series in same system which is suited for RO pretreatment system or second grade Na⁺ system. The wiring refers to Figure 3-4:

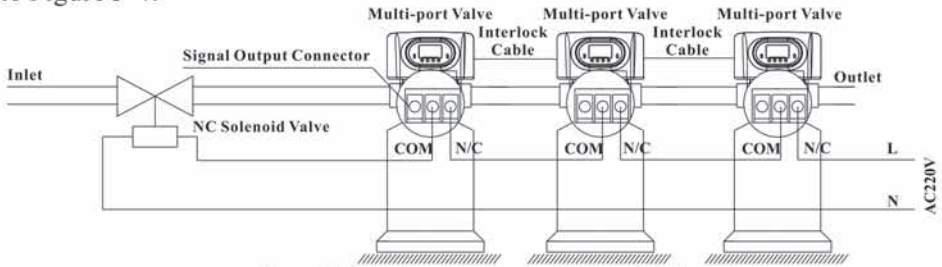

Figure 3-4 Wiring of Solenoid Valve on Inlet

2). Liquid Level Controller Controls Inlet Pump(Two-phase motor)(Set b-01)

Instruction: For the system using ground water or middle-tank supplying water, users can turn on and turn off the pump by operating the switch of liquid level controller and valve. The wiring refers to Figure 3-5:

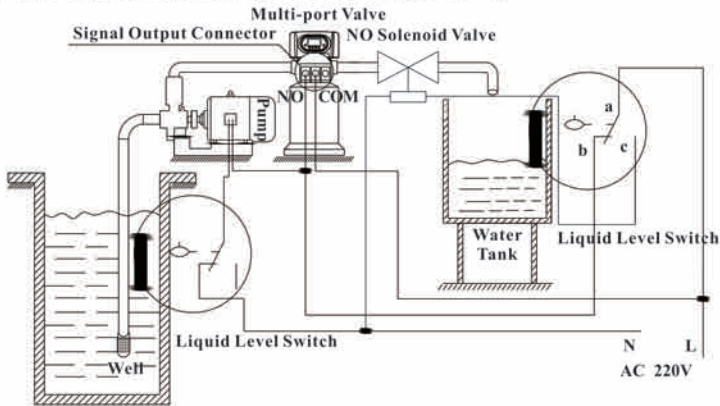

Figure 3-5 Wiring of Liquid Level Controller Controlling Inlet Pump

Function:

When valve is in service status, if water tank is short of water, pump starts working, but if water tank has enough water, the switch of liquid level controller is closed, so pump doesn't work.

When valve in regeneration cycle, inlet always has water no matter what is water condition in water tank. As Runin valve, no water passes outlet in regeneration cycle,

it ensures no water fill into brine tank. A liquid switch at the top opening well or in middle water tank in RO system protects pump from working without water in case of out of raw water.

3).Liquid Level Switch in Water Tank Controls Inlet Pump (Three-phase,Figure 3-6) (Set b-01)

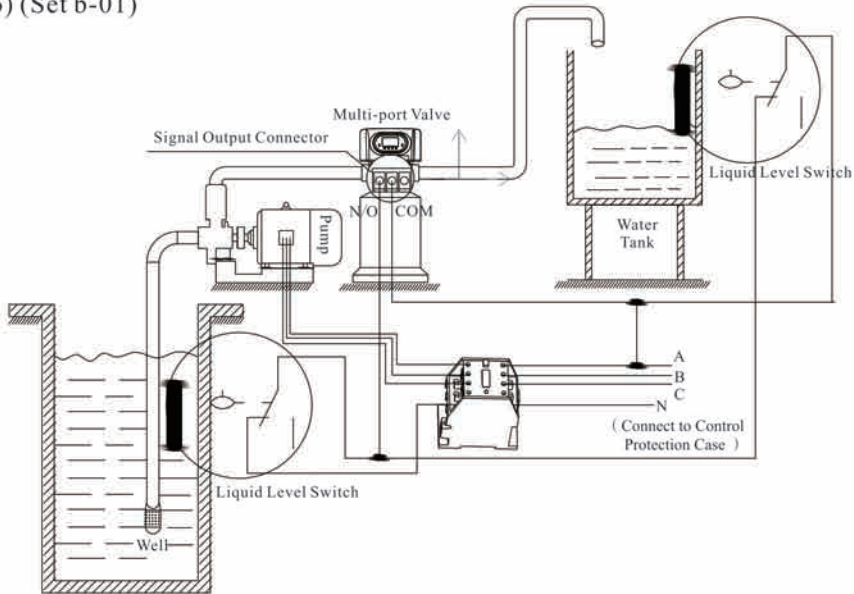

Figure 3-6 Wiring of Liquid Level Controller Controlling 380V Inlet Pump

4).Control Inlet Booster Pump(Set b-01 or b-02)

Instruction: If inlet water pressure is less than 0.15 MPa, which makes backwash or rinse draw difficult, a booster pump is suggested to be installed on inlet. Set control mode as b-01. When system in regeneration cycle, booster pump is open, the wiring refers to Figure 3-7.If the booster pump current is bigger than 5A, system needs to install a contactor, the wiring refers to Figure 3-8.

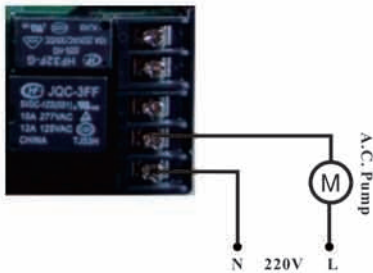

Figure 3-7 Wiring of Booster Pump on Inlet

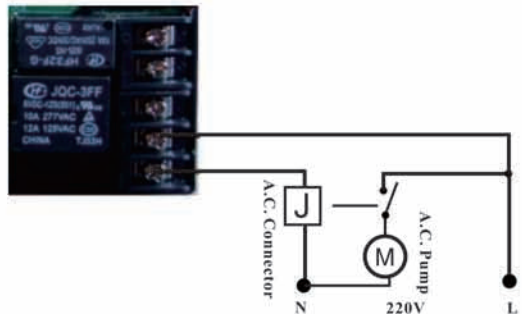

Figure 3-8 Wiring of Booster Pump on Inlet

B. Interlock

Instruction: In the parallel water treatment system, it ensures only one valve in regeneration or washing cycle and (n-1) valves in service, that is, realizing the function of supplying water simultaneously and regenerating individually.

In the series water treatment system which is suited for RO pretreatment system or second grade Na⁺ system, it ensures only one valve in regeneration or washing cycle and every grade has water when in regeneration or washing. Wiring refers to Figure 3-9.

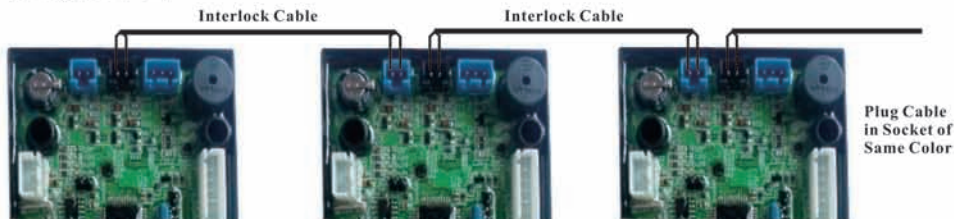

Figure 3-9 Network System Wiring with Interlock Cable

Use interlock cable to connect CN8 to CN7 on next valve in the loop.

One system with several valves, if interlock cable is disconnected, the system is divided into two individual systems.

C. Pressure Relief Output

Runxin valve will cut off feeding water to drain line when it switches in regeneration cycles. Thus in some water treatment systems, e.g. Deep Well, one booster pump was installed on the inlet to increase the system water feeding pressure, this cut-off will cause pressure on inlet rising so fast to damage the valve. Pressure Relief Output can be used to avoid this problem. The wiring refers to Figure 3-10.

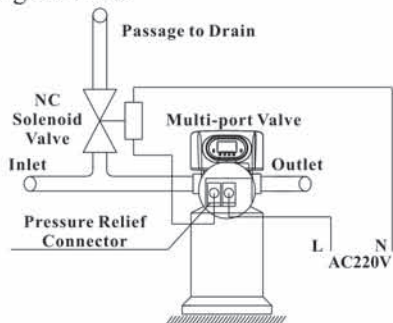

Figure 3-10 Wiring of Pressure Relief Output



Figure 3-11 Wiring of Remote Input

D. Remote Handling Connector

When the valve is used to make pure water or other system that can be monitored

online or connected to a PC, etc., when the conductivity or other parameters reach the set value or the PC sends a signal and needs system regeneration, it can provide a signal to remote handling connector of main control board by the signal line, which can make the valve regenerate immediately. The connector receiving the signal is equivalent to pressing the manual button..

E. Interlock System

2 or more than 2 valves are interlocked connecting in one system and all valves are in service but regenerate individually. The wiring refers to Figure 3-12.

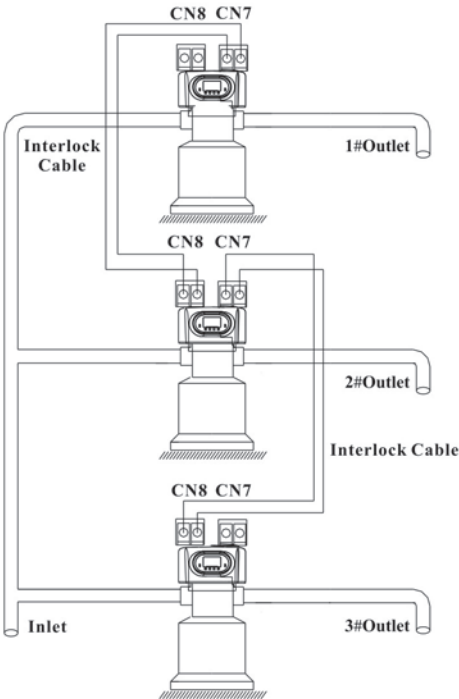

Figure 3-12 Interlock System

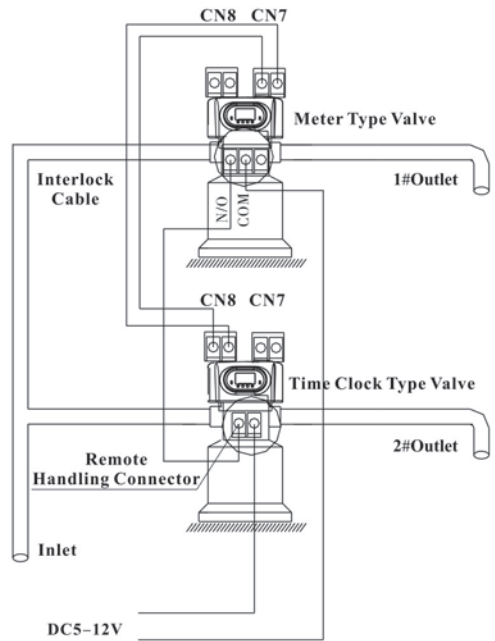

Figure 3-13 Series System

F. Series System

This is 2 or more than 2 valve systems, all in service, with one flow meter for the entire system. For the time type valve, the regeneration time should be set and adjusted to the Max; for the meter type valve, connect its signal output connector with the remote handle connector of the time type valve. That can realize the function of supplying water simultaneously and regenerating orderly. The wiring refers to Figure 3-13.

3.3. System Configuration and Flow Rate Curve

A. Product Configuration

①. 63515/63615/73715/73615 softener valve configuration with tank, resin volume, brine tank and injector.

Tank Size (mm)	Resin Volume (L)	Flow Rate (t/h)	Brine Tank Size (mm)	The Minimum Salt Consumption for Regeneration(Kg)	Injector Model
φ750×1800	450	11.0	φ840×1335	67.50	7702
φ900×2400	900	16.0	φ1080×1460	135.00	7703
φ1000×2400	1100	20.0	φ1240×1575	165.00	7704

Attention: The flow rate calculation is based on linear velocity 25m/h; the minimum salt consumption for regeneration calculation is based on salt consumption 150g / L (Resin).

②. 51240B/53540B/53604B filter valve configuration with tank and filter volume.

Tank Size	Filter Volume	A/C Filter		Sand Filter	
		Filter Flow Rate	Backwash Flow Rate	Filter Flow Rate	Backwash Flow Rate
mm	L	m ³ /h	m ³ /h	m ³ /h	m ³ /h
φ 500 × 1800	200	2.4	7	4.9	10.6
φ 600 × 1800	300	3.4	10	7	15.2
φ 750 × 1800	450	5.3	15.9	11	23.8

Attention: The flow rate of A/C filter calculation is based on linear velocity 12m/h, backwash flow rate calculation is based on backwash intensity 10L/(m²*s); The flow rate of sand filter calculation is based on linear velocity 25m/h, backwash flow rate calculation is based on backwash intensity 15/(m²*s).

B. Flow Rate Characteristic

1). Pressure-flow Rate Curve

Softener valve: 63515/63615/73515/73615

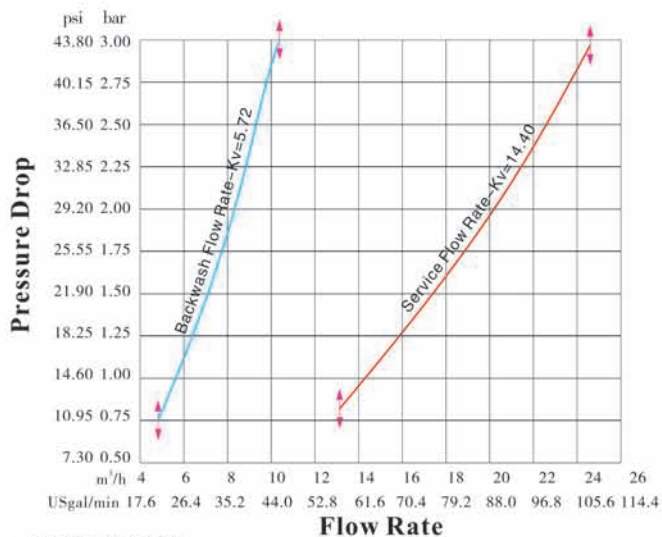

Filter valve: 53515/53615

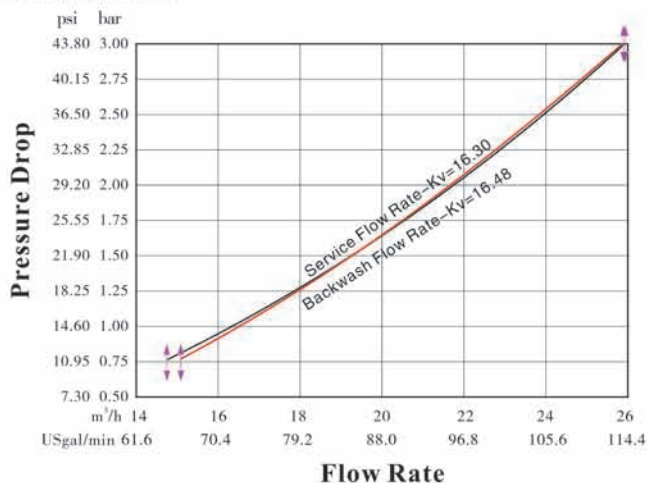

2). Injector Parameter Table

Inlet Pressure	Draw Rate (L/M)		
	7702 Pink	7703 Yellow	7704 Blue
0.20	29.20	31.50	41.10
0.25	35.16	39.50	47.16
0.30	40.65	44.00	53.64
0.35	44.84	50.50	57.88
0.40	48.70	53.50	65.48

3). Configuration for Standard Injector and Drain Line Flow Control

Tank Dia. mm	Injector Model	Injector Color	Draw Rate	Slow Rinse	Brine Refill Flow Rate	DLFC Holes Quantity & Dia	Backwash / Fast Rinse
			L/m	L/m	L/m		t/h
750	7702	Pink	40.65	24.58	102	0	8
900	7703	Yellow	44.00	28.00	112	2×φ6	10
1000	7704	Blue	53.64	34.51	110	4×φ6	12

Remark:

- Above data for the product configuration and relevant characteristics are only for reference. When put in practice, please subject to the different requirements of raw water hardness and application.
- Above parameter is tested under 0.3MPa inlet pressure.
- Holes quantity is the holes number on DLFC. Diameter of hole is φ6, the number refers to above table.
- Injectors 7702, 7703, 7704, correspond to material numbers 5468018, 5468019, 5468020.
- 73515/73615 only can match with injector 7702 and 7703. 63515/63615 could match with injector 7702, 7703 and 7704.

3.4. Parameter settlement

Parameter Settlement

① Service time T1

Water treatment capacity :

$$Q = V_r \times K \div Y_d (m^3)$$

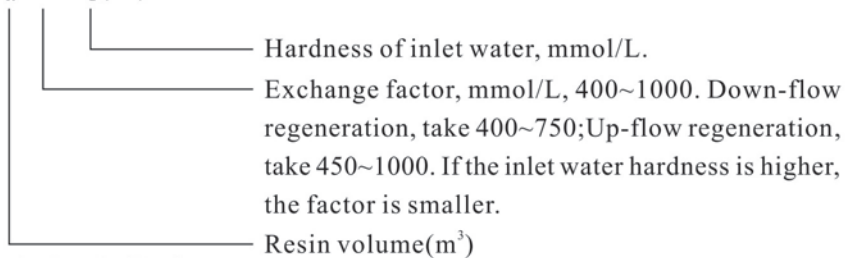

By days: $T1 = Q \div Q_d (\text{Day})$

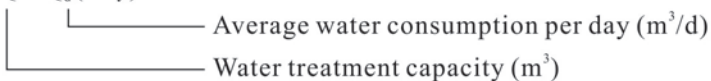

② Backwash time T2

Generally, it is suggested to be set 10~15 minutes. The higher the turbidity is, the longer backwash time shall be set. However, if the turbidity is more than 5FTU, it is better to install a filter in front of the exchanger.

③ Brine & slow rinse time T3

$$T3=(40\sim50)\times H_R \text{ (min.)}$$

$$\text{Generally, } T3=45H_R \text{ (min.)}$$

In this formula, H_R ——The height of resin in exchange tank (m.)

④ Brine refill time T4

$$\text{Down-flow regeneration: } T4 = 0.45 \times V_R \div \text{Brine refill speed (min.)}$$

$$\text{Up-flow regeneration: } T4=0.34 \times V_R \div \text{Brine refill speed (min.)}$$

In this formula, V_R —— Resin volume (m^3)

The Brine refill speed is related to inlet water pressure. It is suggested to lengthen 1~2 minutes of calculated brine refilling time to make sure there is enough water in tank. (The condition is that there is a level controller installed in the brine tank)

⑤ Fast rinse time T5

$$T5=12 \times H_R \text{ (min.)}$$

Generally, the water for fast rinse is 3~6 times of resin volume. It is suggested to be set 10~16 minutes, But it should meet the requirements of qualified outlet water.

⑥ Exchange factor

$$\text{Exchange factor} = E / (k \times 1000)$$

In this formula, E——Resin working exchange capability (mol/m^3), it is related to the quality of resin. Down-flow regeneration, take 800~900. Up-flow regeneration, take 900~1200.









K——Security factor, always take 1.2~2. it is related to the hardness of inlet water: the higher the hardness is, the bigger the K is.

⑦ Regeneration time: The whole cycle for regeneration is about two hours. Please try to set up the regeneration time when you don't need to use water according to the actual situation.

The calculation of parameters for each step is only for reference, the actual proper time will be determined after adjusting by water exchanger supplier. This calculation procedure of softener is only for industrial application; it is not suitable for small softener in residential application.

3.5. Parameter Enquiry and Setting

3.5.1. Parameter Enquiry (Take 63615 A-01 mode as a sample)

When “” lights on, press and hold both “” and “” for 5 seconds to lift the button lock status; then press “” and “” lights on, enter to program display mode; press “” or “” to view each value according to below process. (Press “” to next and turn back to service status)

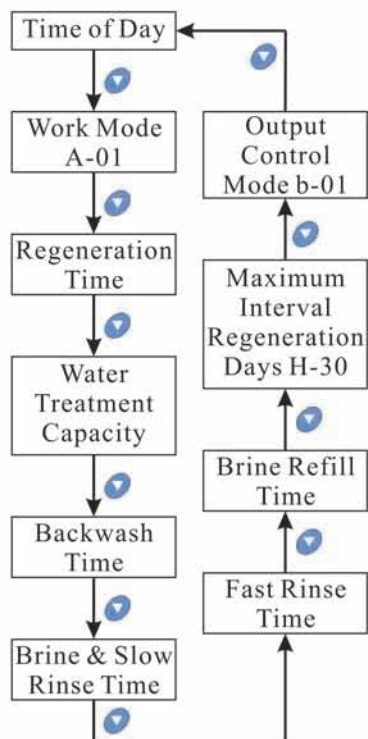

63615: Take A-01 as a sample



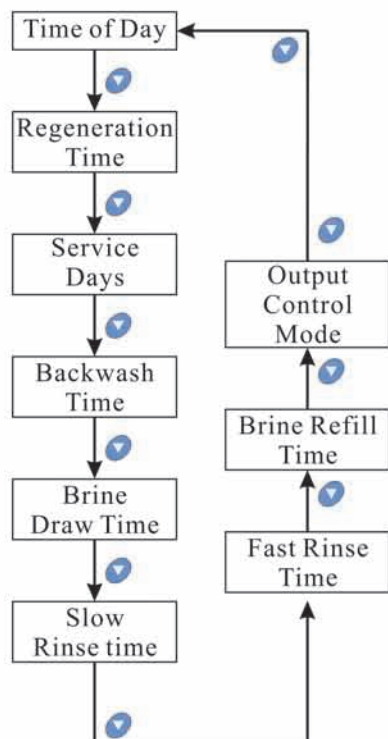









































63515:



















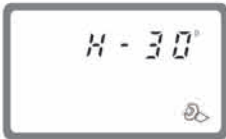

3.5.2. Parameter Setting (Take 63615 A-01 as a sample)

In program display mode, press “” and enter into program set mode. Press “” or “” to adjust the value.













3.5.3. The Steps of Parameter Setting

Items	Process Steps	Symbol
Time of Day	<p>When time of day “12:12” continuously flashes, it reminds to reset;</p> <ol style="list-style-type: none"> 1. Press “” to enter into program display mode; both “” and “” symbol light on, “:” flashes; Press “”, both “” and hour value flash, through “” or “” to adjust the hour value; 2. Press “” again, both “” and minute value flash, through “” or “” to adjust the minute value; 3. Press “” and hear a sound “Di”, then finish adjustment, press “” to turn back. 	
Control Mode	<ol style="list-style-type: none"> 1. In control mode display status, press “” and enter into program set mode, “” and 01 value flash; 2. Press “” or “”, set the value to be A-01, A-02, A-03 or A-04 control mode 3. Press “” and hear a sound “Di”, then finish adjustment, press “” to turn back. 	
Regeneration Time	<ol style="list-style-type: none"> 1. In regeneration time display status, press “” and enter into program set mode. “” and 02 flash; Press “” or “” to adjust the hour value; 2. Press “” again, “” and 00 flash, press “” or “” to adjust the minute value; 3. Press “” and hear a sound “Di”, then finish adjustment, press “” to turn back. 	
Water Treatment Capacity	<ol style="list-style-type: none"> 1. In water treatment capacity display status, it shows “” and 200.0. Press “” and enter into program set mode. “” and 200 flash; 2. Press “” or “” to adjust the integer of water treatment capacity value; 3. Press “” and decimal part flash. Press “” or “” to adjust the decimal of water treatment capacity value; 4. Press “” to finish adjustment, press “” to turn back. 	

Backwash Time	<ol style="list-style-type: none"> 1. In backwash time display status, it shows "III" and 2-10:00. Press "⏏" and enter into program set mode. "⏏" and 10 flash; 2. Press "▲" or "▼" to adjust the minutes of backwash; 3. Press "⏏" and 00 flash. Press "▲" or "▼" to adjust the seconds of backwash; 4. Press "⏏" to finish adjustment, press "⏏" to turn back. 	
Brine Draw Time	<ol style="list-style-type: none"> 1. In brine draw time display status, it shows "⏏" and 3-60:00. Press "⏏" to enter into program set mode. "⏏" and 60 flash; 2. Press "▲" or "▼" to adjust the minutes of brine; 3. Press "⏏" and 00 flashes. Press "▲" or "▼" to adjust the seconds of brine; 4. Press "⏏" to finish adjustment, press "⏏" to turn back. 	
Slow Rinse Time	<ol style="list-style-type: none"> 1. In slow rinse time display status, it shows 4-45:00. Press "⏏" to enter into program set mode. "⏏" and 45 flash; 2. Press "▲" or "▼" to adjust the minutes of brine; 3. Press "⏏" and 00 flashes. Press "▲" or "▼" to adjust the seconds of slow rinse; 4. Press "⏏" to finish adjustment, press "⏏" to turn back. 	
Fast Rinse Time	<ol style="list-style-type: none"> 1. In fast rinse time display status, it shows "III" and 5-10:00. Press "⏏" to enter into program set mode. "⏏" and 10 flash; 2. Press "▲" or "▼" to adjust the minutes of fast rinse; 3. Press "⏏" and 00 flashes. Press "▲" or "▼" to adjust the seconds of fast rinse; 4. Press "⏏" to finish adjustment, press "⏏" to turn back. 	
Brine Refill Time	<ol style="list-style-type: none"> 1. In brine refill time display status, it shows "⏏" and 6-05:00. Press "⏏" and enter into program set mode. "⏏" and 05 flash; 2. Press "▲" or "▼" to modify the minutes of brine refill; 3. Press "⏏" and 00 flashes. Press "▲" or "▼" to adjust the seconds of brine refill; 4. Press "⏏" to finish adjustment, press "⏏" to turn back. 	



<p>Maximum Interval Regeneration Days</p>	<p>1. In maximum interval regeneration days display status, it shows H-30. Press “” and enter into program set mode. “” and 30 flash; 2. Press “” or “” to adjust the interval regeneration days; 3. Press “” to finish adjustment, press “” to turn back.</p>	
<p>Signal Output Mode</p>	<p>1. In signal output mode display status, it shows b-01. Press “” and enter into program set mode. “” and 01 flash; 2. Press “” or “” to adjust the mode; 3. Press “” to finish adjustment, press “” to turn back.</p>	

For example, the fast rinse time of a softener is 12 minutes. After regenerating, the chloridion in the outlet water is always higher than normal, indicating that the time is not enough for fast rinse. If you want the time to set to 15 minutes, the modification steps as follows:



- ① Press and hold both “” and “” to lift the button lock status (“” lights off);
 - ② Press “”, and “” lights on;
 - ③ Press “” or “” continuously until “” lights on. Then the digital area shows: 5-12:00;
 - ④ Press “”, “” and 12 flash;
 - ⑤ Press “” continuously until 12 changed to 15;
 - ⑥ Press “”, there is a sound “Di” and the figure stop flashing; the program back to enquiry status
 - ⑦ If you want to adjust other parameters, you can repeat the steps from ② to ⑤;
- If you don't, press “” and quit from the enquiry status, the display will show the current service status.



3.6. Trial Running



After installing the multi-functional flow control valve on the resin tank with the connected pipes, as well as setting up the relevant parameter, please conduct the trail running as follows:



- A. Close the inlet and outlet valve B & C, and turn on the bypass valve A. After cleaning the impurity in the pipe, turn off the bypass valve A. (As Figure 1-3 shows).
- B. Add calculated water to the brine tank and adjust the air check valve. Then add solid salt to the tank and dissolve the salt as much as possible.
- C. Switch on power. Press “” and turn to the Backwash position; when “”

lights on, slowly open the inlet valve B to 1/4 position, making the water flows into the resin tank; you can hear the sound of air-out from the drain pipeline. After all air is out of pipeline, then turn on inlet valve B completely and clean the impurity in the resin tank until the outlet water is clean. It will take 8~10 minutes to finish the whole process.

D. Press “”, and turn the status from Backwash to Brine & Slow Rinse; “” lights on and enter in the process of Brine & Slow Rinse. The air check valve will turn off when control valve finished brine draw then slow rinse starts to work. It is about 60~65minutes for whole process.

E. Press “”, and turn the status from Brine & Slow Rinse to Fast Rinse. “” lights on. It takes about 10~15 minutes, take out some outlet water for testing: if the water hardness reach the requirement, and the chloridion in the water is almost the same compared with the inlet water, then go to the next step.

F. Press “”, and turn the status from Fast Rinse to Brine Refill. “” lights on and it indicates the brine tank is being refilled with water to the required level. It takes about 5~6 minutes, then add solid salt to the brine tank.

G. Press “”, making the control valve return to Service Status; “” lights on and start to running.

Note:

- When the control valve enters into the regeneration status, all program can be finished automatically according to the setting time; if you want one of steps to be terminated early, you can press “”.
- If water inflows too fast, the media in tank will be damaged. When water inflows slowly, there is a sound of air emptying from drain pipeline.
- After changing resin, please empty air in the resin according to the above Step C.
- In the process of trial running, please check the water situation in all positions, and ensure there is no resin leakage.
- The time for Backwash, Brine Draw, Slow Rinse, Fast Rinse and Brine Refill status can be set and executed according to the calculation in the formula or suggested from the control valve suppliers.

3.7.Trouble-Shooting

A.Control Valve Fault

Problem	Cause	Correction
1. Softener fails to regenerate.	A. Electrical service to unit has been interrupted. B. Regeneration cycles set incorrect. C. Controller is defective. D. Motor fails to work.	A. Assure permanent electrical service (Check fuse, plug, pull chain or switch). B. Reset regeneration cycles. C. Check or replace controller. D. Check or replace motor.
2. Regeneration time is not correct.	A. Time of day does not set correctly. B. Power failure more than 3 days. the time of day does not reset, is not correct.	Check program and reset time of day.
3. Softener supply hard water.	A. Bypass valve is open or leaking. B. No salt in brine tank. C. Injector is plugged. D. Insufficient water flows into brine tank. E. Internal valve leaks. F. Incorrect regeneration time or raw water quality deterioration. G. Shortage of resin. H. Bad quality of raw water or turbine is blocked.	A. Close or repair bypass valve. B. Add salt to brine tank and maintain salt level above water level. C. Change or clean injector. D. Check brine tank refill time. E. Change valve body. F. Set correct regeneration time or water capacity treatment. G. Add resin to mineral tank and check whether resin leaks. H. Reduce the inlet turbidity, clean or replace turbine.
4. Softener fails to draw brine.	A. Inlet line pressure is too low. B. Brine line is plugged. C. Brine line is leaking. D. Injector is plugged or broken down. E. Internal valve leaks. F. Drain line is plugged. G. Sizes of injector and DLFC are not matched with tank. H. Ball valve or cable breaks down.	A. Increase inlet line pressure. B. Clean brine line. C. Replace brine line. D. Clean or replace new injector. E. Replace valve body. F. Clean drain line flow control. G. Select correct injector size and DLFC according to the instruction manual. H. Replace ball valve or cable.
5. Unit used too much salt.	A. Improper salt setting. B. Excessive water in brine tank.	A. Check salt usage and salt setting. B. See problem No.6.
6. Excessive water in brine tank.	A. Overlong refilling time. B. Remain too much water after brine. C. Foreign material in brine valve. D. Not install safety brine valve but power failure while salting. E. Brine refill is out of control. F. Ball valve doesn't close.	A. Reset correct brine refilling time. B. Check the injector and make sure no stuff in the brine pipe. C. Clean brine valve and brine line. D. Stop water supplying and restart or install safety brine valve in salt tank. E. Repair or replace safety brine valve. F. Close or replace ball valve or cable.

MODEL 53515/53615/63515/63615/73515/73615

7. Pressure lost or rust in pipeline	<p>A. Iron in the water supply pipe. B. Iron mass in the softener. C. Fouled resin bed. D. Too much iron in the raw water.</p>	<p>A. Clean the water supply pipe. B. Clean valve and add resin cleaning chemical, increase frequency of regeneration. C. Check backwash, brine draw and brine tank refill. Increase frequency of regeneration and backwash time. D. Iron removal equipment is required to install before softening.</p>
8. Loss of mineral through drain line.	<p>A. Air in water system. B. Strainer broken. C. Improperly sized drain line control.</p>	<p>A. Assure that well system has proper air eliminator control. B. Replace new strainer. C. Check for proper drain rate.</p>
9. Control cycle continuously.	<p>A. Locating signal wiring breakdown. B. Controller is faulty. C. Foreign material stuck the driving gear. D. Time of regeneration steps were set to zero.</p>	<p>A. Check and connect locating signal wiring. B. Replace controller. C. Take out foreign material. D. Check and reset program setting.</p>
10. Drain flows continuously.	<p>A. Internal valve leak. B. Power off when in backwash or fast rinse.</p>	<p>A. Check and repair valve body or replace it. B. Adjust valve to service position or turn off bypass valve and restart when electricity supply.</p>
11. Interrupted or irregular brine.	<p>A. Water pressure is too low or not stable. B. Injector is plugged or faulty. C. Air in resin tank. D. Floccules in resin tank during up-flow regeneration.</p>	<p>A. Increase water pressure. B. Clean or replace injector. C. Check and find the reason. D. Clean the floccules in resin tank.</p>
12. Water flows out from drain or brine pipe after regeneration.	<p>A. Foreign material in valve which makes valve can't be closed completely. B. Hard water mixed in valve body. C. Water pressure is too high which results in valve not getting the right status. D. Ball valve doesn't shut-off completely.</p>	<p>A. Clean foreign material in valve body. B. Change valve core or sealing ring. C. Reduce water pressure or use pressure relief function. D. Repair or replace ball valve.</p>
13. Salt water in outflow pipeline	<p>A. Foreign material in injector or injector fails to work. B. Brine valve cannot be shut-off. C. Time of fast rinse is too short.</p>	<p>A. Clean and repair injector. B. Repair brine valve and clean it. C. Extend fast rinse time.</p>
14. Unit capacity decreases.	<p>A. Regenerate not properly. B. Fouled resin bed. C. Salt setting is not proper. D. Softener setting is not proper. E. Raw water quality deteriorated. F. Turbine of flow meter has already gotten stuck.</p>	<p>A. Regenerate according to the correct operation requirement. B. Increase backwash flow rate and time, clean or change resin. C. Readjust brine drawing time. D. According to the test of outlet water, recount and reset. E. Regenerate unit by manual temporary then reset regeneration cycle. F. Disassemble flow meter and clean it or replace a new flow meter.</p>

B.Controller Fault

Problem	Cause	Correction
1. All indicators display on front panel.	A. Wiring of display board with control board fails to work. B. Control board is faulty. C. Transformer is damaged. D. Electrical service is not stable. E. Display board is faulty.	A. Check and replace the wiring. B. Replace control board. C. Check and replace transformer. D. Check and adjust electrical service. E. Replace display board.
2. No display on front panel	A. Wiring of display board with control board fails to work. B. Display board is damaged. C. Control board is damaged. D. Adapter is damaged.	A. Check and replace wiring. B. Replace display board. C. Replace control board. D. Replace adapter.
3. E1 Flashes	A. Wiring of locating board with control board fails to work. B. Locating board damaged. C. Mechanical driven failure. D. Faulty control board. E. Wiring of motor with control board is fault. F. Motor is damaged.	A. Replace wiring. B. Replace locating board. C. Check and repair mechanical part. D. Replace control board. E. Replace wiring. F. Replace motor.
4. E2 Flashes	A. Wiring of locating board with control board fails to work. B. Locating board is damaged. C. Control board is damaged.	A. Replace wiring. B. Replace locating board. C. Replace control board.
5.E12 or E22 Flashes	A. Hall component on locating board is damaged. B. Wiring of locating board with controller fails to work. C. Control board is damaged.	A. Replace locating board. B. Replace wiring. C. Replace control board.
6. E3 or E4 Flashes	A. Control board is faulty.	A. Replace control board.

3.8.Assembly & Parts

Construction figure of 53615

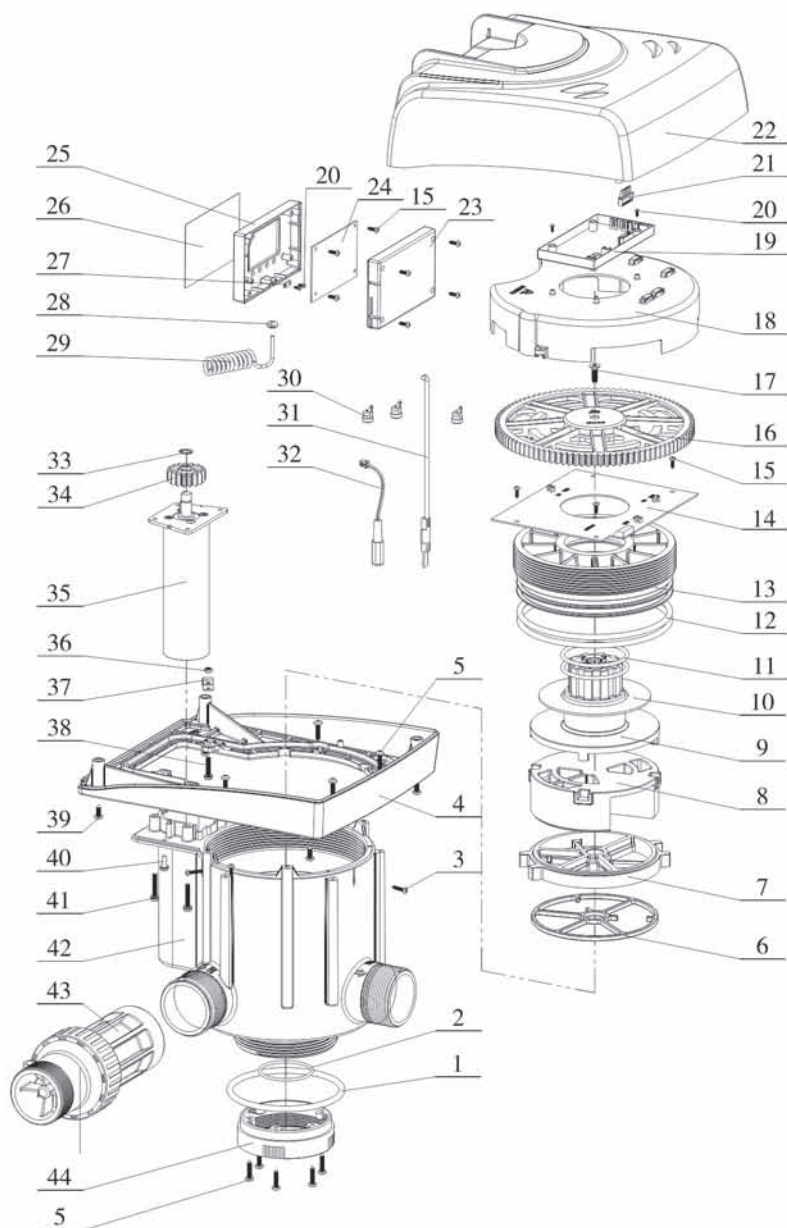

MODEL 53515/53615/63515/63615/73515/73615

53615 Valve Body Components and Part No.:

Item No.	Description	Part No.	Quantity	Item No.	Description	Part No.	Quantity
1	O-ring 104.6x5.7	8378146	1	23	Cover	8315016	1
2	O-ring 48.9x2.62	8378071	1	24	Display Board	6381003	1
3	Screw, Cross ST3x16	8909010	3	25	Front Cover	8300025	1
4	Junction Plate	8152031	1	26	Sticker	8865023	1
5	Screw, Cross ST3.9x19	8909003	9	27	Cable Clip	8126001	1
6	Seal Ring	8370129	1	28	Bushings	8126006	1
7	Fixed Disk	8469098	1	29	Three-core Spring	5517003	1
8	Moving Disk	8459096	1	30	Toggle	8126004	3
9	Shaft	8258037	1	31	Flow Meter Sensor	6386003	1
10	Anti-friction Washer	8216028	1	32	Wire for Power	5513001	1
11	O-ring 59.92x3.53	8378110	2	33	Locking Ring	8994009	1
12	O-ring 142.24x5.33	8378245	2	34	Small Gear	8241008	1
13	Pressure Nut	8092043	1	35	Motor	6158038	1
14	Locating Board	6380057	1	36	Hexagonal Nut	8940002	3
15	Screw, Cross ST3x10	8909008	14	37	Cable Clip	8126002	1
16	Gear	8241040	1	38	Screw, Cross Set M4x20	8902007	1
17	Screw, Cross ST5x20	8909018	1	39	Screw, Cross Set ST4x12	8909013	4
18	Fixed Base	8109079	1	40	Screw, Cross Set M4x12	8902005	1
19	Control Board	6382091	1	41	Screw, Cross Set M4x25	8902008	4
20	Screw, Cross ST2.2x6.5	8909004	4	42	Valve Body	5022139	1
21	Wire for Locating Board	5511023	1	43	Flow Meter	5447003	1
22	Dust Cover	5005057	1	44	Connector	8458018	1

Note: Compared with 53615, there are no item no.31 and item no.43 for 53515.

Construction figure of 63615

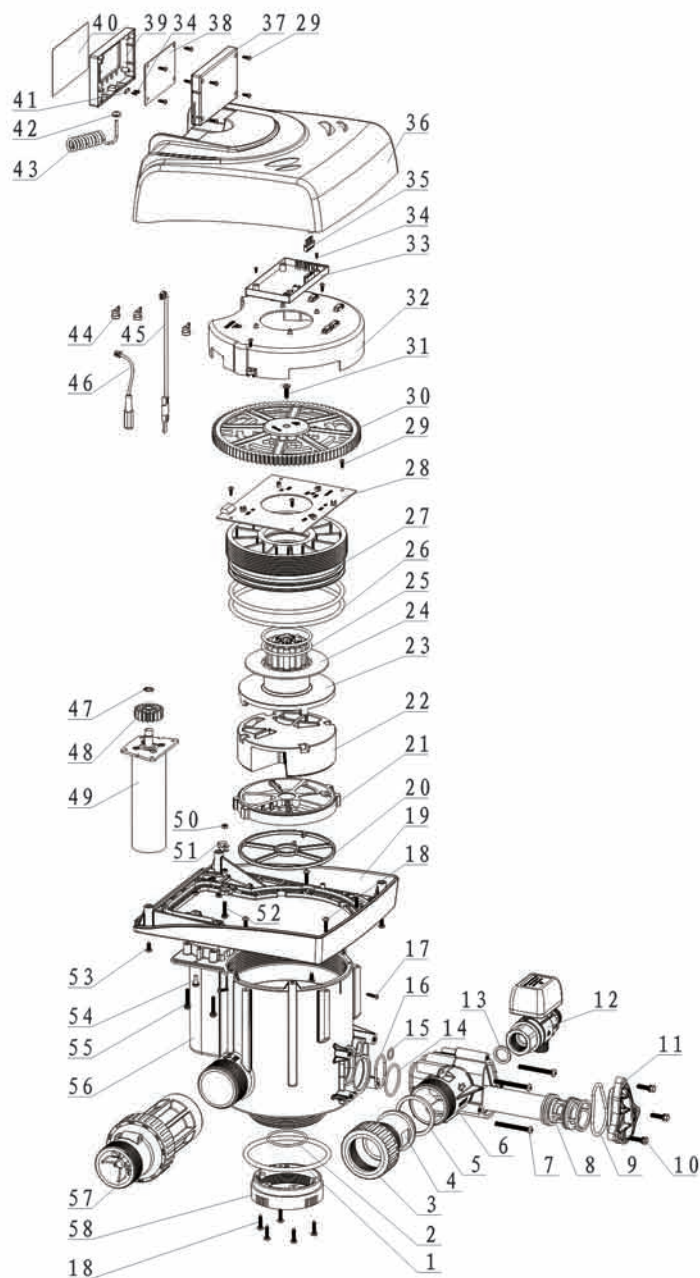

MODEL 53515/53615/63515/63615/73515/73615

63615 Valve Body Components and Part No.:

Item No.	Description	Part No.	Quantity	Item No.	Description	Part No.	Quantity
1	O-ring 104.6×5.7	8378146	1	30	Gear	8241040	1
2	O-ring 48.9×2.62	8378071	1	31	Screw, Cross St5×20	8909018	1
3	Animated Connector	8947005	1	32	Fixed Base	8109079	1
4	Brine Line Flow Control	8468013	1	33	Control Board	6382091	1
5	Seal Ring	8371008	1	34	Screw, Cross ST2.2×6.5	8909004	4
6	Injector Body	5008001	1	35	Wire for Locating Board	5511023	1
7	Screw, Cross M5×50	8902062	4	36	Dust Cover	5005057	1
8	Injector	5468019	1	37	Cover	8315016	1
9	O-ring 50×3.55	8378205	1	38	Display Board	6381003	1
10	Hexagonal Bolt Set M5×20	5851006	3	39	Front Cover	8300025	1
11	Injector Cover	8315060	1	40	Sticker	8865023	1
12	Electronic Ball Valve	6922075	1	41	Cable Clip	8126001	1
13	Seal Ring	8371019	1	42	Bushings	8126006	1
14	O-ring 38.7×2.65	8378243	1	43	Three-core Spring	5517003	1
15	O-ring 12.5×1.8	8378244	1	44	Toggle	8126004	3
16	O-ring 34.5×2.65	8378242	1	45	Flow Meter Sensor	6386003	1
17	Screw, Cross St3×16	8909010	3	46	Wire for power	5513001	1
18	Screw, Cross ST3.9×19	8909003	9	47	Locking Ring	8994009	1
19	Junction Plate	8152031	1	48	Small Gear	8241008	1
20	Seal Ring	8370099	1	49	Motor	6158038	1
21	Fixed Disk	8469063	1	50	Hexagonal Nut	8940002	3
22	Moving Disk	8459063	1	51	Cable Clip	8126002	1
23	Shaft	8258037	1	52	Screw, Cross Set M4×20	8902007	1
24	Anti-friction Washer	8216028	1	53	Screw, Cross Set St4×12	8909013	4
25	O-ring 59.92×3.53	8378110	2	54	Screw, Cross Set M4×12	8902005	1
26	O-ring 142.24×5.33	8378245	2	55	Screw, Cross Set M4×25	8902008	4
27	Pressure Nut	8092043	1	56	Valve Body	5022084	1
28	Locating Board	6380040	1	57	Flow Meter	5447003	1
29	Screw, Cross St3×10	8909008	14	58	Connector	8458018	1

Note: Compared with 63615, there are no item no.45 and item no.57 for 63515

Construction figure of 73615

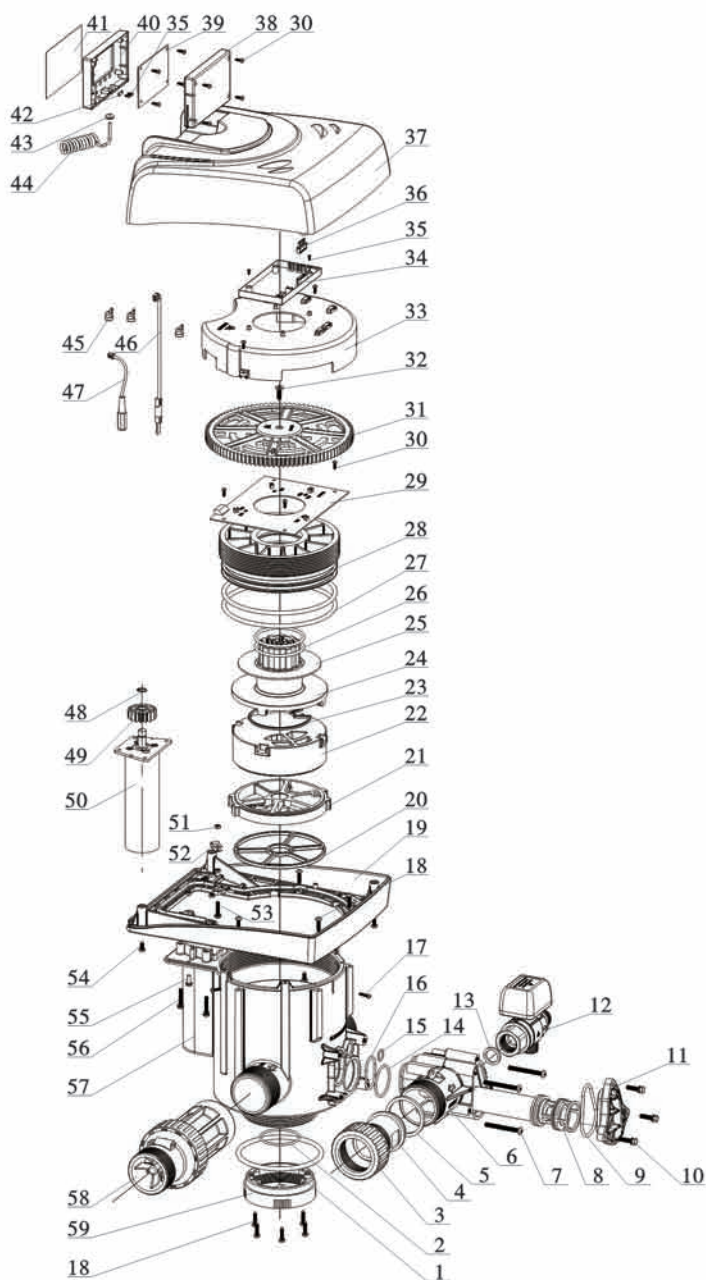

MODEL 53515/53615/63515/63615/73515/73615

73615 Valve Body Components and Part No.:

Item No.	Description	Part No.	Quantity
1	O-ring 104.6×5.7	8378146	1
2	O-ring 48.9×2.62	8378071	1
3	Animated Connector	8947005	1
4	Brine Line Flow Control	8468013	1
5	Seal Ring	8371008	1
6	Injector Body	5008001	1
7	Screw, Cross M5×50	8902062	4
8	Injector	5468019	1
9	O-ring 50×3.55	8378205	1
10	Hexagonal Bolt Set M5×20	5851006	3
11	Injector Cover	8315060	1
12	Electronic Ball Valve	6922075	1
13	Seal Ring	8371019	1
14	O-ring 38.7×2.65	8378243	1
15	O-ring 12.5×1.8	8378244	1
16	O-ring 34.5×2.65	8378242	1
17	Screw, Cross ST3×16	8909010	3
18	Screw, Cross ST3.9×19	8909003	9
19	Junction Plate	8152031	1
20	Seal Ring	8370103	1
21	Fixed Disk	8469070	1
22	Moving Disk	8459069	1
23	Moving Seal Ring	8370018	1
24	Shaft	8258037	1
25	Anti-friction Washer	8216028	1
26	O-ring 59.92×3.53	8378110	2
27	O-ring 142.24×5.33	8378245	2
28	Pressure Nut	8092043	1
29	Locating Board	6380042	1
30	Screw, Cross St3×10	8909008	14

Item No.	Description	Part No.	Quantity
31	Gear	8241040	1
32	Screw, Cross St5×20	8909018	1
33	Fixed Base	8109079	1
34	Control Board	6382091	1
35	Screw, Cross ST2.2×6.5	8909004	4
36	Wire for Locating Board	5511023	1
37	Dust Cover	5005057	1
38	Cover	8315016	1
39	Display Board	6381003	1
40	Front Cover	8300025	1
41	Sticker	8865023	1
42	Cable Clip	8126001	1
43	Bushings	8126006	1
44	Three-core Spring	5517003	1
45	Toggle	8126004	3
46	Flow Meter Sensor	6386003	1
47	Wire for Power	5513001	1
48	Locking Ring	8994009	1
49	Small Gear	8241008	1
50	Motor	6158038	1
51	Hexagonal Nut	8940002	3
52	Cable Clip	8126002	1
53	Screw, Cross Set M4×20	8902007	1
54	Screw, Cross Set St4×12	8909013	4
55	Screw, Cross Set M4×12	8902005	1
56	Screw, Cross Set M4×25	8902008	4
57	Valve Body	5022098	1
58	Flow Meter	5447003	1
59	Connector	8458018	1

Note: Compared with 73615, there are no item no.46 and item no.58 for 73515

5447003 Flow meter structure:

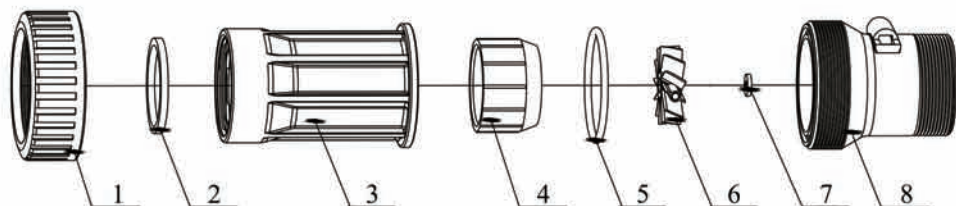

5447003 Flow Meter Components and Part No.:

Item No.	Description	Part No.	Quantity
1	Animated Connector	8947004	1
2	Seal Ring	8371008	1
3	Connector	8458016	1
4	Fixed Connector	8109006	1
5	O-ring 60×4	8378137	1
6	Turbine	5436005	1
7	Bush	8210002	1
8	Flow Meter Shell	5002002	1

5458002 Side-mounted connector structure:

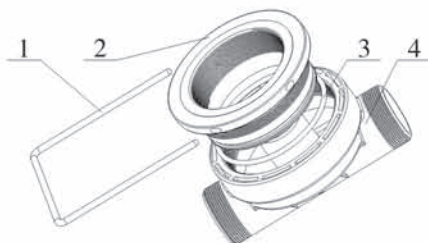

5458002 Side-mounted Connector Components and Part No.:

Item No.	Description	Part No.	Quantity	Item No.	Description	Part No.	Quantity
1	Steel Fork	8271003	1	3	O-ring	8378140	1
2	Joint	8457017	1	4	Connector	8458037	1

4. Warranty Card

Dear client:

This warranty card is the guarantee proof of RUNXIN brand multi-functional flow control valve. It is kept by client self. You could get the after-sales services from the supplier which is appointed by RUNXIN manufacturer. Please keep it properly. It couldn't be retrieved if lost. It couldn't be repaired free of charge under the below conditions:

1. Guarantee period expired. (One year)
2. Damage resulting from using, maintenance, and keeping that are not in accordance with the instruction.
3. Damage resulting from repairing not by the appointed maintenance personnel.
4. Content in guarantee proof is unconfirmed with the label on the real good or be altered.
5. Damage resulting from force majeure.

Product Name	Multi-functional Flow Control Valve for Water Treatment Systems			
Model		Code of Valve Body		
Purchase Company Name		Tel/Cel.		
Problem				
Solution				
Date of Repairing		Date of Examination		Maintenance Man Signature

When product needs warranty service, please fill in the below content and send this card together with the product to the appointed suppliers or Runxin company.

End-user Company Name		Tel/Cel.	
Purchase Company Name		Tel/Cel.	
Model	Code of Valve Body		
Tank Size ϕ ×	Resin Tank Size L	Raw Water Hardness mmol/L	
Water Source: Ground-water <input type="checkbox"/> Tap Water <input type="checkbox"/>	Water Treatment Capacity m³	Backwash Time min	
Brine Draw Time min	Slow Rinse Time min	Brine Refill Time min	Fast Rinse Time min
Problem Description			



WENZHOU RUNXIN MANUFACTURING MACHINE CO.,LTD

ADD: NO.169, RUNXIN ROAD, SHANFU TOWN, WENZHOU, ZHEJIANG, CHINA.

TEL.:0086-577-88630038, 88576512, 85956057 FAX:0086-577-88633258

E-MAIL: sales@run-xin.com <http://www.run-xin.com>