



Multi-functional Flow Control Valve for Water Treatment Systems

73605 (Old Model No.:F92A3)
73605B (Old Model No.:F92B3)
73505 (Old Model No.:F92A1)
73505B (Old Model No.:F92B1)
63605E (Old Model No.:F130A3)
63605F (Old Model No.:F130B3)
63505E (Old Model No.:F130A1)
63505F (Old Model No.:F130B1)

User Manual

Please read this manual in details
before using this valve and keep it properly
in order to consult in the future

0WRX.466.543



Before the valve put into use, please fill in the below content so as to help us to refer in the future.

Softener System Configuration

Tank Size: Dia. _____mm, Height_____mm;

Resin Volume _____L; Brine Tank Capacity_____L;

Hardness of Raw Water_____mmol/L;

Pressure of Inlet Water_____MPa;

Control Valve Model_____ ; Number_____ ;

The Specification of Brine Line Flow Control_____;

Injector No._____.

Water Source: Ground-water Filtered Ground-water Tap Water Other_____.

Parameter Set

Parameter	Unit	Factory Default	Actual Value
On-line Program	/	C-01(Interlock Program)	
Data Clear	/	d-01 (Close)	
Control Mode A-01/02/03/04/05/06	/	A-01	
Water Treatment Capacity(A-01/02/05)	m ³	50.00m ³	
Flow Rate Unit	m ³	m ³	
Regeneration Time(A-01/03/05/06)	/	02 : 00	
Service Days(A-06)	D.	03	
Regeneration Factor(A-03/04)	/	0.65	
Resin Volume (A-03/04)	L.	20	
Raw Water Hardness(A-03/04)	mmol/L	1.2	
Interval Backwash Times (only suited for 73605)	/	F-00	
Backwash Time	min:sec	10:00	
Brine & Slow Rinse Time	min:sec	60:00	
Fast Rinse Time	min:sec	10:00	
Brine Refill Time	min:sec	05:00	
Maximum Interval Regeneration Days	D.	30	
Output Mode b-01(02)	/	b-01	

● If there is no special requirement when product purchase, we choose 8468062 drain line flow control and 8468055 brine line flow control, 6309 injector for the standard configuration.

Catalogue

Notice.....	3
1. Product Overview.....	4
1.1. Main Application & Applicability.....	4
1.2. Product Characteristics.....	4
1.3. Service Condition.....	6
1.4. Product Structure and Technical Parameters.....	7
1.5. Installation.....	8
2. Basic Setting & Usage.....	10
2.1. The Function of PC Board.....	10
2.2. Basic Setting & Usage.....	11
3. Application.....	15
3.1. Softener Flow Chart.....	15
3.2. The Function and Connection of PC Board.....	15
A. Signal Output Connector.....	16
B. Interlock.....	19
C. One in Service One Standby.....	20
D. Remote Handling Connector.....	20
E. Interlock System.....	21
F. Series System.....	21
3.3. System Configuration and Flow Rate Curve.....	22
3.4. Parameter Settlement.....	24
3.5. Parameter Enquiry and Setting.....	25
3.6. Trial Running.....	30
3.7. Trouble-Shooting.....	31
3.8. Spare Part and Part No.....	35
4. Warranty Card.....	41

Notice

- To ensure normal operation of the valve, please consult with professional installation or repairing personnel before use it.
- If there are any of pipeline engineering and electric works, there must be finished by professional at the time of installation.
- Do not use the control valve with the water that is unsafe or unknown quality.
- Depending on the changing of working environment and water requirement, each parameter of softener should be adjusted accordingly.
- When the water treatment capacity is too low, please check the resin. If the reason is shortage of resin, please add; if the resin is turn to reddish brown or broken, please replace.
- Test water periodically to verify that system is performing satisfactorily.
- Sodium used in the water softening process should be considered as part your overall dietary salt intake. Contact doctor if you are on a low sodium diet.
- Ensure that there is solid salt all the time in the brine tank in the course of using, when this valve is used for softening. The brine tank should be added the crystalline coarse salt only, at least 99.5% pure, forbidding use the small salt.
- Do not put the valve near the hot resource, high humidity, corrosive, intense magnetic field or intense librations environment. And do not leave it outside.
- Forbidden to carry the injector body. Avoid using injector body as support to carry the system.
- Forbidden to use the brine tube or other connectors as support to carry the system.
- Please use this product under the water temperature between 5~50 °C, water pressure 0.15~0.6MPa. Failure to use this product under such conditions voids the warranty.
- If the water pressure exceeds 0.6Mpa, a pressure reducing valve must be installed before the water inlet. While, if the water pressure under 0.15MPa, a booster pump must be installed before the water inlet.
- PPR pipes, corrugated pipes or UPVC pipe are recommended for pipe installation and aluminum-plastic pipes should be avoided.
- Do not let children touch or play, because careless operation may cause the procedure changed.
- When the attached cables or transformer of this product are broken, they must be changed to the one that is from our factory.

1.Product Overview

1.1.Main Application & Applicability

Used for softening or demineralization water treatment systems.

Be suitable for

- Residential softening system
- Ion exchange equipment
- Boiler softening water system
- RO pretreatment softening system, etc.

1.2.Product Characteristics

●Simple structure and reliable sealing

It adopts hermetic head faces with high degree pottery and corrosion resistance for opening and closing. It combines with Service, Backwash, Brine & Slow Rinse, Brine Refill and Fast Rinse.

●Up-flow Regeneration (It is suited for F92)

Up-flow regeneration, save salt and water, has better regeneration efficiency.

●Soft Water Refill (It is suited for F92)

System is also in service when in brine tank refill (Means soft water flows in outlet), save the regeneration time and regenerate more efficient.

●Large Water Treatment Capacity

Flow rate will be more than $4.7\text{m}^3/\text{h}$ when pressure drop is 0.1MPa .

●Historical Record can be Enquired

Users can enquiry maximum flow rate of previous 7 days, regeneration times after being used and all data records can be cleared.



●Manual function

Realize regeneration immediately by pressing  at any time.

●Long outage indicator

If outage overrides 3days, the time of day indicator 12:12 will flash to remind people to reset new time of day. The other set parameters do not need to reset. The process will continue to work after power on.

●Buttons lock

No operations to buttons on the controller within 1 minute, button lock indicator lights on which represents buttons are locked. Before operation press and hold the  and  buttons for 5 seconds to unlock. This function can avoid incorrect operation.

●Technician or manufacturers can choose regeneration control mode via getting authority.



When control valve get connected with power, press button ,  and  in turn to enter into enquiry and set menu which is available for technician or manufacture. Six control modes listed in table 1 can be chose in regeneration control mode menu.

Table 1

Mode	Name	Instruction
A-01	Meter Delayed	Regenerate on the day although the available volume of treated water drops to zero (0). Regeneration starts at the regeneration time.
A-02	Meter Immediate	Regenerate immediately when the available volume of treated water drops to zero(0).
A-03	Intelligent Meter Delayed	Meter Delayed Regeneration type, but by setting Resin Volume, Raw Water Hardness, the controller will calculate the System Capacity. Regeneration mode is same as A-01.
A-04	Intelligent Meter Immediate	Meter Immediately Regeneration Type, but by setting Resin Volume, Raw Water Hardness, the controller will calculate the System Capacity. Regeneration mode is same as A-02.
A-05	Surplus Water Comparing	When the available volume of treated water is lower than average day water capacity of previous 7 days, regeneration starts at the regeneration time.
A-06	Time Type by Day	Service days count down to zero(0), regeneration stars at the regeneration time.

●Signal output

There is a signal output connector on main control board. It is for controlling external wiring. (Refer to Figure7 to Figure 13).

There are two kinds of output modes: b-01 Mode: the signal will turn on at the beginning of regeneration and turn off at the end of regeneration; b-02 Mode: Signal available only intervals of each status (Motor running moment). Refer to below figure:

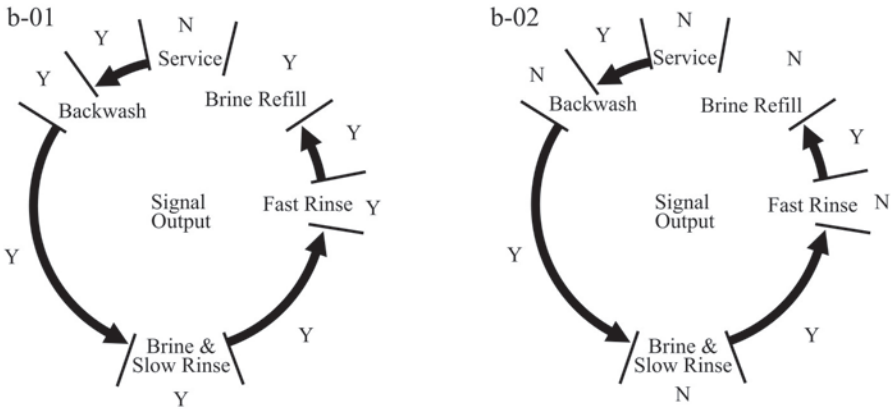

●Interlock function

Set program function of “Interlock C-01” to realize only one valve in regeneration but the other valves are in service while several valves parallel or series connection in system. (Application refer to Figure 14)

One in service one standby

Set program function of “One in service one standby” to realize continuously water supply while the outlet of two valves connected with Runxin specialized three-way ball valve, it can realize continuous water supplying, and this is called one in service one standby. (Application refer to Figure 15)

Remote handling connector

This connector can receive 5~24VDC external signal, used together with PLC, and computer etc. to control the valve remotely. (Application refer to Figure 16)

Maximum interval regeneration days (Not available for A-06)

Under the situation of service reaching the setting days and the volume not yet, it could enter into regeneration process forcibly when current time is the same as regeneration time.

All parameters can be modified

According to the water quality and usage, the parameters in the process can be adjusted.

1.3.Using condition

Valve should be used under the below conditions

Item		Requirement
Working conditions	Working pressure	0.15MPa ~ 0.6MPa
	Water temperature	5℃ ~ 50℃
Working environment	Environment temperature	5℃ ~ 50℃
	Relative humidity	≤95% (25℃)
	Electrical Facility	AC100 ~ 240V/50 ~ 60Hz
Inlet water quality	Water turbidity	Down-flow regeneration < 5FTU; Up-flow regeneration < 2FTU
	Water hardness	First Grade Na+ < 6.5mmol/L; Second Grade Na+ < 10mmol/L
	Free chlorine	< 0.1mg/L
	Iron ²⁺	< 0.3mg/L
	CODMn	< 2mg/L (O ₂)

In the above table, First Grade Na+ represents First Grade Na+ Exchanger. Second Grade Na+ represents Second Grade Na+ Exchanger.

- When the water turbidity exceeds the conditions, a filter should be installed on the inlet of control valve.
- When the water hardness exceeds the conditions, the outlet water hardness will hardly reach the requirement of boiler feed water (0.03 mmol/L) . It is suggested to adopt second grade softener.

1.4.Product Structure and Technical Parameters

The appearance is just for reference.

It is subjected to the real product.

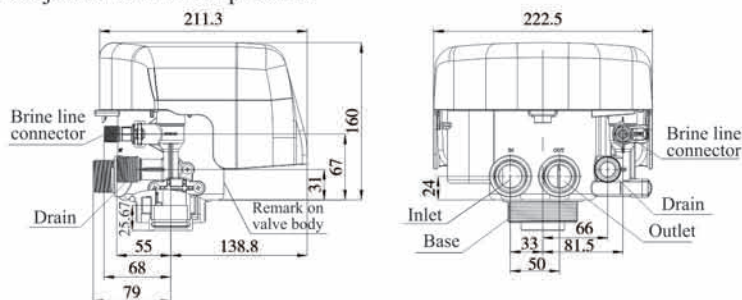

Remark on valve body		/		F92(Up-flow regeneration)					
		DF		F130(Down-flow regeneration)					
Connect Port Dimensions									
Product Model	Control Mode	Regeneration mode	Inlet	Outlet	Drain	Brine Line Connector	Base	Riser Pipe	Hard Water Bypass
73605	Meter Type	Up-flow	G1	G1	NPT3/4	G3/8	2.5"-8 NPSM	1" D-GB (Φ32)	No
73605B	Meter Type	Up-flow							Yes
73505	Time Clock Type	Up-flow							No
73505B	Time Clock Type	Up-flow							Yes
63605E	Meter Type	Down-flow							No
63605F	Meter Type	Down-flow							Yes
63505E	Time Clock Type	Down-flow							No
63505F	Time Clock Type	Down-flow							Yes
Main Technical Parameters									
Water Treatment Capacity m ³ /h	F92: 4.7 m ³ /h (0.1Mpa Pressure Drop); F130: 5.0 m ³ /h (0.1Mpa Pressure Drop)								
Power Input	AC100 ~ 240V/50 ~ 60Hz								
Power Output	DC12V, 2.0A								
Regeneration Mode	<p>A-01 Meter Delayed: Regenerate on the day although the available volume of treated water drops to zero (0). Regeneration starts at the regeneration time.</p> <p>A-02 Meter Immediate: Regenerate immediately when the available volume of treated water drops to zero (0).</p> <p>A-03 Intelligent Meter Delayed: Meter Delayed Regeneration type, but by setting Resin Volume, Raw Water Hardness, the controller will calculate the System Capacity. Regeneration mode is same as A-01.</p> <p>A-04 Intelligent Meter Immediate: Meter Immediately Regeneration Type, but by setting Resin Volume, Raw Water Hardness, the controller will calculate the System Capacity. Regeneration mode is same as A-02.</p> <p>A-05 Surplus Water Comparing: When the available volume of treated water is lower than average day water capacity of previous 7 days, regeneration starts at the regeneration time.</p> <p>A-06 Time Type by Day: Service days count down to zero (0), regeneration stars at the regeneration time.</p>								

1.5. Installation

A. Installation notice

Before installation, read all those instructions completely. Then obtain all materials and tools needed for installation.

The installation of product, pipes and circuits, should be accomplished by professional to ensure the product can operate normally.

Perform installation according to the relative pipeline regulations and the specification of water inlet, water outlet, drain outlet, and brine line connector.

B. Device location

- ① The filter or softener should be located closely to drain.
- ② Ensure the unit is installed in enough space for operating and maintenance.
- ③ Brine tank is needed to be close to softener.
- ④ The unit should be kept away from the heater and exposed to outdoor. Sunshine or rain will cause the system damage.
- ⑤ Please avoid installing the system in one acid/alkaline, magnetic or strong vibration circumstance, because above factors will cause the system disorder.
- ⑥ Do not install the filter or softener, drain pipeline in circumstance which temperature may drop below 5°C, or above 50°C.
- ⑦ Install the system in the place where with the minimum loss in case of water leaking.

C. Pipeline installation

① Install control valve

a. As the Figure 1 shows, select the riser pipe with 32mm OD, glue the riser pipe to the bottom strainer and put it into the mineral tank, cut off the exceeding tube out of tank top opening. Plug the riser tube in case of mineral entering.

b. Fill the mineral to the tank, and the height is accordance with the design code.

c. Install the top strainer to the valve.

d. Insert the riser tube into control valve through top strainer and screw tight control valve.

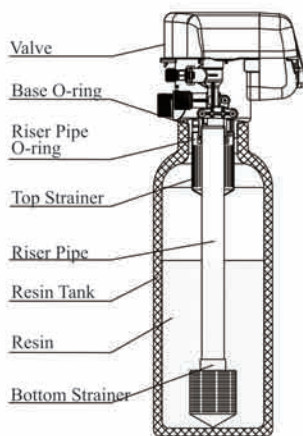

Figure 1

Note:

- The length of riser tube should not be lower 15mm than tank top opening height, lower than 8mm is advisable, and its top end should be rounded to avoid damage of O-ring inside the valve.
- Avoid filling floccules substance together with resin filled in the mineral tank.
- Avoid O-ring inside control valve falling out while rotating it on the tank.

② Install bypass valve (it is suitable for the installation of matched bypass valve)

As Figure 2 shows, put the gasket into the nut of animated connector, and screw in water inlet and outlet. Insert animated connector to bypass valve then insert clip.

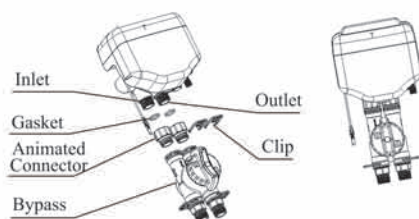

Figure 2

③ Install flow meter (it is suitable for the installation of matched flow meter)

As Figure 3 shows, put the gasket in the nut of animated connector of flow meter, and then screw the flow meter in water outlet. Please insert the flow meter line into slot of flow meter after pipeline installation.

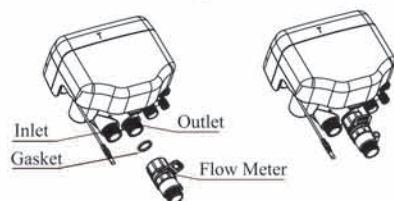

Figure 3

④ Pipeline connection (take the installation of control valve with bypass as an example)

As Figure 4 shows, inlet pipe connects with inlet connector of bypass via female connector. Outlet pipe connects with outlet pipe of bypass via female connector.

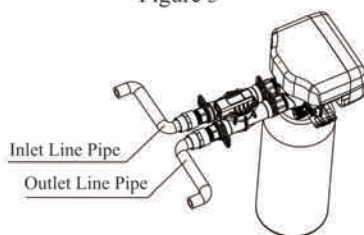

Figure 4

⑤ Install drain pipeline

- As the Figure 5 shows, Insert drain line flow control into drain outlet.
- Insert O-ring into O-ring slot of drain connector.
- Insert drain hose connector into drain outlet.
- Screw tightly drain hose connector into drain outlet.
- Locate the drain hose well as the Figure 5 show.

Notice

- Drain line pipe should be lower than valve, and the drain pipeline should not be longer than 3m. Otherwise, the inappropriate height or length will impact brine.
- Be sure not connect drain pipeline with sewer, and as Figure 5 shows, there is a certain space leaved between them to avoid wastewater being absorbed to the water treatment equipment.

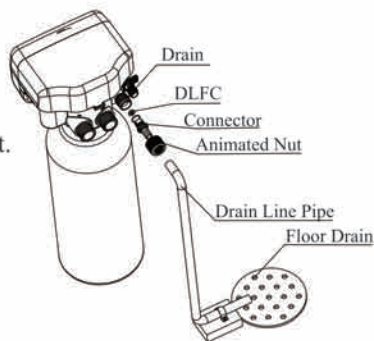

Figure 5

⑥ Connect brine tube

a. As Figure 6 shows, put drain line flow control into connector, and put O-ring.

b. Insert 3/8" nut into brine hose connector.

c. Insert the filter net into the tube, and insert the tube into brine hose connector.

d. Tighten the nut onto connector of valve, insert the connector into brine connector, and then insert clip.

e. Connect the other end of brine tube with the brine tank.

(the liquid level controller and air-blocker should be installed in the brine tank.)

Remark: The brine tube and drain pipeline should not be bended or plugged.

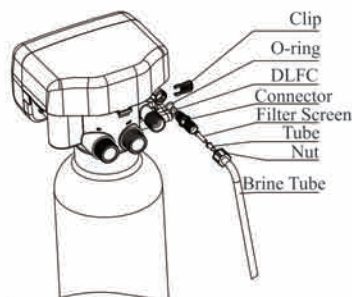

Figure 6

2. Basic Setting & Usage

2.1. The Function of PC Board



A. 🕒 Time of day indicator.

🕒 Lights on, the data indicates current time.

B. 🔒 Button lock indicator.

● 🔒 Lights on, indicates the buttons are locked. At this moment, it is useless to press any single button. (No operation in one minute, 🔒 will light on and lock the buttons.)

● Solution: Press and hold both ⬆️ and ⬇️ for 5 seconds until the 🔒 lights off.

C. 🔄 Program Mode indicator

● 🔄 lights on, enter program display mode, press ⬆️ or ⬇️ to view all values.

● 🔄 flashes, enter program set mode, press ⬆️ or ⬇️ to adjust all values.



D. 📄 Menu/Confirm button



● Press 📄, 🔄 lights on, enter program display mode and press ⬆️ or ⬇️ to view all values.

● In program display mode, press ,  flashes, enter program set mode, press  or  to adjust values.

● Press  after all program are set, and then the voice “Di” means all setting are success and return program display mode.

E.  Manual/Return button



● Press  in any status, it can proceed to next step. (Example: if the outlet water is unqualified, Press  in Service status, it will start regeneration cycles instantly; Press  while it is in Backwash status, it will end backwash and go to Brine & Slow Rinse at once.)

● Press  in program display mode, and it will return to service status; Press  in program set mode, and it will return program display mode.

● Press  while adjusting the value, then it will return program display mode directly without saving value.

F. Up  and Down 

● In program display mode, press  or  to view all values

● In program set mode, press  or  to adjust values.



● Press and hold both  and  for 5 seconds to unlock the buttons.





● When in parameter setting status or historical data record enquiry status, press  can back to program display mode, then press  again can back to service status.

● When in program set mode, press  to return program display mode without saving values.

2.2. Basic Setting & Usage

A. Parameter specification available to terminal user

Function	Indicate	Factory Default	Parameter set range	Instruction
Time of day		Random	00:00 ~ 23:59	Set the time of day; “:” flashes.
Water Treatment Capacity		50m ³	0 ~ 999.99 m ³	Water Treatment Capacity for one operation cycle (m ³)
Regeneration Time	02:00	02:00	00:00 ~ 23:59	Time when regenerate happens; “:” lights on.
Exchange Factor	AL.65	0.65	0.30 ~ 0.99	Related to raw water hardness, the higher the hardness is, the lower of exchange factor.
Resin Volume	20L	20L	5 ~ 500L	Resin volume in tank (L)
Raw Water Hardness	Yd1.2	1.2	0.1 ~ 9.9	Inlet water hardness (mmol/L)
Interval Backwash Times	F-00	F-00	0 ~ 20	Whether need backwash in every operation cycle

Backwash		10:00	0 ~ 99:59	Backwash time (min. :sec.)	
Brine & Slow rinse		60:00	0 ~ 99:59	Brine & slow rinses time (min. :sec.)	
Fast rinse		10:00	0 ~ 99:59	Fast rinse time (min. :sec.)	
Brine Refill		05:00	0 ~ 99:59	Brine refill time (min. :sec.)	
Service Days		1-03D	0 ~ 99 days	Only available for time type by day	
Maximum Interval Regeneration Days	H-30	30	0 ~ 40	Regenerate on the day even though the available volume of treated water does not drop to zero (Suitable for A-01/02/03/04/05).	
Enquiry Historical Record	Maximum flow rate in previous seven days	x.xx m ³ /h	/	/	Enquiry the maximum flow rate in previous seven days
	Regeneration times	xx	/	/	Enquiry the automatic regeneration times (It doesn't include manual regeneration).
Signal Output Mode	b-01	01	01 or 02	b-01:Signal output in the regeneration process (Refer to P5). b-02:Signal output in position of motor turning time (Refer to P6).	

B.Parameter specification available to technician and factory.

Function	Indication	Factory Default	Parameter set range	Instruction
Model of valve	73605	73605	73605/63605	73605 is up-flow brine draw valve. 63605 is down-flow brine draw valve.
On-line Program	C-01	C-01	C-01/02	C-01: Interlock C-02: One in service one standby
Data Reset	d-01	d-01	d-01/02	d-01=Data record d-02= Data reset
Control Mode	A-01	A-01	A-01	Meter Delayed: Regenerate on the day although the available volume of treated water drops to zero (0). Regeneration starts at the regeneration time.
			A-02	Meter Immediate: Regenerate immediately when the available volume of treated water drops to zero(0).
			A-03	Intelligent Meter Delayed: Meter Delayed Regeneration type, but by setting Resin Volume, Raw Water Hardness, Regeneration Factor, the controller will calculate the System Capacity. Regeneration mode is same as A-01.

Control Mode	A-01	A-01	A-04	Intelligent Meter Immediate: Meter Immediately Regeneration Type, but by setting Resin Volume, Raw Water Hardness, Regeneration Factor, the controller will calculate the System Capacity. Regeneration is same as A-02.
			A-05	Surplus Water Comparing: When the available volume of treated water is lower than average day water capacity of previous 7 days, regeneration starts at the regeneration time.
			A-06	Time Type by Day: Service days count down to zero(0),regeneration stars at the regeneration time.
Flow Rate Unit	m ³	HU-01	HU-01/02/03	02=gal, 03=L

C.Process Display



Figure A



Figure B



Figure C



Figure D



Figure E



Figure F

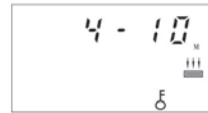

Figure G



Figure H











Illustration:











- The figure shows A,B,C and D repeatedly in service status. When in backwash status, shows E and C, in brine & slow rinse shows figure F and C. In fast rinse shows figure G and C. In brine refill shows figure H and C. Every figure will display 15 seconds.
- Figure A suits for control mode A-01/03/05. For A-02/04, it will not show regeneration time when in service. For A-06 the display data is service days when in service position.
- The display screen will only show “-00-” when motor is running.
- When the clock symbol flashes, like “12:12” flashes, it indicates long time power outage and reminds to reset the time.
- The display will show the error code, such as “-E1-” when the system is in error.
- Working process: Service→Backwash→Brine & Slow Rinse→Fast Rinse→Brine Refill→Service.

D. Usage

After being accomplished installation, parameter setting and trail running, the valve could be put into use. In order to ensure the quality of outlet water can reach the requirement, the user should complete the below works:

- ① Ensure that there is solid salt all the time in the brine tank in the course of using when this valve is used for softening. The brine tank should be added the crystalline coarse salt only, at least 99.5% pure, forbidding use the small salt and iodized salt.
- ② Test the outlet water and raw water hardness at regular time. When the outlet water hardness is unqualified, please press the  after unlock the buttons and the valve will temporarily regenerate again(it will not affect the original set operation cycle)
- ③ When the raw water hardness changes a lot, you can adjust the water treatment capacity as follow:

For control mode as A-01/02/05: Press and hold both  and  for 5 seconds to unlock the buttons. Press , then press  or  to select "set water treatment capacity", press  and digital numbers flash. Press  and  continuously, reset the capacity value. Press  and hear a sound "Di", then finish the adjustment. Press  exit and turn back the service status.

For control mode A-03/04: Press and hold both  and  for 5 seconds to lift the lock status. Press , then press  or  to select set raw water hardness", press  and digits flashes. Press  and  continuously, reset the raw water hardness value. Press  and hear a sound "Di", then finish the adjustment. Press  exit and turn back the service status.

When select A-03 or A-04 control mode, the control will automatically calculate the water treatment capacity by setting resin volume, feed water hardness and regeneration factor.

The regeneration parameters have been set when control valve left factory. Generally, it does not need to reset. If you want enquiry and modify the setting, you can refer to the professional application specification.

3.Applications

3.1. Softener Flow Chart

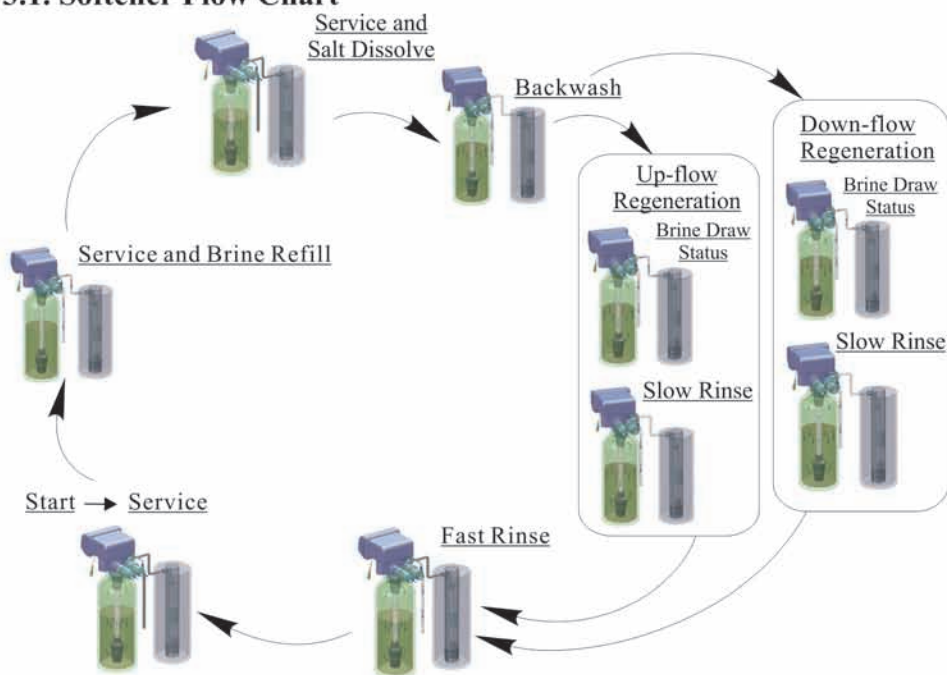

3.2. The Function and Connection of PC Board

Open the front cover of control valve, you will see the main control board and connection port as below:

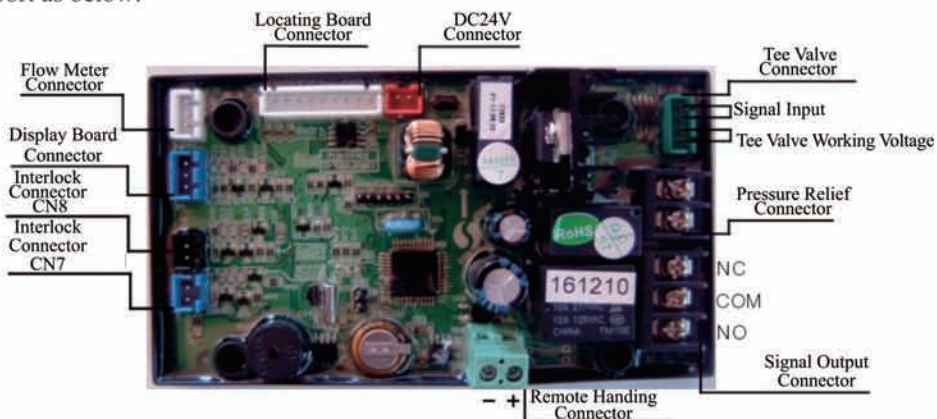

Figure 7

The main functions on main control board:

Function	Application	Explanation
Signal output connector b-01	Outlet solenoid valve	Used in strict requirements regarding no hard water flowing from outlet or controlling the liquid level in water tank.
	Inlet pump	Increase pressure for regeneration or washing Use the liquid level controller to control inlet pump to ensure there is water in tank.
Signal output connector b-02	Inlet solenoid valve or inlet pump	When inlet pressure is high, it needs to close water inlet to protect motor when valve is rotating.
Tee valve connector	Connect with tee valve to two control valves' outlet	When both two valves are set one in service one standby program, use tee valve will make one valve supplying water while another one standby when both valves are in service status.
Interlock connector	To ensure no more than one control valve regenerate or wash in system.	Use in RO Pre-treatment, water supply together but regeneration in turn. Second grade ion exchange equipment, etc.
Remote handling connector	Receive signal to make the control valve rotate to next status.	It is used for on-line inspection system, connected with PC to realize automatically or remote controlling valve.

A. Signal Output Connector

1) Control Outlet Solenoid Valve (Set b-01)

① Solenoid Valve on Outlet Controls Water Level in Brine Tank.

Instruction: If system requires no hard water flowing from outlet in regeneration cycle (Mainly for no hard water flows out when valve is switching or valve in backwash or brine drawing positions), a solenoid valve could be installed on outlet, the wiring refer to Figure 8.

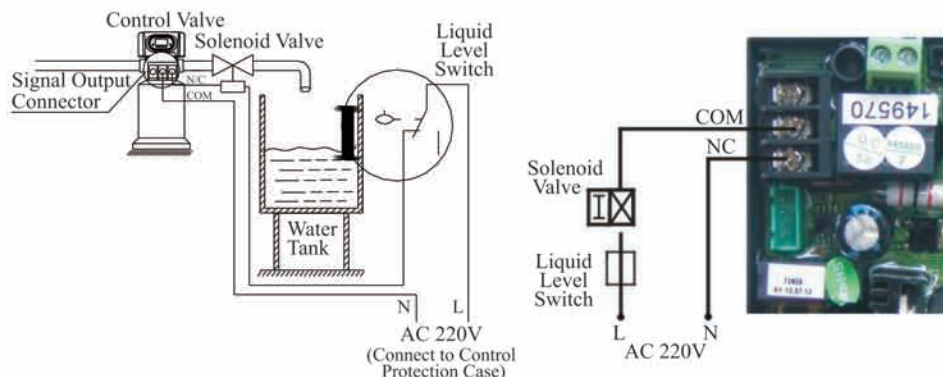

Figure 8 Wiring of Solenoid Valve on Outlet

Function:

When valve is in service status, if soft water tank is short of water, solenoid valve will open to supply soft water, but if water tank has enough water, solenoid valve will close, so no soft water supplied to the tank.

When the valve is in backwash status, there is no signal output. So, solenoid valve will close, and no raw water flows into soft water tank.

②Control Inlet Solenoid Valve (Set b-02)

Instruction: When inlet pressure exceeds 0.6MPa, install a solenoid valve on inlet. Control mode is b-02. Pressure is relieved when valve switching, the wiring refers to Figure 9.

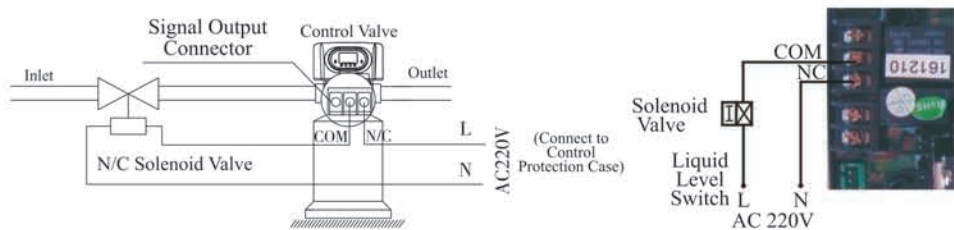

Figure 9 Wiring of Solenoid Valve on Inlet

Function:

When inlet pressure is high, install a solenoid valve on inlet to ensure valve switches properly. The solenoid valve will open when valve is exactly at status of Service, Backwash, Brine & Slow Rinse, Brine Refill and Fast Rinse. When valve is switching, solenoid valve is closed, no water flows into valve to ensure valve switching properly. It could prevent the problem of mixing water and water hammer.

Use interlock cable to realize valves in parallel and series in same system which is suited for RO pretreatment system or second grade Na⁺ system. The Wiring refers to Figure 10:

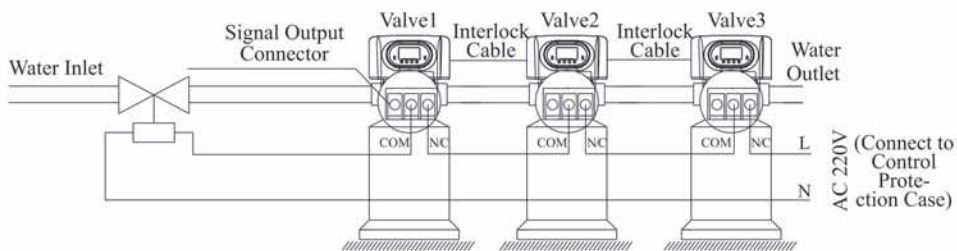

Figure 10 Wiring of Solenoid Valve in Inlet

2) Liquid Level Controller Controls Inlet Pump(Two-phase Motor)(Set b-01)

Instruction: For the system using under ground water or middle-tank supplying water, users can turn on and turn off the pump by operating the switch of liquid level controller and valve. The wiring refers to Figure11:

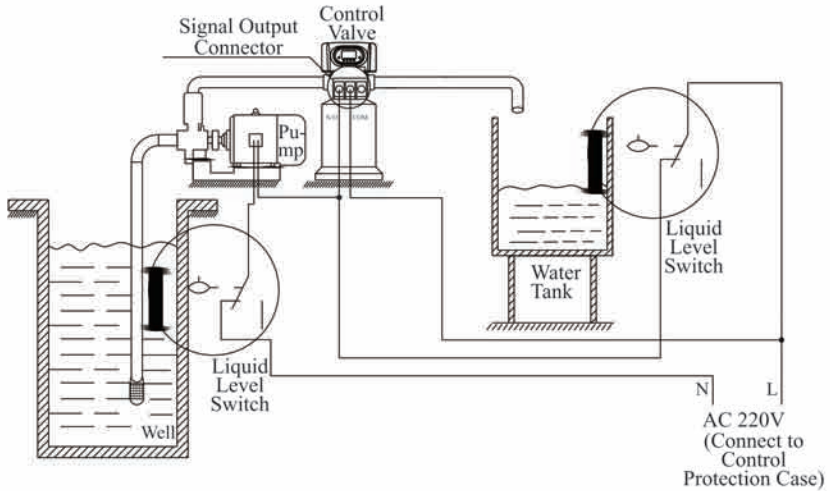

Figure 11 Wiring of Liquid Level Controller Controlling Inlet Pump

Function:

When valve is in service status, if water tank is short of water, pump starts working, but if water tank has enough water, the switch of liquid level controller is closed, so pump doesn't work.

When valve in regeneration cycle, inlet always has water no matter what is water condition in water tank. A liquid switch at the top opening of well or middle water tank in RO system protects pump from working without water in case of out of raw water.

3) Liquid Level Switch in Water Tank Controls Inlet pump (Three-phase, figure 12) (Set b-01)

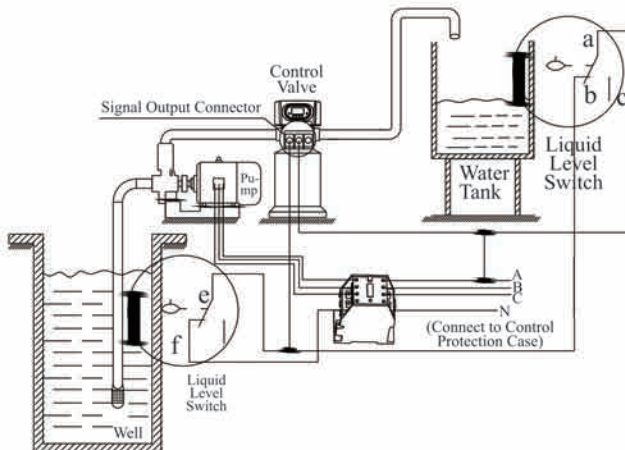

Figure 12 Wiring of Liquid Level Switch in Water Tank Controls Inlet Pump

4) Control Inlet Booster Pump(Set b-01 or b-02)

Instruction: If inlet water pressure is less than 0.15MPa, which makes backwash or rinse draw difficult, a booster pump is suggested to be installed on inlet. Set control mode as b-01. When system in regeneration cycle, booster pump opens, the wiring refers to Figure 13. If the booster pump current is bigger than 5A, system need to install an contactor, the wiring refers to Figure14.

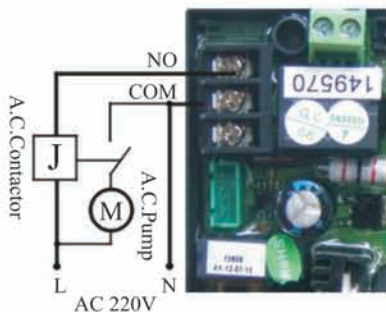
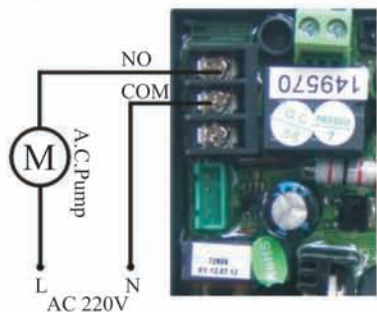

Figure13 Wiring of Booster Pump on Inlet Figure 14 Wiring of Booster Pump on Inlet

B. Interlock

Instruction: In the parallel water treatment system, it ensures only one valve in regeneration or washing cycle and (n-1) valves in service, that is, realizing the function of supplying water simultaneously and regenerating individually.

In the series and parallel water treatment system(Second grade Na⁺ Exchanger or RO pre-treatment system), it ensure only one valve in regeneration or washing cycle and there is/are water(s) in service, the wiring refer to Figure15:

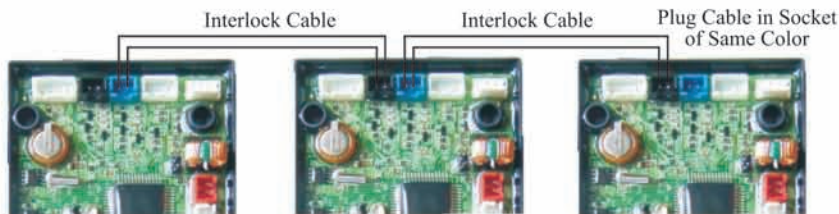

Figure15 Interlock Connect

Use Interlock Cable to connect CN8 to CN7 on next valve in the loop.

One system with several valves, if interlock cable is disconnected, the system is divided into two individual system.

C. One in service one standby

Instruction: Used in two valves supply water continuously system, it ensures there is always one valve supplying water and another is waiting or in regeneration, the wiring refers to Figure16:

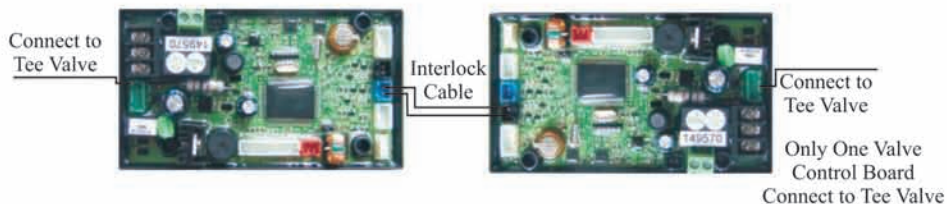

Figure16 Wiring of One in Service One Standby

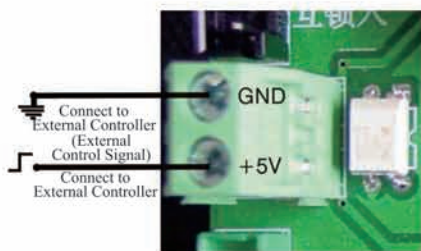

Figure17 Wiring of Remote Input

D. Remote Handling Connector

When the valve is used to make pure water or other system that can be monitored online or connected to a PC, etc., when the conductivity or other parameters reach the set value or the PC sends a signal and needs system regeneration, it can be provide a signal to remote handling connector of main control board by the signal line, which can make the valve regenerate immediately. The connector receiving the signal is equivalent to pressing the manual button. The wiring refers to Figure 17:

E. Interlock System

2 or more valves are interlocked connecting in one system can be realized. The wiring refers to Figure18.

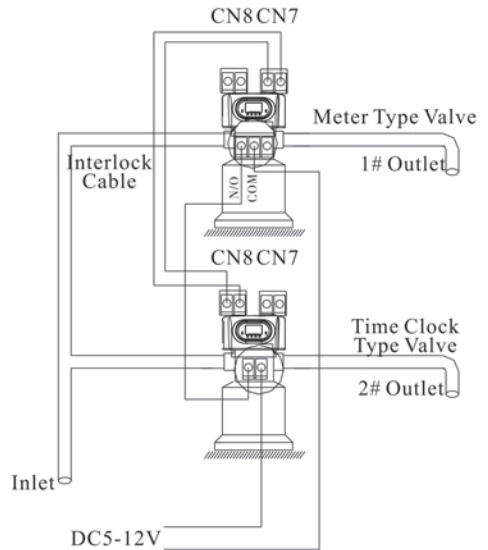
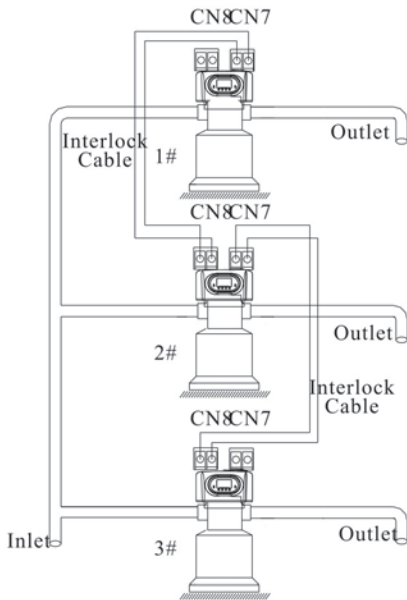

Figure18 All in service, regenerate individually Figure19 All in service, regenerate sequence

F. Series System

This is a 2 or more than 2 valves system, all in service, with one flow meter for the entire system. For the time type valve, the regeneration time should be set and adjusted to the Max; for the meter type valve, connect its signal output connector with the remote handle connector of the time-type valve. That can realize the function of supplying water simultaneously and regenerating orderly. The wiring refers to Figure19:

3.3. System Configuration and Flow Rate Curve

A. Product configuration with tank, resin volume, brine tank and injector

Tank Diameter mm	Resin Volum (L)	Water Capacity (m ³ /h)	Brine Tank L	Minimum regeneration salt usage (Kg)	Injector Model
Φ 250 × 1390	40	1.5	100	6.0	6302
Φ 300 × 1650	60	2.0	100	9.0	6303
Φ 350 × 1650	100	2.5	200	15.0	6305
Φ 400 × 1650	125	3.5	200	18.0	6307
Φ 450 × 1650	150	4.5	300	18.7	6308
Φ 500 × 1750	200	6.0	300	30.0	6309
Φ 550 × 1750	280	7.0	500	42.0	6310

Attention: The flow rate calculation is based on linear velocity 25m/h; the minimum salt consumption for regeneration calculation is based on salt consumption 150g / L (Resin).

B. Matched with bypass valve 41206AL (F70F)

C. Matched with flow meter (No. 5447018)

D. Flow Rate Characteristic

Pressure-flow rate curve

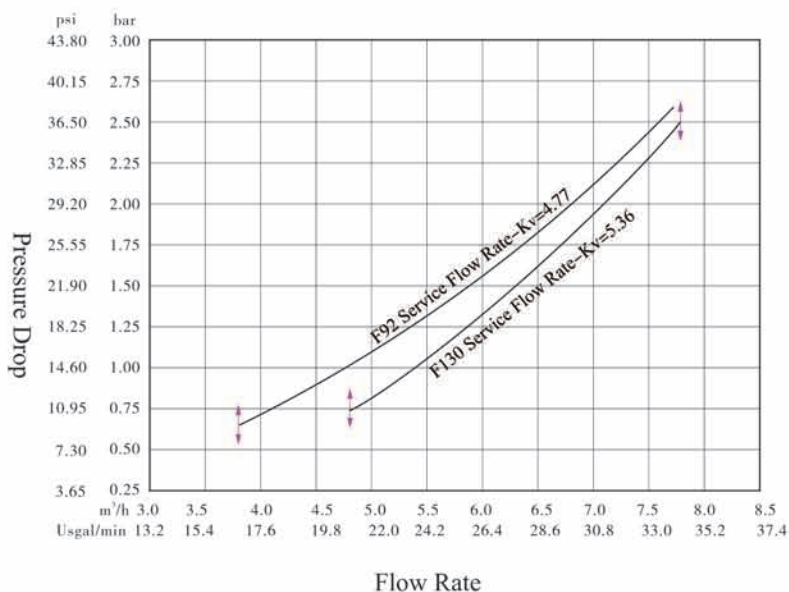

2) Injector parameter table

Inlet Pressure	(L/M) Flow Rate on Injector									
	6301 Coffee	6302 Pink	6303 Yellow	6304 Blue	6305 White	6306 Black	6307 Purple	6308 Red	6309 Green	6310 (see remark)
0.15	1.19	1.5	2.25	2.86	3.21	3.88	4.08	4.38	5.55	6.20
0.20	1.38	1.75	2.6	3.3	3.8	4.46	4.73	5.18	6.61	7.00
0.25	1.58	1.93	2.87	3.62	4.21	4.95	5.28	6.2	7.3	7.90
0.30	1.72	2.11	3.17	3.99	4.58	5.19	5.76	6.72	7.68	8.65
0.35	1.84	2.26	3.35	4.28	5.05	5.48	6.15	7.23	8.45	9.22
0.40	2.46	2.4	3.58	4.6	5.35	5.71	6.45	7.52	8.8	9.65

Remark: Injector 6310 consists of yellow nozzle and green throat.

3).Configuration for Standard Injector and Drain Line Flow Control

Tank Dia-meter mm	Model	Injector Model	Total Flow Rate on Injector	Flow Rate of Slow Rinse	Part number of BLFC	Flow Rate of Brine Refill	Part Number of DLFC	Flow Rate of Backwash and Fast rinse
			L/m	L/m		L/m		L/m
175	F92	6301	1.72	1.04	8468057	0.83	8468043	4.31
	F130	6302	2.11	1.27				
200	F92	6301	1.72	1.04	8468056	1.13	8468042	7.15
	F130	6303	3.17	1.75				
225	F92	6302	2.11	1.27	8468056	1.13	8468060	7.64
	F130	6303	3.17	1.75				
250	F92	6302	2.11	1.27	8468052	1.47	8468061	10.82
	F130	6304	3.99	2.46				
300	F92	6303	3.17	1.75	8468053	3.14	8468045	15.96
	F130	6306	5.19	3.12				
325	F92	6304	3.99	2.46	8468053	3.14	8468045	15.96
	F130	6308	6.72	4.17				
350	F92	6305	4.58	2.75	8468054	4.99	8468044	18.5
	F130	6308	6.72	4.17				
400	F92	6307	5.76	3.55	8468055	5.6	8468062	24.97
	F130	6309	7.68	5.04				
450	F92	6308	6.72	4.17	8468055	5.6	8468063	30.64
	F130	6310	8.65	6.27				

500	F92	6309	7.68	5.04	8468055	5.6	Without flow control	52.00
	F130	6310	8.65	6.27				
550	F92	6310	8.60	6.27	8468055	5.6	Without flow control	52.00
	F130	6310	8.65	6.27				

4) Configuration for BLFC

Part Number	8468057	8468056	8468052	8468053	8468054	8468055
Flow Rate L/m	0.83	1.13	1.47	3.14	4.99	5.6

5) Configuration for DLFC

Part Number	8468064	8468043	8468042	8468060	8468061	8468045	8468044	8468062	8468063	Without flow controller
Flow Rate L/m	3.33	4.31	7.15	7.64	10.82	15.96	18.5	24.97	30.64	52.00

Note: Above configuration and related curve for reference only.

3.4. Parameter settlement

① T1 Service time T1

Service time T1

Water treatment capacity: $Q = V_R \times K \div Y_D$ (m³)

Hardness of Inlet Water, mmol/L.

Exchange factor, (mmol/L), 400~1000.
Down-flow regeneration, take 400~750.
Up-flow regeneration, take 450~1000.
If the inlet water hardness is higher, the factor is smaller.

Resin volume (m³).

By hours: $T1 = Q \div Q_h$ (Hour)

Average water consumption per hour (m³/h)

Water treatment capacity (m³)

By days: $T1 = Q \div Q_d$ (Day)

Average water consumption per day (m³/h)

Water treatment capacity (m³)

② Backwash time T2

Generally, It is suggested to be set 10 ~ 15 minutes. The higher the turbidity is, the longer backwash time can be set. However, if the turbidity is more than 5FTU, it should be better to install a filter in front of the exchanger.

③ Brine & slow rinse time T3

$$T3 = (40 \sim 50) \times H_R \text{ (min)}$$

Generally, $T3 = 45H_R$ (min)

In this formula, H_R — the height of resin in exchange tank (m)

④ Brine refill time T4

$$T4 = 0.34 \times V_R \div \text{Brine refill speed (min)}$$

In this formula, V_R — Resin volume (m^3)

⑤Fast rinse time T5

$T5=12 \times H_R$ (min)

Generally, the water for fast rinse is 3 ~ 6 times of resin volume. It is suggested to be set 10 ~ 16 minutes, but it should meet the requirement of qualified outlet water.

⑥Exchange factor

Exchange factor= $E/(k \times 1000)$

In this formula, E—Resin working exchange capability (mol/m^3) , it is related to the quality of resin. Down-flow regeneration, take 800 ~ 900. Up-flow regeneration, take 900 ~ 1200.

K—Security factor, always take 1.2 ~ 2. it is related to the hardness of inlet water: the higher the hardness is, the bigger the K is.

⑦Regeneration time: The whole cycle for regeneration is about two hours. Please try to set up the regeneration time when you don't need to use water according to the actual situation.

The calculation of parameters for each step is only for reference, the actual proper time will be determined after adjusting by water exchanger supplier. This calculation procedure of softener is only for industrial application; it is not suitable for small softener in residential application.

3.5. Parameter Enquiry and Setting

(1)Terminal User Parameter Enquiry

When \odot lights on, press and hold both \blacktriangle and \blacktriangledown for 5 seconds to unlock buttons; then press \square , enter program display mode; press \blacktriangle or \blacktriangledown to view each value according to below process.(Press \square exit and turn back to service status) Take control mode A-01 for example:

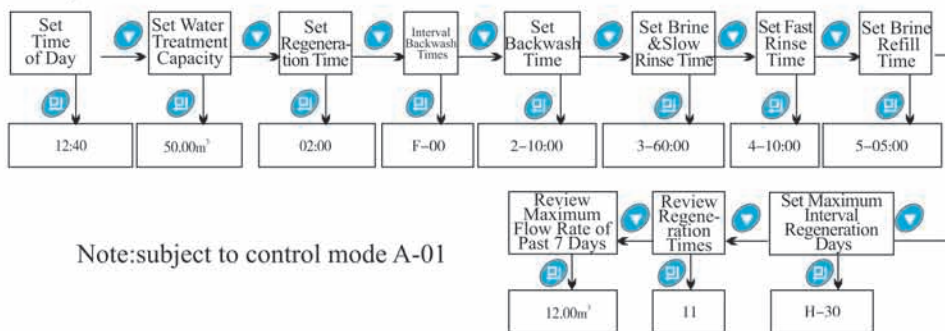

Note:subject to control mode A-01

(2)Technician or Factory Parameter Enquiry



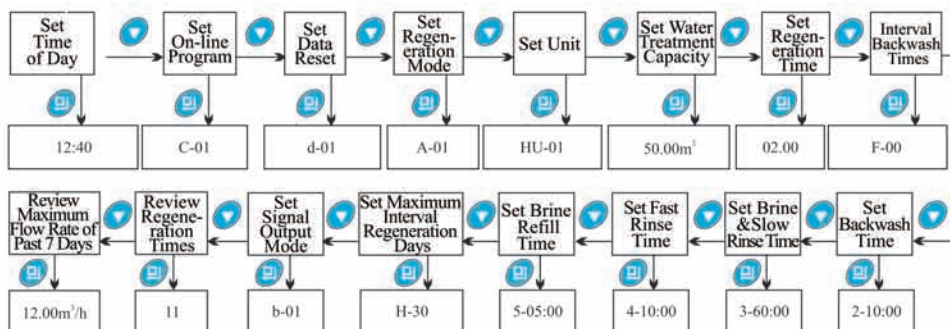









































Power on, press \square , \square and \blacktriangledown in sequence can enter into technician or factory parameter enquiry and setting status. Press \blacktriangle or \blacktriangledown following below operation sequence can enquiry relevant parameter (Press \square to turn back).Take control mode A-01 for example:

































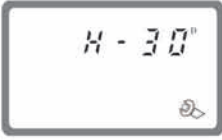







(3) Parameter Setting and Enquiry Step One (Available for Technician, Factory and End User)







In program set mode, press or can adjust every parameter, following is the parameters setting example when control mode is A-03:





























Item	Steps	Symbol
Time of Day	<p>When time of day “12:12” continuously flashes, it reminds to reset;</p> <p>1. Press to enter program display mode; both and symbol light on, “:” flashes; Press , both and hour value flash, through or to adjust the hour value;</p> <p>2. Press again, both and minute hour value flash, through or to adjust the minute value;</p> <p>3. Press and finish adjustment, press to turn back.</p>	
Water Treatment Capacity	<p>1. In water treatment capacity display program status display and 50.00, then press and enter program set mode. And 50.00 Flash.</p> <p>2. Press or to adjust the water treatment capacity value (m³) ;</p> <p>3. Press and finish adjustment, press to turn back.</p>	
Regeneration Time	<p>1. In regeneration time program display status, display 02:00, then press and enter program set mode. and 02 flash. Press or to adjust hour value.</p> <p>2. Press or , and 00 flash, press to adjust minute value.</p> <p>3. Press and finish adjustment, press to turn back.</p>	

<p>Exchange Factor</p>	<p>1. In exchange factor program display status, displays AL.55, press  enter program set mode.  and 55 flash. 2. Press  or  to adjust the exchange factor. 3. Press  and finish adjustment, press  to turn back.</p>	
<p>Resin Volume</p>	<p>1. In resin volume program display status, for example, if screen shows 20L, then press  enter program set mode.  and 20 flash. 2. Press  or  to adjust the resin volume. 3. Press  and finish adjustment, press  to turn back.</p>	
<p>Raw Water Hardness</p>	<p>1. In raw water hardness program display status, show as yd1.2, then press  enter program set mode.  and 1.2 flash. 2. Press  or  to adjust the raw water hardness. 3. Press  and finish adjustment, press  to turn back.</p>	
<p>Interval Backwash Times</p>	<p>1. In interval backwash times program display status, show as F-00, then press  enter program set mode.  and 00 flash. 2. Press  or  to adjust the interval backwash times. 3. Press  and finish adjustment, press  to turn back.</p>	
<p>Backwash Time</p>	<p>1. In backwash time program display status, show as  and 2-10: 00, then press  enter program set mode.  and 10:00 flash. 2. Press  or  to adjust backwash time. 3. Press  and finish adjustment, press  to turn back.</p>	
<p>Brine& Slow Rinse Time</p>	<p>1. In brine& slow rinse time program display status, show as  and 3-60: 00, then press  enter program set mode.  and 60:00 flash. 2. Press  or  to adjust brine& slow rinse time. 3. Press  and finish adjustment, press  to turn back.</p>	











Fast Rinse Time	<p>1. In fast rinse time program display status, show as  and 4-10: 00, then press  enter program set mode.  and 10:00 flash.</p> <p>2. Press  or  to adjust fast rinse time.</p> <p>3. Press  and finish adjustment, press  to turn back.</p>	
Brine Refill Time	<p>1. In brine refill time program display status, show as  and 5-05: 00, then press  enter program set mode.  and 05:00 flash.</p> <p>2. Press  or  to adjust brine refill time.</p> <p>3. Press  and finish adjustment, press  to turn back.</p>	
Maximum Interval Regeneration Days	<p>1. In maximum interval regeneration days program display status, show as H-30, then press  enter program set mode.  and 30 flash.</p> <p>2. Press  or  to adjust maximum interval regeneration days.</p> <p>3. Press  and finish adjustment, press  to turn back.</p>	
Maximal flow rate of previous seven days	<p>1. Press  in working status to enter program display status,  and number light on. Press  or  to view the maximal flow rate of previous 7 days.</p> <p>2. Press  back to working status after enquiry.</p>	
Review Regeneration Times	<p>1. Press  in working status to enter program display mode,  and number light on, and then press  or  to review regeneration times.</p> <p>2. Press  to turn back.</p>	

(4)Parameter Setting and Enquiry Step Two (Available for Technician and Factory)
Power on, press ,  and  in sequence can enter into technician and factory setting status. Parameters set as below:

On-line Program	<p>1. In On-line program display status, it shows C-01, press  enter program set mode,  and 01 flash.</p> <p>2. Press  or  to select preference program (C-02)</p> <p>3. Press  to finish on-line program select, press  to return.</p>	
-----------------	-----------------------------------------------------------------------------------------------------------------------------------------------------------------------------------------------------------------------------------------------------------------------------------------------------------------------------------------------------------------------------------------------------------------------------------------------------------------------------------------------------------------------------------------------------------------------------------------------------------------------------------------------------------------------------------------------------------------------------------------------------------	-------------------------------------------------------------------------------------

Set Clear Data	<p>1.In set clear data display status, it shows d-01, press  enter program set mode,  and 01 flash.</p> <p>2.Press  or  to alter to d-02.</p> <p>3.Press  to finish clear data change, press  to return.</p>	
Control Mode	<p>1.In control mode display status, press , enter program set mode,  and 01 flash.</p> <p>2.Press  or  select control mode among A-01/02/03/04/05/06.</p> <p>3.Press  to finish control mode adjustment, press  to return.</p>	
Flow Rate Unit	<p>1.In water yield unit display status, press , enter program set mode,  and 01 flash.</p> <p>2.Press  or  select among m3/L/gal.</p> <p>3.Press  to finish flow rate unit adjustment, press  to return.</p>	
Signal Output Mode	<p>1.In signal output mode display status, it shows b-01, press  enter into setting status,  and 01 flash.</p> <p>2.Press  or  to alter to b-02.</p> <p>3.Press  to finish signal output mode change, press  to return.</p>	

For example, the fast rinse time of a softener is 12 minutes. After regenerating, the chloridion in the outlet water is always higher than normal, indicating that there is not enough time for fast rinse. If you want the time to set to 15 minutes, the modification steps as follows:

- ① Press  and  hold both and to unlock the buttons. ( lights off);
- ② Press  and enter program display mode;
- ③ Press  or  to select set fast rinse program;
- ④ Press , fast rinse time value flashes;
- ⑤ Press  or  until 12 is changed to 15;
- ⑥ Press , there is a sound “Di” and the figure stop flashing; the program back to program display mode.
- ⑦ If you want to adjust other parameters, you can repeat the steps from ② to ⑤; If you don't, press  and quit from the program display mode, the display will show the current service status.

3.6.Trial running

After installing the multi-functional flow control valve on the resin tank with the connected pipes, as well as setting up the relevant parameter, please conduct the trial running as follows:

A.Open the bypass, after cleaning the impurity in the pipe, close the bypass.

B.Add calculated water to the brine tank and adjust the height of liquid level switch. Then add solid salt to the tank and dissolve the salt as much as possible.

C.Switch on power. Press  and turn to the Backwash position; you can hear the sound of air-out from the drain pipeline. After all air is out of pipeline, clean the foreign materials in the resin tank until the outlet water is clean. It will take 8~10 minutes to finish the whole process.

D.Press , turning the position from Backwash to Brine& Slow Rinse; enter in the process of Brine& Slow Rinse. The air check valve will turn off when control valve finished brine draw, then slow rinse starts to work. It takes about 60~65minutes for whole process.

E.Press , and turn the status from Brine & Slow Rinse to Fast Rinse position. It takes about 10 minutes, take out some outlet water for testing: if the water hardness reach the requirement, and the chloridion in the water is almost the same compared with the inlet water, then go to the next step.

F.Press , and turn the status from Fast Rinse to Brine Refill. Users can record the brine refill time and set it as needed.

G.Press , making the control valve return to Service Status.

Note:

- When the control valve enters into the regeneration status, all program can be finished automatically according to the setting time; if you want one of steps to be terminated early, you can press .
- If water inflow too fast, the media in tank will be damaged. When water inflow slowly, there is a sound of air emptying from drain pipeline.
- After changing resin, please empty air in the resin according to the above Step C.
- In the process of trial running, please check the water situation in all position, and ensure there is no resin leakage.
- The time for Backwash, Brine& Slow Rinse, Brine Refill and Fast Rinse status can be set and executed according to the calculation in the formula or suggestions from the control valve suppliers.

3.7. Trouble-Shooting

A. Control Valve Fault

Problem	Cause	Correction
1. Softener fails to regenerate.	A. Electrical service to unit has been interrupted. B. Regeneration cycles set incorrect. C. Controller is defective. D. Motor fails to work.	A. Assure permanent electrical service (Check fuse, plug, pull chain or switch). B. Reset regeneration cycles. C. Check or replace controller. D. Check or replace motor.
2. Regeneration time is not correct.	A. Time of Day does not set correctly. B. Power failure more than 3 days, the time of day is incorrect.	Check program and reset time of day.
3. Softener supply hard water.	A. Bypass valve opens or leaks. B. No salt in brine tank. C. Injector is plugged. D. Insufficient water flows into brine tank. E. O-ring on riser pipe leaks. F. Internal valve leaks. G. Incorrect regeneration time or raw water quality deterioration. H. Shortage of resin. I. Bad quality of raw water or turbine is blocked.	A. Close or repair bypass valve. B. Add salt to brine tank and maintain salt level above water level. C. Change or clean injector. D. Check brine tank refill time. E. Make sure riser pipe is not cracked. Check o-ring and tube pilot. F. Change valve body. G. Set correct regeneration time or water capacity treatment. H. Add resin to mineral tank and check whether resin leaks. I. Reduce the inlet turbidity, clean or replace turbine.
4. Softener fails to draw brine.	A. Inlet line pressure is too low. B. Brine line is plugged. C. Brine line is leaking. D. Injector is plugged or broken down. E. Internal valve leaks. F. Drain line is plugged. G. Sizes of injector and DLFC are not matched with tank.	A. Increase inlet line pressure. B. Clean brine line. C. Replace brine line. D. Clean or replace new injector. E. Replace valve body. F. Clean drain line flow control. G. Select correct injector size and DLFC according to the P23 requirements.
5. Unit used too much salt.	A. Improper salt setting. B. Excessive water in brine tank.	A. Check salt usage and salt setting. B. See problem no.6.

Control Valve Fault

<p>6.Excessive water in brine tank.</p>	<p>A. Overlong refilling time. B. Too much water left after brine draw. C. Foreign material in brine line. D. Power outage when brining and system without liquid level controller. E. Brine refill is out of control. F. Brine motor is broken.</p>	<p>A. Reset correct brine refilling time. B. Check the injector and make sure no stuff in the brine pipe. C. Clean brine valve and brine line. D. Stop water supplying and equip the liquid level controller. E. Repair or replace liquid level controller. F. Check the brine motor.</p>
<p>7. Pressure lost or rust in pipeline</p>	<p>A. Iron in the water supply pipe. B. Iron mass in the softener. C. Fouled resin bed. D. Too much iron in the raw water.</p>	<p>A. Clean the water supply pipe. B. Clean valve and add resin cleaning chemical, increase frequency of regeneration. C. Check backwash, brine draw and brine tank refill. Increase frequency of regeneration and backwash time. D. Iron removal equipment is required to install before softening.</p>
<p>8. Loss of mineral through drain line.</p>	<p>A. Air in water system. B. Strainer is broken. C. Improperly sized drain line control.</p>	<p>A. Assure that well system has proper air eliminator control. B. Replace new bottom strainer. C. Check for proper drain rate.</p>
<p>9. Control cycle continuously.</p>	<p>A. Locating signal wiring breakdown. B. Controller is faulty. C. Foreign material stuck the driving gear. D. Time of regeneration steps were set to zero.</p>	<p>A. Check and connect locating signal wiring. B. Replace controller. C. Take out foreign material. D. Check program setting and reset.</p>
<p>10. Drain flows continuously.</p>	<p>A. Internal valve leaks. B. Power off when valve is in backwash or fast rinse status.</p>	<p>A. Check and repair valve body or replace it. B. Adjust valve to service position or turn off bypass valve and restart when electricity supply.</p>
<p>11. Interrupted or irregular brine.</p>	<p>A. Water pressure is too low or not stable. B. Injector is plugged or faulty. C. Air in resin tank. D. Floccules in resin tank during up-flow regeneration.</p>	<p>A. Increase water pressure. B. Clean or replace injector. C. Check and find the reason. D. Clean the floccules in resin tank.</p>
<p>12. Water flows out from drain or brine pipe after regeneration.</p>	<p>A. Foreign material in valve which makes valve can't be closed completely. B. Hard water mixed in valve body. C. Water pressure is too high which results in valve not getting the right position. D. Under the Backwash position, pipelines between the outlet and brine line are communicated.</p>	<p>A. Clean foreign material in valve body. B. Change valve core or sealing ring. C. Reduce water pressure or use pressure relief function. D. Install a check Valve, solenoid valve in front of the outlet or install a liquid level controller in the brine tank.</p>

Control Valve Fault

13.Salt water in outflow pipeline.	A. Foreign material in injector or injector fails to work. B. Brine valve cannot be shut-off. C. Time of rapid rinse is too short.	A. Clean and repair injector. B. Repair brine valve and clean it. C. Extend rapid rinse time.
14.Unit capacity decreases.	A. Doesn't regenerate properly. B. Fouled resin bed. C. Salt setting is not proper. D. Softener setting is not proper. E. Raw water quality deteriorated. F. Turbine of flow meter is stuck.	A. Regenerate according to the correct operation requirement. B. Increase backwash flow rate and times, clean or change resin. C. Readjust brine drawing time. D. According to the test of outlet water, recount and reset. E. Regenerate unit by manual temporary, then reset regeneration cycle. F. Disassemble flow meter and clean it or replace a new flow meter.

B. Controller Fault

Problem	Cause	Correction
1. All indicators display on front panel.	A. Wiring of display board with control board fails to work. B. Control board is faulty. C. Transformer is damaged. D. Electrical service is not stable.	A. Check and replace the wiring. B. Replace control board. C. Check and replace transformer. D. Check and adjust electrical service.
2. No display on front panel.	A. Wiring of display board with control board fails to work. B. Display board is damaged. C. Control board is damaged. D. Electricity is interrupted.	A. Check and replace wiring. B. Replace display board. C. Replace control board. D. Check electricity.
3. E1 Flash	A. Wiring of locating board with control board fails to work. B. Locating board damaged. C. Mechanical driven failure. D. Faulty control board. E. Wiring of motor with control board is fault. F. Motor is damaged.	A. Replace wiring. B. Replace locating board. C. Check and repair mechanical part. D. Replace control board. E. Replace wiring. F. Replace motor.
4. E2 Flash	A. Hall component on locating board is damaged. B. Wiring of locating board with control board fails to work. C. Control board is faulty.	A. Replace locating board. B. Replace wiring. C. Replace control board.
5. E3 or E4 Flash	A. Control board is faulty.	A. Replace control board.

6.Full screen display then display model, circularly display.	A.Motor stuck or short circuit. B.Ball valve stuck or short circuit. C.Three way ball valve stuck or short circuit.	A.Replace the motor. B.Replace the ball valve. C.Replace three way ball valve.
7.Fails to realize Interlock or one in service one standby.	A.Menu setting improper. B.Interlock wiring insert improperly. C.Three way ball valve wiring insert improperly.	A.Reset B.Re-insert wiring C.Re-insert wiring

8.Assembly & Parts

73605 and 63605 Valve Structure

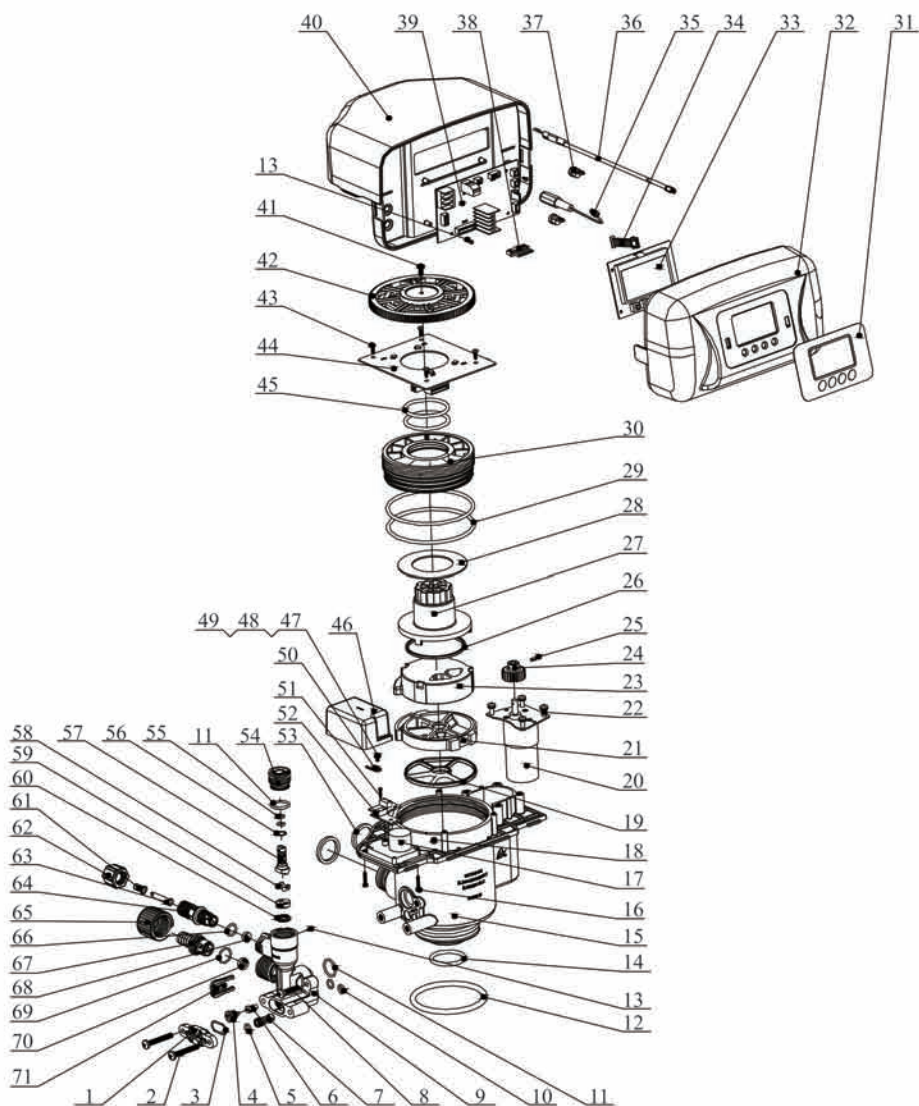

73605 and 63605 Spare parts and part no.

Item Number	Description	Part number	Quantity
1	Cover, Injector	8315003	1
2	Screw, Cross	8902017	2
3	O-ring	8378148	1
4	Nozzle, Injector	8454009	1
5	O-ring	8378015	1
6	Throat, Injector	8467009	1
7	Filter Screen	5336008	1
8	Screw, Cross	8902015	1
9	Injector Body	8008008	1
10	O-ring	8378016	2
11	O-ring	8378182	2
12	O-ring	8378143	1
13	Screw, Cross	8909004	3
14	O-ring	8378116	1
15	F92 Valve Body	5022047	1
	F130 Valve Body	5022132	
16	Screw, Cross	8909027	2
17	Motor	6158052	1
18	Screw, Cross	8909023	4
19	Seal Ring	8370075	1
20	Motor	6158012	
21	F92A Fixed Disk	8469048	1
	F92B Fixed Disk	8469049	
	F130A Fixed Disk	8469104	
	F130B Fixed Disk	8469097	
22	Screw	8909044	4
23	F92 Moving Disk	8459050	1
	F130 Moving Disk	8459095	
24	Small Gear	8241019	1
25	Pin	8993003	1
26	Moving Seal Ring	8370065	1
27	Shaft	8258014	1
28	Anti-friction Washer	8216012	1
29	O-ring	8378180	2
30	Fitting Nut	8092033	1
31	Label	8865040	1
32	Front Cover	8300034	1

33	Display Board	6381003	1
34	Wire for Display Board	5512001	1
35	Wire for Power	5513001	1
36	Probe Wire	6386001	1
37	Cable Clip	8126004	2
38	Wiring of Locating Board	5511014	1
39	Control Board	6382024	1
40	Dust Cover	8005040	1
41	Screw, Cross	8909013	1
42	Gear	5241011	1
43	Screw, Cross	8909008	4
44	Locating Board	6378007	1
45	O-ring	8378123	2
46	Dust Cover	8005034	1
47	Screw, Cross	8902034	1
48	Washer	8952008	1
49	Spring Washer	8953008	1
50	Pick	8152043	1
51	Screw, Cross	8902075	2
52	Control Board	6382025	1
53	Sealing Gasket	8371001	2
54	Fitting Nut	8092034	1
55	O-ring	8378155	2
56	Anti-friction Washer	8216013	1
57	Shaft	5258006	1
58	Moving Disk	8459034	1
59	Fixed Disk	8469050	1
60	Seal Ring	8370054	1
61	Tube	8457039	1
62	Hexagonal Nut	8940001	1
63	Filter Screen	8336008	1
64	Connector	8458068	1
65	Animated Connector	8945025	1
66	O-ring	8378169	1
67	Connector	8458064	1
68	Brine Line Flow Control	8468055	1
69	O-ring	8378179	1
70	Drain Line Flow Control	8468063	1
71	Clip	8270010	1

41206AL Bypass structure and part no.:

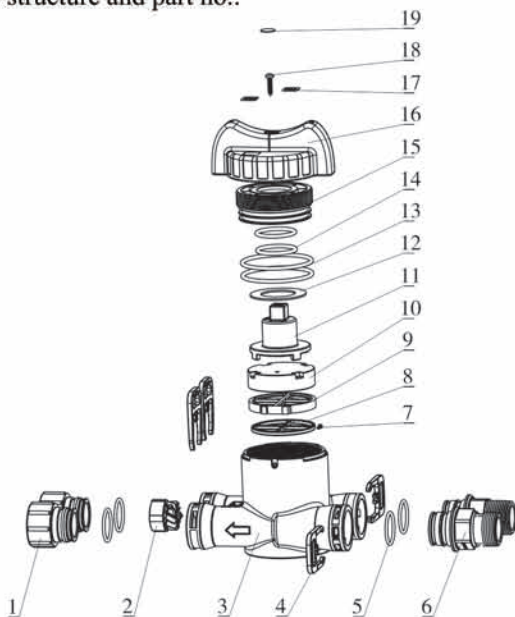

Item No.	Description	Part no.	Quantity
1	Animated Connector	8945001	2
2	Turbine	5295003	1
3	Valve Body	8022180	1
4	Clip	8270004	4
5	O-ring	8378081	4
6	NPT Connector	8458065	2
7	Screw, Cross	8909005	2
8	Seal Ring	8370091	1
9	Fixed Disk	8469061	1
10	Moving Disk	8459061	1
11	Shaft	8258034	1
12	Anti-friction Washer	8216011	1
13	O-ring	8378111	2
14	O-ring	8378195	2
15	Fitting Nut	8092011	1
16	Wheel Handle	8253061	1
17	Label	8869035	2
18	Screw, Cross	8909003	1
19	Label	8860024	1

5447018 Flow meter structure and part no.:

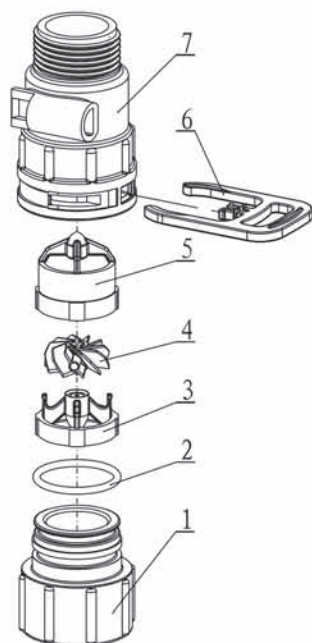

Item No.	Description	Part no.	Quantity
1	Animated Connector	8945001	1
2	O-ring	8378081	1
3	Impeller	5115022	1
4	Turbine	5436010	1
5	Impeller	5115021	1
6	Clip	8270004	1
7	Cover	8002001	1

4. Warranty Card

Dear client:

This warranty card is the guarantee proof of RUNXIN brand multi-functional flow control valve. It is kept by client self. You could get the after-sales services from the supplier which is appointed by RUNXIN manufacturer. Please keep it properly. It couldn't be retrieved if lost. It couldn't be repaired free of charge under the below conditions:

1. Guarantee period expired.(One year);
2. Damage resulting from using, maintenance, and keeping that are not in accordance with the instruction;
3. Damage resulting from repairing not by the appointed maintenance personnel;
4. Content in guarantee proof is unconfirmed with the label on the real good or be altered;
5. Damage resulting from force majeure.

Product Name	 Multi-functional Flow Control Valve for Water Treatment Systems				
Model		Code of Valve Body			
Purchase Company Name			Tel/Cel.		
Problem					
Solution					
Date of Repairing		Date of Accomplishment		Maintenance Man Signature	

When product needs warranty service, please fill in the below content and send this card together with the product to the appointed suppliers or Runxin company.

End-user Company Name				Tel/Cel.	
Purchase Company Name				Tel/Cel.	
Model		Code of Valve Body			
Tank Size ϕ	\times	Resin Tank Size	L	Raw Water Hardness	mmol/L
Water Source: Ground-water <input type="checkbox"/> Tap Water <input type="checkbox"/>		Water Treatment Capacity	m^3	Backwash Time	min
Brine & Slow Rinse Time	min	Brine Refill Time	min	Fast Rinse Time	min
Problem Description					



WENZHOU RUNXIN MANUFACTURING MACHINE CO.,LTD

ADD: NO.169, RUNXIN ROAD, SHANFU TOWN, WENZHOU, ZHEJIANG, CHINA.

TEL.:0086-577-88630038, 88576512, 85956057 FAX:0086-577-88633258

E-MAIL: sales@run-xin.com <http://www.run-xin.com>