



Patent NO.:ZL2021206252482

# Multi-functional Flow Control Valve for Swimming Pool System

53524 (F139)

51524 (F139S)

53524B (F139B)

53512C (F138C)

## User Manual



Please read this manual in details  
before using this valve and keep it properly  
in order to consult in the future

0WRX.466.756

Before the valve put into use, please fill in the below content so as to help us to refer in the future.

### Filter System Configuration

Tank Size: Dia. \_\_\_\_\_ mm, Height \_\_\_\_\_ mm;

Refilled Filter Material \_\_\_\_\_ Kg;

Granularity of Filter Material \_\_\_\_\_ mm;

Control Valve Model \_\_\_\_\_; Number \_\_\_\_\_;

Pressure of Inlet Water \_\_\_\_\_ MPa;

Turbidity of Inlet Water \_\_\_\_\_ FTU.

### Parameter Set

Parameter	Unit	Factory Default	Actual Value
Time of Day	h:m	Current Value	
Rinsing Time	/	02:00	
Rinsing Frequency	/	F-00	
Service Days (By Day)	D	10	
Backwash Time	min.	10	
Fast Rinse Time	min.	10	
Valve Address	/	1	

## Catalogue

Notice .....	3
1.Product Overview .....	4
1.1.Main Application & Applicability .....	4
1.2.Product Characteristics .....	4
1.3.Service Condition .....	4
1.4.Product Structure and Technical Parameters .....	5
1.5.Installation .....	8
2.Basic Setting & Usage .....	11
2.1.The Function of PC Board .....	11
2.2.Basic Setting & Usage .....	14
2.3. Usage of Manual Handle .....	16
3.Applications .....	17
3.1.Flow Chart .....	17
3.2.The Function and Connection of PC Board .....	19
A. Remote Handling Connector .....	19
B. RS-485 Communication between PLC and Single Valve .....	20
C. RS-485 Communication among PLC and Multi-Valves .....	20
D. NC Solenoid Valve Connector .....	21
3.3. RS-485 Port .....	21
3.4. Product System Configuration and Flow Rate Curve .....	22
3.5. Trial Running (Take F139A as an example) .....	24
3.6. Trouble-shooting .....	26
3.7. Assembly & Parts .....	28
4.Warranty Card .....	35

## Notice

- To ensure normal operation of the product, please consult with professional installation or repairing personnel before use it.
- If there are any of pipeline engineering and electric works, there must be finished by professional at the time of installation.
- Do not use the control valve with the water that is unsafe or unknown quality.
- Depending on the changing of working environment and water requirement, each parameter of filtration should be adjusted accordingly.
- Test water periodically to verify that system is performing satisfactorily.
- Do not put the valve near the hot resource, high humidity, corrosive, intense magnetic field or intense vibrations environment. And do not leave it outside.
- Forbidden to use the drain pipe or other connectors as support to carry the system.
- Please use this product under the water temperature between 5~50°C, water pressure < 0.25MPa. Failure to use this product under such conditions voids the warranty.
- If the water pressure exceeds 0.25MPa, a pressure reducing valve must be installed in front of the water inlet.
- It is suggested to install PPR pipe, corrugated pipe or UPVC pipe, instead of TTLSG pipe.
- Do not let children touch or play, because careless operation may cause the procedure changed.
- When the attached cables or transformer of this product are broken, they must be changed to the one that is from our factory.
- Regularly check the filter material, it needs to be added in time if loss.

## 1. Product Overview

### 1.1. Main Application & Applicability

Used for swimming pool filtration equipment.

### 1.2. Product Characteristics

#### ● Simple structure and reliable sealing

It adopts hermetic head faces with high degree pottery and corrosion resistance for opening and closing. It combines with Filter, Backwash, Rinse, Waste, Recirculation and Closed.



#### ● Manual function

Under unlock status, realize rinsing immediately by pressing  at any time.

#### ● Long outage indicator

If outage overrides 3 days, the time of day indicator "12:12" will flash to remind people to reset new time of day. The other parameters do not need to be reset. The process will continue to work after powering on.

#### ● Buttons lock

No operations to buttons on the controller within 1 minute, button lock indicator lights on which represents buttons are locked. Before operation, press and hold the  and  buttons for 5 seconds to unlock. This function can avoid incorrect operation.

#### ● Remote handling connector

This connector can receive external signal and control the valve remotely. (The wiring refers to Figure 3-2)

#### ● RS-485 port

RS-485 port is a remote communication connector to realize remote collection and control of the on-site data of the control valve. It can operate the control valve remotely matched with the upper computer such as PLC. (Application refers to Figure 3-3)

#### ● All parameters can be modified

According to the water quality and usage, the parameters in the process can be adjusted.

#### ● The service days can be set

Under the situation of service reaching the setting days and the pressure not yet, it could enter into rinsing process when current time is the same as rinsing time.

### 1.3. Service Condition

This control valve should be used under the below condition.

	Item	Requirement
Working conditions	Water pressure	< 0.25MPa
	Water temperature	5°C ~ 50°C

Working environment	Environment temperature	5℃ ~ 50℃
	Relative humidity	≤95% ( 25℃ )
	Electrical facility	AC100 ~ 240V/50 ~ 60Hz
Inlet water quality	Water turbidity	< 20FTU

● When the water turbidity exceeds the conditions, the impurity in the inlet water should be coagulated and precipitated firstly.

#### 1.4. Product Structure and Technical Parameters

A.Dimension (The appearance is just for reference. It is subjected to the real product)

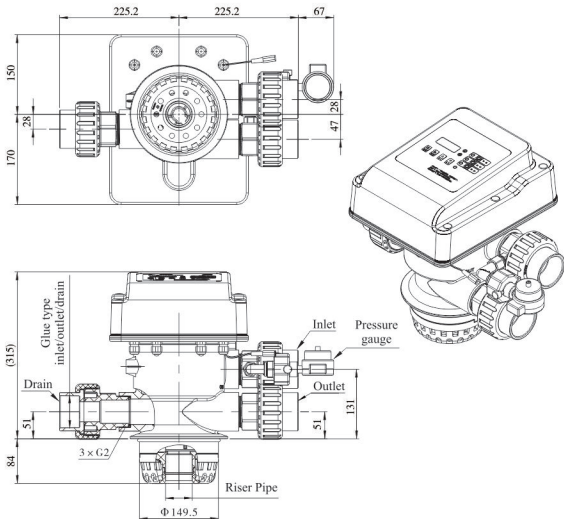

F139A Structure chart

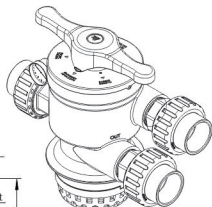
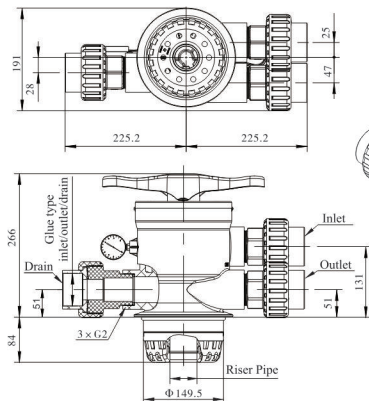

F139AS Structure chart

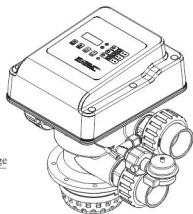
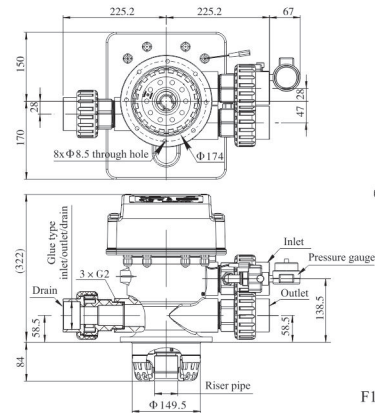

F139B Structure chart

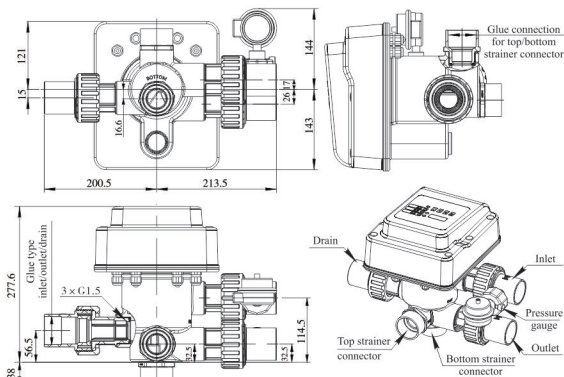

F138C Structure chart

## B. Technical parameter

The suitable transformer output of control valve: DC24V, 1.5A.

Model	Connection Size			Backwash Flow Rate m <sup>3</sup> /h @0.1MPa	Remark	
	Glue Connection for Inlet/Outlet/Drain	Glue connection for top/bottom strainer connector	Base			Riser Pipe
F139A	2"D-GB (OD:63.3 mm UPVC pipe) or 2.375"OD (OD:60.3mm UPVC pipe)	/	Clamp (Suitable for tank internal diameter with 150mm)	1.5"D-GB (OD:50mm) or 1.9"OD (OD: 48.3mm)	24	Top-mounted installation, pressure or time to initiate backwash
F139AS						Top-mounted installation, manual
F139B			Flange connection, 8pcs M8 screw bolts, and the center distance is 174mm. (suitable for tank diameter with 150mm)			Top-mounted installation, pressure or time to initiate backwash
F138C	1.5"D-GB (OD:50mm UPVC pipe)	1.5"D-GB (OD:50mm UPVC pipe)	/	/	12	Side-mounted installation, pressure or time to initiate backwash



**Remark:**

For F139A, F139AS and F139B, there are two types of riser pipe: Chinese Standard 1.5"D-GB and American Standard 1.9"OD.

There are two types of glue connection for Inlet/Outlet/Drain: Chinese Standard 2"D-GB and US Standard 2.375"OD. The factory default is Chinese Standard 2"D-GB. If you need others, please specify when ordering.

**1.5. Installation**

**A.Installation notice**

Before installation, read all those instructions completely. Then obtain all materials and tools needed for installation.

The installation of product, pipes and circuits, should be accomplished by professional to ensure the product can operate normally.

Perform installation according to the relative pipeline regulations and the specification of Water Inlet, Water Outlet, Drain, and Drain Connector.

**B.Device location**

- ①The filter should be located closely to drain.
- ②Ensure the unit is installed in enough space for operating and maintenance.
- ③The unit should be kept away from the heater, and not be exposed outdoor. Sunshine or rain will cause the system damage.
- ④Please avoid installing the system in one acid/alkaline, magnetic or strong vibration circumstance, because above factors will cause the system disorder.
- ⑤Do not install the device, drain pipeline in circumstance which temperature may drop below 5℃, or above 50℃.
- ⑥Install the system in the place where with minimum loss in case of water leaking.

**C. Pipeline installation, take F139A as example**

①Install control valve

- a. As the Figure 1-1 shows, glue the riser pipe and bottom strainer. Put it into the bottom of the tank, and then assemble the bottom strainer. The size from the mouth of the tank to the surface "A" end of the riser pipe is 42-52mm, and cut off excess riser pipe and round it.
- b. Fill the filter material to the tank.
- c. As the Figure 1-2 shows, slowly insert the top strainer into the riser pipe, and then install the control valve on the tank. Then install the clamp and the inlet, outlet, and drain connectors.

**Note:**

- Avoid filling floccules substance together with filter material to the mineral tank.
- Avoid O-ring of the base and riser pipe falling out while installing control valve.

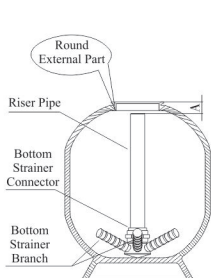

Figure 1-1

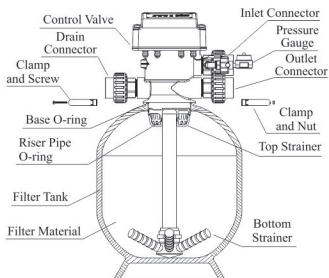

Figure 1-2

② As the Figure 1-3 shows, installation of Outlet/Inlet/Drain Pipeline.

- a. Water pump should be installed at the inlet, and filter net should be installed in front of the water pump.
- b. The back end of the outlet pipeline can be connected to "other system", such as heating systems, disinfection systems, and so on.
- c. The drain pipeline is connected to the sewer, and there must be a certain gap between them.

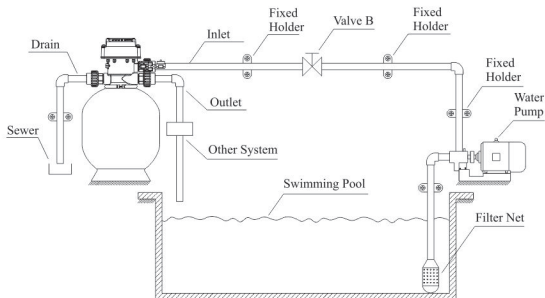

Figure 1-3

**Note:**

- When installing, make sure that each pipeline is horizontal and vertical, and must be supported and fixed with a fixed holder.
- When turning threaded pipe fittings onto plastic fitting, use care not to cross thread or broken valve.
- Control valve should be higher than drain outlet, and be better not far from the drain hose.
- For detailed pipeline installation and connection with "other system", please follow the recommendations of the complete equipment supplier!

**Appendix:** F138C side-mounted control valve after installation, as shown in Figure 1-4:

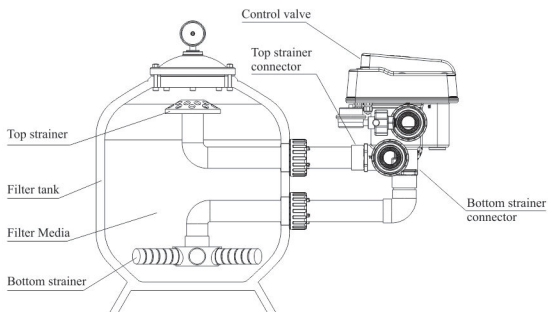
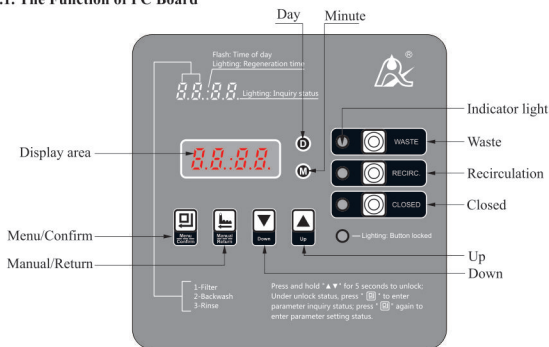

Figure 1-4

## 2. Basic Setting & Usage

### 2.1. The Function of PC Board



#### ① Process Display

When the power is on, the digital tube and all the indicators are displayed, and then the model "F139" is displayed, and it enters the working status after a few seconds.

#### ② Filter status display

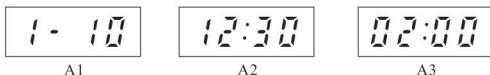

In filter status, the A1, A2 and A3 interfaces are displayed separately for 15 seconds, and then displayed in a loop.

- A1 is the interface of remaining days in the filter status, and 10 in 1-10 means there are 10 remaining service days. The day indicator  lights on and the other indicators light off.
- A2 is time of day display interface of the filter status, and 12:30 means that the current time is 12:30, ":" flashes.
- A3 is the display interface of the rinsing time, means rinsing time is 02:00, ":" is always displayed.

**Operations of switching to other status operation under filter status.**

- In filter status, valve will switch from the filter status to the backwash status if it receives the pressure passive switch signal is closed and the signal duration is longer than or equal to 1 minute.
- In the unlocked filter status, press the manual button to switch the valve from the filter status to the backwash status.
- In the unlocked filter status, press the manual button to switch the valve from service status to waste status.
- In the unlocked filter status, press the manual button to switch the valve from the filter status to the recirculation status.
- In the unlocked filter status, press the manual button to switch the valve from the filter status to the closed status.

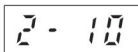
**③ Backwash status display**

B1

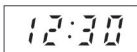

B2

In backwash status, the B1 and B2 interfaces will be displayed separately for 15 seconds, and then displayed in a loop.

- B1 is the display interface for remaining minutes at the backwash status, and 10 in 2-10 means there are remaining 10 minutes at the backwash status. The minute indicator  lights on and other indicators lights off.
- B2 is time of day display interface of the backwash status, and 12:30 means that the current time is 12:30, ":" flashes.

**Operations of switching to rinse status under backwash status**

In the unlocked backwash status, shortly press the manual button to switch from the backwash status to the rinse status.

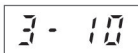
**④ Display of rinse status**

C1

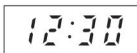

C2

In the rinse status, the C1 and C2 interfaces will be displayed separately for 15 seconds, and then displayed in a loop.

- C1 is the display interface for remaining minutes at rinse status, and 10 in 3-10 means there are 10 minutes left at the rinse status. The minute indicator  lights on and the other indicators lights off.

b) C2 is the current time display interface of rinse status, and 12:30 means that the current time. ":" flashes.

**Operations of switching to filter status under rinse status**

In the unlocked rinse status, press the manual button to switch from the rinse status to the filter status.

Working process:

Filter→Backwash→Rinse→Filter

**⑤ Display of waste status**

a) The four digitals of nixie tube at waste status displays the current time interface. ":" flashes.

b) Waste indicator lights on and the other indicators light off.

c) Switch from other status to the waste status, the four digitals of nixie tube display the D2 interface when the motor rotates, and the waste indicator flashes before reaching waste status. When the waste status is reached, the waste indicator lights on, other indicators lights off.

**Operations of switching to other status under waste status.**

a) In the unlocked waste status, press the manual button to switch from the waste status to the filter status.

b) In the unlocked waste status, press the recirculation button to switch the valve from the waste status to the recirculation status.

c) In the unlocked waste status, press the closed button to switch the valve from the waste status to the closed status.

**⑥ Display of recirculation status**

a) The four digitals of nixie tube at the recirculation status displays the current time interface. ":" flashes.

b) Recirculation indicator lights on and the other indicators light off.

c) Switch from other status to the recirculation status, the four digitals of nixie tube display the D2 interface when the motor rotates, and the recirculation indicator flashes before reaching the recirculation status. When the recirculation status is reached, the recirculation indicator lights on, other indicators light off.

**Switch to other status operation under recirculation status.**

a) In the unlocked recirculation status, press the manual button to switch from the recirculation to the filter status.

- b) In the unlocked recirculation status, press the waste button to switch the valve from the recirculation status to the waste status.
- c) In the unlocked recirculation status, press the closed button to switch the valve from the recirculation status to the closed status.

### ⑦ Display of closed status

- a) The four digitals of nixie tube at the closed status displays the current time interface. ":" flashes.
- b) Closed indicator lights on and the other indicators light off.
- C) Switch from other status to the closed status, the four digitals of nixie tube display the D2 interface when the motor rotates, and the closed indicator flashes before reaching the closed status. When the closed is reached, the closed indicator lights on, other indicators light off.

### Operations of switching to other status operation under closed status.

- a) In the unlocked closed status, press the manual button to switch from the closed to the filter status.
- b) In the unlocked closed status, press the waste button to switch the valve from the closed status to the waste status.
- c) In the unlocked closed status, press the closed button to switch the valve from the closed status to the recirculation status.

### ⑧ Display of the motor rotating

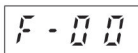

D1

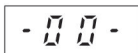



















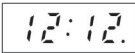

















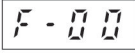







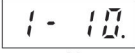



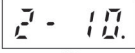

D2

Switching to backwash status under filter status or from finse to filter, display D1 when the motor is rotating; from other status switch to next status, display D2 when the motor is rotating.







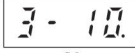

## 2.2. Parameter setting

When the button lock indicator lights on, press and hold ▼ and ▲ for 5 seconds to unlock, and then press [Enter] to enter program inquiry mode. Press ▼ or ▲ to inquiry corresponding parameters according to the following sequence (press [Esc] to exit program inquiry mode).









In program inquiry mode, press [Enter] to enter program set mode.

Item	Process steps	Symbol
Time of Day	<p>When time of day "12:12" flashes continuously, it reminds to reset. Under unlock state:</p> <ol style="list-style-type: none"> <li>1. Press  to enter time of day inquiry as Figure S1 shows, then press  to enter time of day set mode, the hour value flashes, press  or  to adjust the time of day hour value.</li> <li>2. Press  again, the minute value flashes, press  or  to adjust the time of day minute value.</li> <li>3. Press , then finish adjustment, then press  to turn back.</li> </ol>	 <p style="text-align: center;">S1</p>
Rinsing Time	<ol style="list-style-type: none"> <li>1. In program inquiry mode, press  or  to select rinsing time inquiry as Figure S2 shows, and it displays "02:00". Press  to enter the rinsing time set mode, the default 02 hour value flashes, press  or  to adjust the rinsing time hour value.</li> <li>2. Press  again, the default 00 minute value flashes, press  or  to adjust the rinsing time minute value.</li> <li>3. Press , then finish adjustment, then press  to turn back.</li> </ol>	 <p style="text-align: center;">S2</p>
Rinsing Frequency	<ol style="list-style-type: none"> <li>1. In program inquiry mode, press  or  to select rinsing frequency inquiry as Figure S3 shows, and it displays "F-00". Press  to enter the rinsing frequency set mode, the default 00 flashes, press  or  to adjust the rinsing frequency value.</li> <li>2. Press  and hear a sound "Di", then finish adjustment, press  to turn back.</li> </ol>	 <p style="text-align: center;">S3</p>
Service Days	<ol style="list-style-type: none"> <li>1. In the program inquiry mode, press  or  to select the filter days inquiry as Figure S4 shows, and "1-10" is displayed. Press  to enter filter days set status, the default 10 flashes.</li> <li>2. Press  or  to adjust filter days;</li> <li>3. Press , then finish adjustment, then press  to turn back.</li> </ol>	 <p style="text-align: center;">S4</p>
Backwash Time	<ol style="list-style-type: none"> <li>1. In the program inquiry mode, press  or  to select the backwash time inquiry as Figure S5 shows, and "2-10" is displayed. Press  to enter the backwash time set mode, the default 10 flashes.</li> <li>2. Press  or  to adjust backwash time.</li> <li>3. Press , then finish adjustment, then press  to turn back.</li> </ol>	 <p style="text-align: center;">S5</p>
Rinse Time	<ol style="list-style-type: none"> <li>1. In the program inquiry mode, press  or  to select the rinse time inquiry as Figure S6 shows, and "3-10" is displayed. Press  to enter rinse time set mode, the default 10 flashes.</li> <li>2. Press  or  to adjust the rinse time.</li> <li>3. Press , then finish adjustment, then press  to turn back.</li> </ol>	 <p style="text-align: center;">S6</p>



Valve Address	1. In the program inquiry mode, press  or  to select the valve address inquiry as Figure S7 shows, and "1" is displayed. Press  to enter valve address set mode, the default slave valve address 1 flashes. 2. Press  or  to adjust the valve address. 3. Press  , then finish adjustment, then press  to turn back.	 S7
---------------	---	---

For example, backwash time of a filter valve is 10 minutes. After each rinsing, if the turbidity of outlet water is higher than normal at the beginning of filter status, indicating that there is not enough time for backwash. It needs to lengthen the backwash time to 15 minutes, the modification steps as follows:

- ① Press and hold  and  to unlock the button (the buttons lock indicator lights off).
- ② Press  key, the last decimal point of the four digitals of nixie tube lights on.
- ③ Press  or  continuously until the four digitals of nixie tube displays "2-10", and M indicator lights on.
- ④ Press , 10 flashes.
- ⑤ Press  continuously until 10 is changed to 15.
- ⑥ Press the  again, there is a sound "Di" and the number will stop flashing, and program back to enquiry status.
- ⑦ If you want to modify other parameters, you can repeat the steps from 3 to 6; if you don't, press the  key and quit from the inquiry status, the display will show the current service status.

### 2.3. Usage of Manual Handle

During operation of manual control valve F139AS, rotate the manual handle to make the pointer point to the relevant position to realize Filter, Backwash, Rinse, Waste, Recirculation and Closed as below figure.

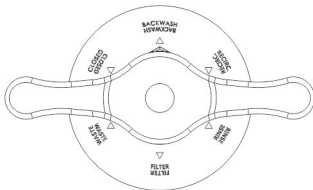

## Meanings of Figures on F139AS Decorative Cover

English	Description
FILTER	Filter Status
BACKWASH	Backwash Status
RINSE	Rinse Status
WASTE	Waste Status
RECIRC.	Recirculation Status
CLOSED	Closed Status

### 3. Applications

#### 3.1. Filter Flow Chart

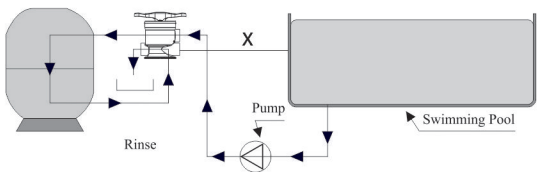
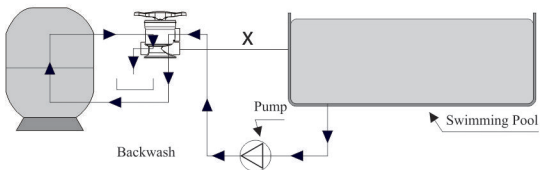
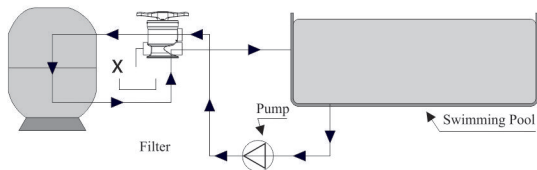

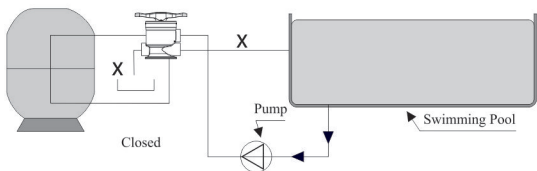
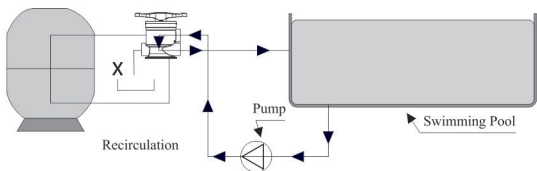
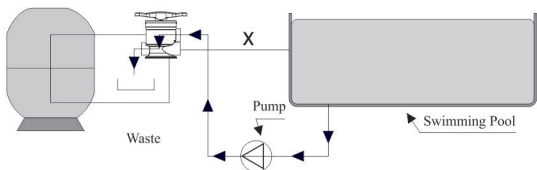

### 3.2.The Function and Connection of PC Board

Open the front cover of control valve, you will see the main control board and connection port as below Figure 3-1:

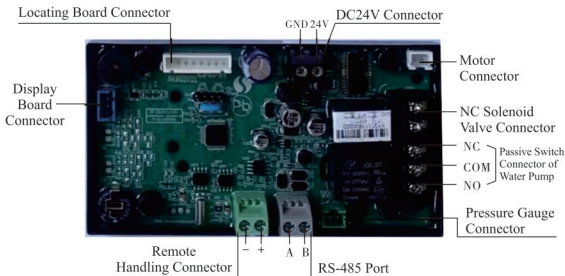

Figure 3-1

#### A.Remote Handling Connector

When the system needs to be rinsed, it can rinse immediately through remote control port on the main board. After receiving the signal, this port is equivalent to pressing the manual button. The wiring is as below Figure 3-2:



Figure 3-2 Wiring of Remote Handling Connector

**B. RS-485 Communication between PLC and Single Valve**

RS-485 communication between PLC and single valve. The wiring refers to Figure 3-3.

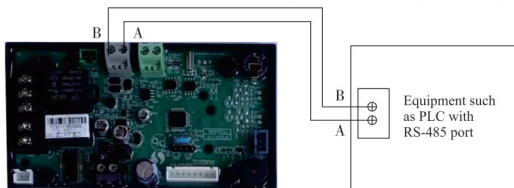

Figure 3-3

**Instruction:**

- 1) Control valve's RS-485 port A and B are respectively connected to PLC's RS-485 port A and B.
- 2) Use twisted pair cables for connection.
- 3) In case of far communication distance, a  $120\Omega/4W$  resistor should be connected in parallel to A and B terminals of PLC and valve.
- 4) Keep away from the high voltage cable when wiring the RS-485 communication cable, and do not bundle the high voltage power cable with RS-485 communication cable together.
- 5) As control valve is matched in system, its address range is 1~247 and the default address is 1. Reading or writing data of control valve from PLC should correspond to the number of valve.

**C. RS-485 Communication among PLC and Multi-Valves**

RS-485 communication among PLC and multi-valves. The wiring refers to Figure 3-4.

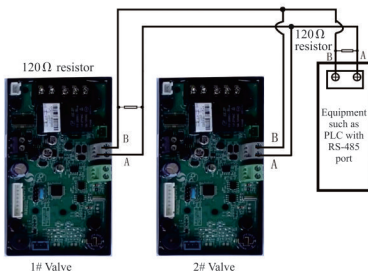

Figure 3-4

**Instruction:**

- 1) RS-485 port A and B of PLC are respectively connected to RS-485 port A and B of 1# valve. It is as the main wire. Port A and B of 2# valves and other valves are directly connected to A and B main wire in parallel.
- 2) In case of far communication distance, a 120Ω1/4W resistor should be connected in parallel to RS-485 port A and B of PLC as well as port A and B of 1# valve. There is no required to connect resistor for port A and B of 2# and other valves.
- 3) RS-485 main communication wire can be connected with 32 sets of RS-485 valves or equipment at most. If connecting more RS-485 valves, a 485 repeater should be connected to the main communication wire.
- 4) As control valve is matched in system, its address range is 1~247 and the default address is 1. Reading or writing data of control valve from PLC should correspond to the number of valve.

**D. NC Solenoid Valve Connector**

NC solenoid valve connector receives passive signal, which connects the positive pole or GND of the external DC normal closed solenoid valve. When control valve is in the backwash, rinse, motor rotation and waste positions, the water inlet is connected with water outlet. If there is water at inlet and the system is powered off, water will always be discharged from the water outlet during backwash, rinse, motor rotation and waste. This will cause waste of water resources. The solenoid valve connector is designed to prevent this phenomenon.

**3.3. RS-485 Port**

**A. RS-485 communication protocol**

- 1) 485 communication protocol: It adopts international MODBUS RTU.
- 2) Information transmission: Half-duplex mode, in bytes.
- 3) Transmission speed: fixed 9600bps baud rate.
- 4) Byte format: 1 start bit, 8 data bits, 1 stop bit, no parity bit. The start bit is 0 and the stop bit is 1.

**B. Read control valve on-site data (0x03)**

The equipment such as PLC is the master, the valve is the slave, the data of slave valve can be read from PLC.

The valve MODBUS communication address and corresponding data are defined as follows:

MODBU Address	Instruction	Unit	Data Definition	Comment
0x2002	Remaining Time	Day/ Minute	0 ~ 99	Read remaining day / minute
0x2005	Fault Status	/	0x0000: Normal 0x0001: E1 0x0002: E2 0x0003: E3 0x0004: E4	Read valve status
0x2007	Current Status	/	0x0001: Filter 0x0003: Backwash 0x0007: Rinse 0x0009: Waste 0x000A: Recirculation 0x000B: Closed 0x0010: Switching	Read the current status of valve
0x2009	Rinsing Time	Hour	0 ~ 23	Read rinsing time, set hour value
0x200A	Rinsing Time	Minute	0 ~ 59	Read rinsing time, set minute value

### C. Write Data for Valve(0x10)

The equipment such as PLC is the master, the valve is the slave, PLC can write the data of slave valve.

MODBU Address	Instruction	Unit	Data Definition	Comment
0x3018	Switch working position	/	0~1 Variation	Filter, backwash, rinse status switching, forced rinsing

## 3.4. Product System Configuration and Flow Rate Curve

### A.Product Configuration

Product configuration with tank, filter material:

Tank Size	Weight of Filter Material	Sand Filter	
		Filtering Flow Rate	Backwash Flow Rate
mm	kg	m <sup>3</sup> /h	m <sup>3</sup> /h
φ 700	210	19	20
φ 635	155	16	17
φ 534	85	12	12
φ 454	40	8	8
φ 410	30	6	7

**Remark:**

●When configuring tanks with different diameters, it need to control the flow rate of filtering and backwash. The specific values are shown in the above table. A flow control can be added on the water outlet for "Filtering Flow Rate", and add a flow control at the drain for "Backwash Flow Control".

●If the flow rate of backwash exceeds the value specified by the corresponding tank, the filter material (quartz sand) will be rushed from the tank, and then flow out from the drain port!

**B.Flow Rate Characteristics**

1). F139 Pressure-flow rate curve

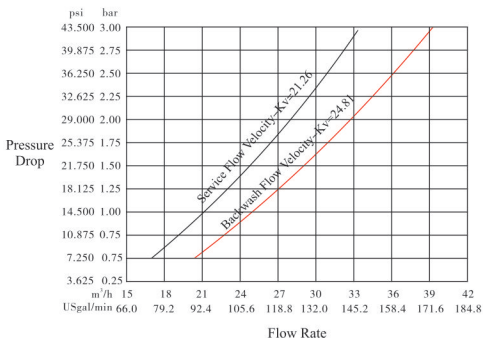



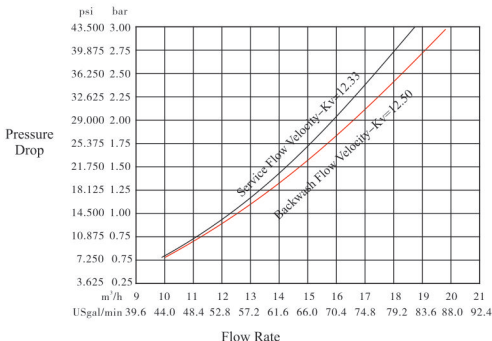

## 2). F138 Pressure-flow rate curve





## 3.5.Trial Running (Take F139A as an example)

① After power on and setting up relevant parameters of the control valve, please conduct the trial running as follows:

A. Press  and enter into Backwash position, and slowly open the inlet "valve B" as "Figure 1-3" shows to the 1/4 position, making the water flows into the tank. You can hear the sound of air-out from the drain pipeline. After all air is out of pipeline, then open inlet "valve B" completely and clean the filter materials in the tank until the outlet water is clean (It can be observed from the transparent joint of the drain). It will take 8~10 minutes to finish the whole process.

B. Press , turning the position from Backwash to Rinse, It will take 10~15 minutes to finish the whole process.

C. Take out some outlet water for testing: if the water reaches the requirement, press  to finish the Rinse; then the control valve will turn to Filter Status.

**Note:** In the process of rinsing, the program will be finished automatically in accordance with the setting time; press , it can end one step in advance and proceed to the next step.

**Note:**

- If water inflows too fast, the filter material in tank will be damaged. When water inflows slowly, there is a sound of air emptying from drain pipeline.
- After changing the filter materials, please operate from steps A to C.
- In the process of trial running, please check the water situation in all position, and ensure there is no filter materials leakage.
- The time for Backwash and Rinse can be set and executed according to the suggestions from the control valve suppliers.

② The function and significance of the main components of the pressure gauge:

Name	Function	Remark
Black pointer	The actual pressure reading of the control valve.	
Red pointer	The upper limit pressure value. When the pressure value of the "black pointer" exceeds the red pointer for 1 minute, the control valve will immediately switch from the filter status to the rinse status.	F139AS does not have this function.
Adjustment knob	It can be used to adjust the value of the "red pointer".	
Green pointer	This valve does not have this function.	
Junction box	The pressure value is fed back to the control board of valve through the lead wire.	

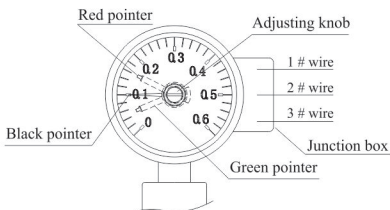

Schematic diagram of pressure gauge

For example, for the first time to load quartz sand or change sand, after steps A to C, the black pointer reads 0.1MPa. If adjust the red pointer to 0.16MPa as shown in above figure, when the tank is in the filter status for a long time, and the quartz sand is too dirty, the pressure of filter tank increases to 0.18-0.20MPa (over 0.02-0.04MPa of the red pointer) and lasts for 1 minute. The pressure gauge will generate a passive switch signal and transmit it to the control valve. At this time, the control valve will immediately turn from the filter status to backwash status, after completing the set time of backwash, it will then switch from the backwash status to the rinse status, finally the valve will turn from rinse status to filter status. At this time, the sand tank pressure is reduced to 0.1MPa (less than 0.16MPa), then the control valve will not receive the "passive switch signal", so the control valve will turn to the filter status to work.

**Note:**

●"Red pointer" value (factory default is 0.2MPa), please readjust according to user needs before use.

●If the users need to change pressure gauge, please pay attention to connect 1# wire and 3# wire from the junction box.

### 3.6. Trouble-shooting

#### A.Control Valve Fault

Problem	Cause	Correction
1.Filter fails to rinse.	A. Pressure gauge sets are broken. B. The rinse time is not set correctly. C. The main board is damaged.	A. Change pressure gauge set. B. Reset time. C. Replace the main board.
2.Filter supplies raw water.	A. Riser pipe leaks. B. Interval valve leaks.	A. Make sure riser pipe and O-ring are not cracked. B. Check or change valve body.
3.Water pressure is lost.	A. Iron is massed in the water supply pipe. B. Iron is massed in the filter.	A. Clean the water supply pipeline. B. Clean valve and add filter materials cleaning chemical, increase frequency of rinsing.
4.Loss of filter materials through drain line.	A. There is air in the system. B. The flow rate of backwash is too big.	A. Assure that well system is dry and has proper air eliminator control. B. Reduce the flow rate of backwash.
5.Control valve cycles continuously.	A. Wire of locating board breaks down. B.The controller is damaged. C. Foreign material stuck the driving gear.	A. Check and connect wire of locating board. B. Replace the controller C. Take out foreign material.

6. Drain flows continuously.	A. Internal valve leaks. B. Electricity fails to supply when the valve is in backwash or rinse status.	A. Check and repair valve body or replace it. B. Turn off bypass valve and restart when power on.
------------------------------	---	--

**B.Controller Part**

<b>Problem</b>	<b>Cause</b>	<b>Correction</b>
1.The nixie tube and indicator light on the display board.	A. Wire between display board and control board is damaged. B.The control board is damaged. C. The power adapter is damp or damaged. D.Electrical service is unstable.	A. Replace wire. B.Replace the control board. C.Check or replace the power adapter D.Check and adjust electrical service.
2.No display on the display board.	A. Wire between display board and control board is damaged. B. Display board is damaged. C.The control board is damaged. D. Electricity is interrupted.	A. Replace wires. B. Replace display board. C. Replace control board. D. Check electricity supply.
3.E1 Flashes.	A.Wire between locating board and control board is damaged. B. Locating board is damaged. C. Motor gear and big gear is damaged. D.The control board is damaged E.Wire between motor and control board is damaged. F. Motor is damaged.	A. Replace wires. B. Replace locating board. C. Check motor gear and big gear. D. Replace control board E.Replace wire between motor and control board. F. Replace the motor
4.E2 Flashes.	A.Hall element of locating board is damaged. B.Wire between locating board and control board is damaged. C.The control board is damaged.	A. Replace the locating board B. Replace wire. C. Replace control board.
5.E3 or E4 Flashes.	A.The control board is damaged.	A.Replace the control board.
6.RS-485 Cannot communicate	A. Wrong wiring of the RS-485. B. The valve address of PLC and other equipment is set incorrectly.	A. Check and reconnect the wire of the RS-485. B. Check and reset the address of PLC and other equipment.

### 3.7.Assembly & Parts

#### F139A/F139B Valve Body Assembly

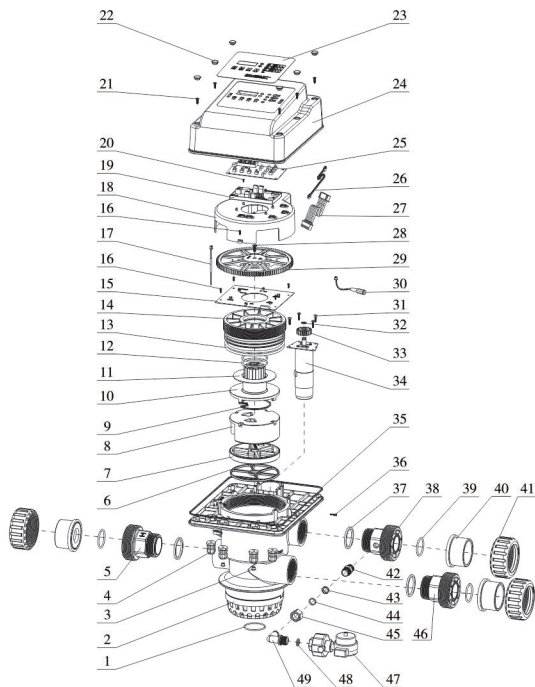

## F139A/F139B Valve Body Components:

Item No.	Description	Part No.	Quantity	Item No.	Description	Part No.	Quantity
1	O-ring 50.47×2.62	8378308	1	21	Screw, Cross ST3.9×16	8909014	6
	O-ring 47.7×3.55	8378124		22	Decorating component	8084027	6
2	F139A-Valve body (Chinese standard)	5022210	1	23	Label (Chinese)	8865198	1
	F139A-Valve body (US standard)	5022210A			Label (English)	8865688	
	F139B-Valve body (Chinese standard)	5022246		24	Dust cover	8005115	1
	F139B-Valve body (US standard)	5022246A		25	Display board	6381075	1
3	Plug	8323032	2	26	Wire for display board	5512001	1
4	Cable gland	5457048	4	27	Wire for loading board	5511005	1
5	Connector (transparent PC)	8458339	1	28	Screw, cross ST4.8×19	8909018	1
6	Seal ring	8370166	1	29	Big gear	8241040	1
7	Fixed disk	8469126	1	30	Wire for power	5513011	1
8	Moving disk	8459116	1	31	Screw, cross ST3.9×16	8909044	4
9	Seal ring	8370018	1	32	Pin	8994009	1
10	Shaft	8258037	1	33	Small gear	8241008	1
11	Anti-friction washer	8216028	1	34	Motor	6158038	1
12	O-ring 59.92×3.53	8378110	2	35	Seal washer	8371114	1
13	O-ring 142.24×5.33	8378245	2	36	Screw, cross ST2.9×16	8909010	2
14	Fitting nut	8092043	1	37	Seal washer	8371008	3
15	Locating board	6380087	1	38	Connector (ABS+GF10)	8458356	1
16	Screw, cross ST2.9×9.5	8909008	7	39	O-ring 41.7×3.5	8378201	3
17	Wire	5516004	1	40	Connector (Chinese standard)	8457071	3
18	Fixed base	8109168	1		Connector (US Standard)	8458305	
19	Control board	6382217	1	41	Animated nut	8947029	3
20	Screw, Cross ST2.2×6.5	8909004	2				

42	Connector	8458365	1	46	Connector	8458318	1
43	Seal ring	8371044	1	47	Pressure gauge	6342003	1
44	Clip	8994029	1	48	Seal ring	8371020	1
45	Nut	8940037	49	Connector	8458366	1	

F139AS Valve Body Assembly:

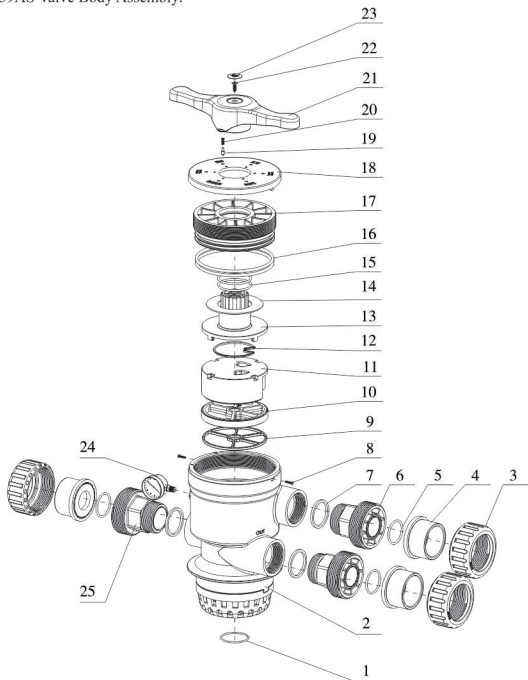

## F139AS Valve Body Components:

Item No.	Description	Part No.	Quantity	Item No.	Description	Part No.	Quantity
1	O-ring 50.47×2.62 Chinese standard	8378308	1	12	Seal washer	8370018	1
	O-ring 47.7×3.55 US standard	8378124		13	Shaft	8258037	1
2	Valve body (Chinese standard)	5022222	1	14	Anti-friction washer	8216028	1
	Valve body (US standard)	5022222A	1	15	O-ring 59.92×3.53	8378110	2
3	Animated nut	8947029	3	16	O-ring 142.24×5.33	8378245	2
4	Connector (Chinese standard)	8457071	3	17	Fitting nut	8092043	1
	Connector (US Standard)	8458305		18	Decorative cover	8444038	1
5	O-ring 41.7×3.5	8378201	3	19	Locating Part	8271012	1
6	Connector (ABS+GF10)	8458318	2	20	Spring	8282002	1
7	Seal washer	8371008	3	21	Manual handle	8253094	1
8	Screw, cross ST2.9×16	8909010	2	22	Screw, Cross ST4.8×19	8909018	11
9	Seal ring	8370166	1	23	Label	8860029	1
10	Fixed disk	8469126	1	24	Pressure gauge	8342001	1
11	Moving disk	8459116	1	25	Connector (transparent PC)	8458339	1



F138C Valve Body Assembly:

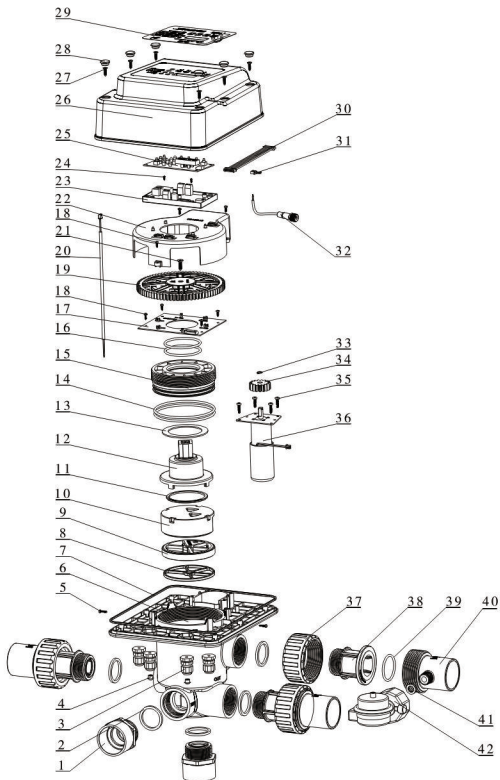

## F138C Valve Body Components:

Item No.	Description	Part No.	Quantity	Item No.	Description	Part No.	Quantity
1	Connector	8458382	2	23	Control board	6382217	1
2	Seal washer	8371030	5	24	Screw, Cross ST2.2×6.5	8909004	1
3	Cable gland	5457048	4	25	Display board	6381083	1
4	Plug	8323032	2	26	Dust cover	8005143	1
5	Screw, Cross ST2.9×13	8909023	2	27	Screw, Cross ST3.9×16	8909014	6
6	Valve body	8022299	1	28	Decorative cover	8084027	6
7	Seal washer	8371124	1	29	Label (Chinese)	8865210	1
8	Seal ring	8370175	1		Label (English)	8865725	1
9	Fixed disk	8469130	1	30	Wire for locating board	5511005	1
10	Moving disk	8459120	1	31	Wire for display board	5512001	1
11	Moving seal ring	8370023	1	32	Wire for power	5513071	1
12	Shaft	8258051	1	33	Pin	8994026	1
13	Anti-friction washer	8216006	1	34	Small gear	8241054	1
14	O-ring 103×3.55	8378130	2	35	Screw, Cross ST3.9×16	8904044	4
15	Fitting nut	8092055	1	36	Motor	6158081	1
16	O-ring 59.92×3.53	8378110	2	37	Animated nut	8947028	3
17	Locating board	6380091	1	38	Connector (ABS+GF10)	8458377	2
18	Screw, Cross ST2.9×9.5	8909008	7		Connector (transparent PC)	8458378	1
19	Big gear	8241068	1	39	O-ring 41.7×3.5	8378201	3
20	Connecting wire	5516004	1	40	Joint	8458379	2
21	Screw, Cross ST4.8×19	8909018	1		Joint (with thread)	8458380	1
22	Fixed base	8109192	1	41	Seal ring	8371020	2
				42	Pressure gauge	6342003	1



## 4. Warranty Card

Dear client:

This warranty card is the guarantee proof of Runxin brand multi-functional flow control valve. It is kept by client self. You could get the after-sales services from the supplier which is appointed by Runxin manufacturer. Please keep it properly. It couldn't be retrieved if lost. It couldn't be repaired free of charge under the below conditions:

1. Guarantee period expired. (One year from the valve manufacturing date);
2. Damage resulting from using, maintenance, and keeping that are not in accordance with the instruction;
3. Damage resulting from repairing not by the appointed maintenance personnel;
4. Content in guarantee proof is unconfirmed with the label on the real good or be altered;
5. Damage resulting from force majeure.

Product Name	 Multi-functional Control Valve for Swimming Pool System		
Model		Code of Valve Body	
Purchase Company Name		Tel/Cel.	
Problem			
Solution			
Date of Repairing		Date of Accomplishment	Maintenance Man Signature

When product needs warranty service, please fill in the below content and send this card together with the product to the appointed suppliers or Runxin company.

End-user Company Name		Tel/Cel.	
Purchase Company Name		Tel/Cel.	
Model		Code of Valve Body	
Tank Size $\phi$	×	Filter Material	kg
			Water Source: Ground-water <input type="checkbox"/> Tap Water <input type="checkbox"/>
Service Time	D	Backwash Time	min
		Rinse Time	min
Problem Description			



---

**WENZHOU RUNXIN MANUFACTURING MACHINE CO.,LTD**

ADD: NO.169, RUNXIN ROAD, SHANFU TOWN, WENZHOU, ZHEJIANG, CHINA.

TEL.:0086-577-88630038, 88576512, 85956057 FAX:0086-577-88633258

E-MAIL: [sales@run-xin.com](mailto:sales@run-xin.com) <http://www.run-xin.com>

Rev.A.2210