



International Patent Public No.:  
WO 2006/007772  
US Patent No.: 7549446  
India Patent No.: 232582  
Russia Patent No.:2349819  
South Korea Patent No.:10-0914137  
Mexico Patent No.: 268581  
Australia Patent No.: 2005263257  
Philippine Patent No.: 1-2006-502553  
Taiwan Patent No.:M287896

## Multi-functional Flow Control Valve for Water Treatment Systems

63518(Old Model No.: N77A1)  
63618(Old Model No.: N77A3)  
53518(Old Model No.: N77B1)

## User manual



Please read this manual in details  
before using this valve and keep it properly  
in order to consult in the future

0WRX.466.511

MODEL: 63518-N77A1/63618-N77A3/53518-N77B1

Before the valve put into use, please fill in the below content so as to help us to refer in the future.

**Softener System Configuration**

Tank Size: Dia. \_\_\_\_\_ mm, Height \_\_\_\_\_ mm;

Resin Volume \_\_\_\_\_ L; Brine Tank Capacity \_\_\_\_\_ L;

Hardness of Raw Water \_\_\_\_\_ mmol/L;

Pressure of Inlet Water \_\_\_\_\_ MPa;

Control Valve Model \_\_\_\_\_ ; Number \_\_\_\_\_ ;

The Specification of Drain Line Flow Control \_\_\_\_\_ ;

Injector No. \_\_\_\_\_.

Water Source: Ground-Water  Filtered Ground-water  Tap Water  Other \_\_\_\_\_.

**Parameter Set**

Parameter	Unit	Factory Default	Actual Value
Control Mode A-01 ( 02, 03, 04 )	/	A-01	
Water Treatment Capacity ( Meter type )	m <sup>3</sup>	80	
Service Days ( Time clock type, by days )	D.	03	
Service Hours ( Time clock type, by hours )	H.	20	
Regeneration Time	/	02 : 00	
Backwash Time	min.	10	
Brine & Slow Rinse Time	min.	60	
Brine Refill Time	min.	05	
Fast Rinse Time	min.	10	
Interval Regeneration Days	D	30	
Output Mode b-01 ( 02 )	/	b-01	

● If there is no special requirement when product purchase, we choose 3# drain line flow control and 3# injector for the standard configuration.

## Catalogue

Notice1.....	3
1.Product Overview.....	4
1.1. Main Application & Applicability.....	4
1.2. Product Characteristics.....	4
1.3. Service Condition.....	7
1.4. Product Structure and Technical Parameters.....	8
1.5. Installation.....	9
2.Basic Setting & Usage.....	13
2.1. The Function of PC Board.....	13
2.2. Basic Setting & Usage.....	15
3.Application.....	18
3.1.Working Flow Chart.....	18
3.2.The Function and Connection of PC Board.....	20
A. Signal Output.....	21
B. Interlock.....	24
C. Pressure Relief Output.....	24
D. Remote Handling Input.....	25
E. The Maximum Interval Regeneration Days.....	25
F. Interlock System.....	25
G. Series System.....	25
3.3. System Configuration and Flow Rate Curve.....	26
3.4. Parameter Settlement.....	28
3.5. Parameter Enquiry and Setting.....	29
3.6. Trial Running.....	33
3.7. Trouble-Shooting.....	34
3.8. Spare Part and Part No.....	37
4.Warranty Card.....	41

## Notice

- To ensure normal operation of the valve, please consult with professional installation or repairing personnel before use it.
- If there are any of pipeline engineering and electric works, there must be finished by professional at the time of installation.
- Do not use the control valve with the water that is unsafe or unknown quality.
- Depending on the changing of working environment and water requirement, each parameter of softener should be adjusted accordingly.
- When the water treatment capacity is too low, please check the resin. If the reason is shortage of resin, please add; if the resin is turn to reddish brown or broken, please replace.
- Test water periodically to verify that system is performing satisfactorily.
- Sodium used in the water softening process should be considered as part your overall dietary salt intake. Contact doctor if you are on a low sodium diet.
- Do not put the valve near the hot resource, high humidity, corrosive, intense magnetic field or intense vibrations environment. And do not leave it outside.
- Forbidden to carry the injector body. Avoid to use injector body as support to carry the system.
- Forbidden to use the brine tube or other connectors as support to carry the system.
- Please use this product under the water temperature between 5 ~ 50°C, water pressure 0.2 ~ 0.6MPa. Failure to use this product under such conditions voids the warranty.
- If the water pressure exceeds 0.6Mpa, a pressure reducing valve must be installed before the water inlet. While, if the water pressure under 0.2MPa, a booster pump must be installed before the water inlet.
- It is suggested to install PPR pipe, corrugated pipe or UPVC pipe, instead of TTLSG pipe. Keep the pipeline straight.
- Do not let children touch or play, because carelessness operating may cause the procedured to the one that is from our factory.
- We advise you to use M88 × 2 distributors. It is easy for disassembly.

## 1. Product Overview

### 1.1. Main Application & Applicability

Used for softening, demineralization or filtration water treatment systems N77A (DF for regeneration), suitable for Ion exchange equipment, the raw water hardness  $\leq 6.5\text{mmol/L}$ .

Boiler softening water system

RO pretreatment softening system, etc.

N77B(Filtration), suitable for swimming pool filter system.

Filtration system

Activated carbon filter or sand filter of RO pretreatment system.

### 1.2. Product Characteristics

#### ●Simple structure and reliable sealing

It adopts hermetic head faces with high degree pottery and corrosion resistance for opening and closing. It combines with Service, Backwash, Brine & Slow Rinse, Brine Refill and Fast Rinse.

#### ●Two ways for installation

Use side-mounted connector to change the valve from top-mounted to side-mounted. Screen is moveable.

#### ●No water pass the valve during regeneration in single tank type

#### ●Brine refill controlled by electronic ball valve.

During service, electronic ball valve will control to start the brine refill. In order to short the regeneration cycle time.

#### ●For filtration system

Drain outlet is the same size as water outlet. Block the brine line connector change the valve to N77B filter valve.

#### ●Manual function

Realize regeneration immediately by pushing  at any time.

#### ●Long outage indicator



If outage overrides 3 days, the time of day indicator  will flash to remind people to reset new time of day. The other set parameters do not need to reset. The process will continue to work after power on.

#### ●LED dynamic screen display LED

## MODEL: 63518-N77A1/63618-N77A3/53518-N77B1

The stripe on dynamic screen flash, it indicates the control valve is in service, otherwise, it is in regeneration cycle.

### ● Buttons lock

No operations to buttons on the controller within 1 minute, button lock indicator light on which represent buttons are locked. Before operation press and hold the  and  buttons for 5 seconds to unlock. This function can avoid incorrect operation.

### ● It can choose time clock type or meter type by program selection

Through the switch in control board (Application refer to Page 20) to realize time clock type by day or by hour and meter type. (Attention: after adjust the switch, the valve should be cut off the power then connect again. Meter type valve have one more flow meter and cable then time clock type valve.)

### ● Interlock function

It has a function of interlock to realize only one valve in regeneration but the other valves are in service while several valves parallel in system. In multi-steps treatment systems such as RO pre-treatment, when several valves are in series, there is only one valve in regeneration or washing to ensure pass water all the times. (Application refer to Figure 3-9)

### ● Signal output

There is a signal output connector on main control board. It is for controlling external wiring (Refer to Figure from Figure3-1 to Figure 3-8). There are two kinds of output modes: b-01 Mode: Turn on start of regeneration and shut off end of regeneration; b-02 Mode: Signal available only intervals of each statue.

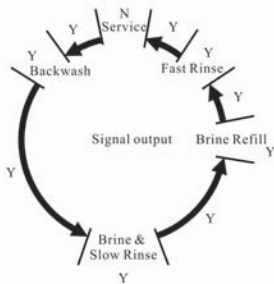

b-01

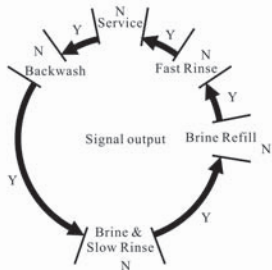

b-02

## MODEL: 63518-N77A1/63618-N77A3/53518-N77B1

### ● Remote handling input

This connector can receive external signal, used together with PLC, and computer etc. to control the valve. (Application refer to Figure3-11)

### ● Pressure relief output

The valve will cut off feeding water to drain line when it switches in regeneration cycles (Same as signal output b-02). Thus in some water treatment system, e.g. Deep Well, one booster pump was installed on the inlet to increase the system water feeding pressure, this cut-off will cause pressure on inlet rising too fast to damage the valve. Pressure Relief Output can be used to avoid this problem. (Application refer to Figure3-10)

### ● All parameters can be modified

According to the water quality and usage, the parameters in the process can be adjusted.

### ● Two kinds of meter type can be selected (suit for N77A3)

Model	Name	Instruction
A-01	Meter Delayed	Regenerate on the day although the available volume of treated water drops to zero (0). Regeneration starts at the regeneration time.
A-02	Meter Immediate	Regenerate immediately when the available volume of treated water drops to zero(0).
A-03	Intelligent Meter Delayed	Meter Delayed Regeneration type, but by setting Resin Volume, Feed Water Hardness, Regeneration Factor, the controller will calculate the System Capacity. Regeneration mode is the same as A-01.
A-04	Intelligent Meter Immediate	Meter Immediately Regeneration Type, but by setting Resin Volume, Feed Water Hardness, Regeneration Factor, the controller will calculate the System Capacity.

### ● Maximum interval regeneration days(Suit for N77A3)

Under the situation of service reaching the setting days and the volume not yet, it could enter into regeneration process forcibly when current time is the same as regeneration time.

### 1.3. Service Condition

Runxin Valve should be used under the below conditions:

	Items	Requirement
Working conditions	Water pressure	0.2MPa ~ 0.6MPa
	Water temperature	5℃ ~ 50℃
Working environment	Environment temperature	5℃ ~ 50℃
	Relative humidity	≤95% ( 25℃ )
	Electrical facility	AC100 ~ 240V/50 ~ 60Hz
Inlet water quality	Water turbidity	Softener(N77A)<5FTU; Filter(N77B)<20FTU
	Water hardness	First Grade Na <sup>+</sup> <6.5mmol/L; Second Grade Na <sup>+</sup> <10mmol/L
	Free chlorine	<0.1mg/L
	Iron <sup>2+</sup>	<0.3mg/L
	CODMn	<2mg/L ( O <sub>2</sub> )

In the above table, First Grade Na<sup>+</sup> represents First Grade Na<sup>+</sup> Exchanger. Second Grade Na<sup>+</sup> represents Second Grade Na<sup>+</sup> Exchanger.

● When the water turbidity exceeds the conditions, a filter should be installed on the inlet of control valve.

● When the water hardness exceeds the conditions, the outlet water hardness will hardly reach the requirement of boiler feed water ( 0.03 mmol/L ) . It is suggested to adopt second grade softener.



## MODEL: 63518-N77A1/63618-N77A3/53518-N77B1

### 1.4. Product Structure and Technical Parameters

A. Product dimension (The appearance is just for reference. It is subjected to the real product.)

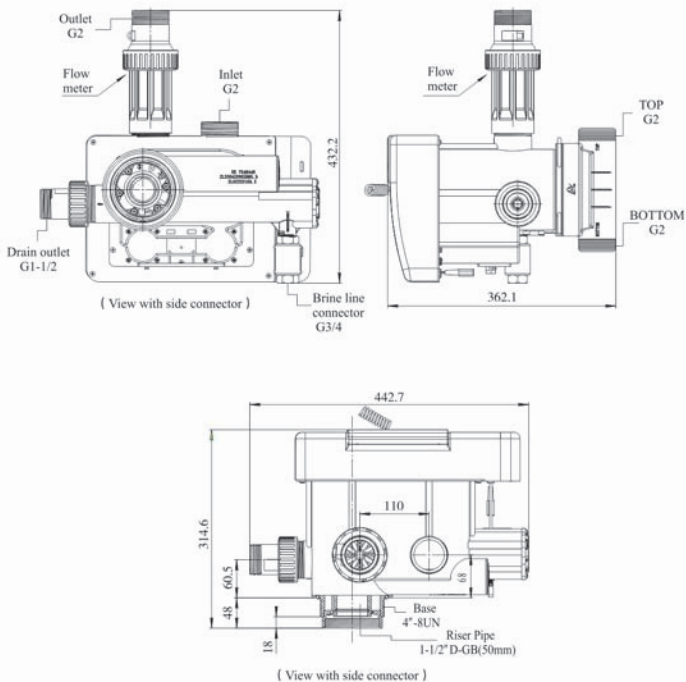

Remove the flow meter from N77A3, it will be N77A1. If block the brine line connector and drain connector of N77A3, it will be N77B.

## MODEL: 63518-N77A1/63618-N77A3/53518-N77B1

### B. Technical Parameter

Transformer Output: DC24V/1.5A

Model	Connector Size					Flow Rate m <sup>3</sup> /h @0.3MPa	Remark
	In/ Outlet	Drain Outlet	Brine Line Co- nector	Base	Riser Pipe		
N77A1	2" M	1.5" M	3/4" M	4-8UN	1.5" OD (50mm)	18	DF softener, by day
N77A2							DF softener, by hour
N77A3							DF softener, meter type
N77B1	2" M	2" M	/	4-8UN	1.5" OD (50mm)	18	Filter, by day
N77B2							Filter, by hour

Remark: M-Male F-Female OD-Outer Diameters, 1.05OD=26.7mm

### 1.5. Installation

Before installation, read all those instructions completely. Then obtain all materials and tools needed for installation.

The installation of product, pipes and circuits, should be accomplished by professional to ensure the product can operate normally.

Perform installation according to the relative pipeline regulations and the specification of Water Inlet, Water Outlet, Drain Outlet, and Brine Line Connector.

#### B. Device location

- ① The filter or softener should be located close to drain.
- ② Ensure the unit is installed in enough space for operating and maintenance.
- ③ Brine tank need to be close to softener.
- ④ The unit should be kept away from the heater, and not be exposed outdoor. Sunshine or rain will cause the system damage.
- ⑤ Please avoid to install the system in one Acid/Alkaline, Magnetic or strong vibration circumstance, because above factors will cause the system disorder.
- ⑥ Do not install the filter or softener, drain pipeline in circumstance which temperature may drop below 5°C, or above 50°C.
- ⑦ One place is recommended to install the system which cause the minimum loss in case of water leaking.

## MODEL: 63518-N77A1/63618-N77A3/53518-N77B1

### C. Pipeline installation (Take N77A top-mounted as a sample)

#### ① Install control valve

a. As the Figure 1-1 shows, select the riser pipe with 50mm OD, glue the riser pipe to the bottom strainer and put it into the mineral tank, cut off the exceeding tube out of tank top opening.

b. Fill the mineral to the tank, and the height is accordance with the design code.

c. Install the top distributor to the valve.

d. Insert the riser tube into control valve and screw tight control valve.

#### Note:

● The length of riser tube should be neither higher 2mm nor lower 5mm than tank top opening height, and its top end should be rounded to avoid damage of O-ring inside the valve.

● Avoid floccules substance together with resin to fill in the mineral tank.

● Avoid O-ring inside control valve falling out while rotating it on the tank.

#### ② Install flow meter

As Figure 1-2 shows, put the sealing ring into nut of flow meter, screw in water outlet; insert the sensor into flow meter.

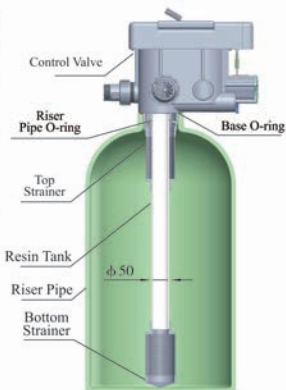

Figure 1-1

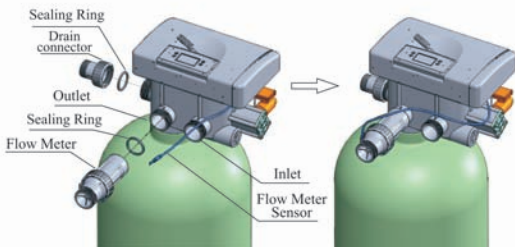

Figure 1-2

③ Pipeline connection

- a. As Figure1-3 shows, install a pressure gauge in water inlet.
- b. Install sampling valves in inlet, outlet and pipeline A.B.C.D as showed in Figure 1-3.
- c. Inlet pipeline should be in parallel with outlet pipeline. Support inlet and outlet pipeline with fixed holder.

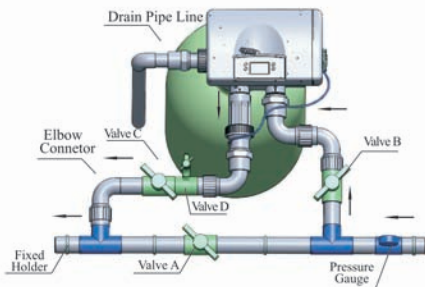

Figure1-3

Note:

- If making a soldered copper installation, do all sweat soldering before connecting pipes to the valve. Torch heat will damage plastic parts.
- When turning threaded pipe fittings onto plastic fitting, use care not to cross thread or broken valve.
- If the valve belongs to time clock type (N77A1、N77B1), there are no step ②.

④ Install drain pipeline (If no special requirement, the standard DLFC is No.7703)

- a. Based on the table P22, for N77A, if tank diameter is 900mm, use thematched DLFC. If the tank size bigger then 900mm, you need to ask supplier for another DLFC which doesn't drill hole. Install it as below steps.
- b. According to matched tank diameter size, to drill  $\phi 6$  hole on the corresponding quantity of DLFC.



Figure1-4

## MODEL: 63518-N77A1/63618-N77A3/53518-N77B1

c. Insert drain line flow control into drain hose connector, then crew it into drain outlet, and lock it.

d. Glue the drain outlet with UPVC (DN40). Put drain outlet pipe to sewer as showed in the Figure 1-4.

e. For filter valve N77B, there is no DLFC, install UPVC (DN40) according to step d.

Note:

● Control valve should be higher than drain outlet, and be better not far from the drain hose.

● Be sure not connect drain with sewer, and leave a certain space between them, avoid wastewater be absorbing to the water treatment equipment, such as showed in the Figure1-4.

### ⑤ Connect brine tube

a. As Figure1-5 shows, use UPVC (DN20) to connect brine valve with brine line connector

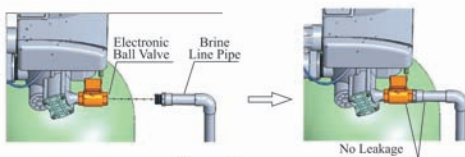

Figure 1-5

Note:

● Keep brine line short and smooth. Elbow no more than four to avoid bad brine.

● Brine valve must be installed.

## 2. Basic Setting & Usage

### 2.1. The Function of PC Board

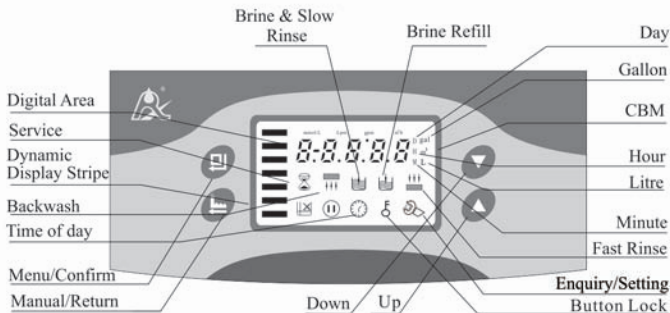

#### A. ⌚ Time of day indicator

● Light on, display the time of day.

● Light flash, remind you to reset the time of day if electrical service interrupted. 3 days more (If electrical service interrupted within 3 days, it doesn't need to reset the time.)

#### B. 🔒 Button lock indicator

● Light on, indicate the buttons are locked. At this moment, press any single button will not work (No operation in one minute, 🔒 will light on and lock the buttons.)

● Solution: Press and hold both ▲ and ▼ for 5 seconds until the 🔒 light off.

#### C. 🔄 Program mode indicator

● Light on, enter program display mode. Use ▲ or ▼ to view all values.

● Flash, enter program set mode. Pressor ▲ to ▼ adjust values.

#### D. 📄 Menu/Confirm button



● Press 📄, light on, enter program display mode and use ▲ or ▼ to view all values.



● In program display mode, press 📄, flash, enter program set mode, press ▲ or ▼ and adjust values.

MODEL: 63518-N77A1/63618-N77A3/53518-N77B1

● Press  after all program are set, and then the voice “Di” means all setting are success and return program display mode.

E.  Manual/Return button

● Press  in any status, it can proceed to next step.(Example: Press  in Service status, it will start regeneration cycles instantly; Press  while it is in Backwash status, it will end backwash and go to Brine & Slow Rinse at once.)

● Press  in program display mode, and it will return in Service; Press  in program set mode, and it will return program display mode.

● Press  while adjusting the value, then it will return program display mode directly without saving value.

F. Down  and Up 







● In program display mode, press  or  to view all values.

● In program set mode, press  or  to adjust values.

● Press and hold both  and  for 5 seconds to unlock.

## 2.2. Basic Setting & Usage

### A. Parameter specification

Function	Indicator	Factory Default	Parameter set range	Instruction
Time of Day		Random	00: 00 ~ 23:59	Set the time of day when use: “ : ” flash.
Control Mode	A-01	A-01	A-01	Regenerate on the day although the available volume of treated water drops to zero (0). Regeneration starts at the regeneration time.
			A-02	Regenerate immediately when the available volume of treated water drops to zero(0).
			A-03	Meter Delayed Regeneration type, but by setting Resin Volume, Feed Water Hardness, Regeneration Factor, the controller will calculate the System Capacity. Regeneration mode same as A-01.
			A-04	Meter Immediately Regeneration Type, but by setting Resin Volume, Feed Water Hardness, Regeneration Factor, the controller will calculate the System Capacity. Regeneration mode same as A-02.
Service Days		1-03D.	0 ~ 99Days	Only for Time Clock Type, regeneration by days
Service Hours		1-20H.	0 ~ 99Hours	Only for Time Clock Type, regeneration by hours
Regeneration Time	02:00	02:00	00: 00 ~ 23:59	Regeneration time; “ : ” light on
Resin Volume	50L	500L	20 ~ 999L	Resin volume in brine tank(L)
Feed Water Hardness	Yd1.2	1.2	0.1 ~ 9.9	Feed water hardness (mmol/L)
Exchange Factor	AL.65	0.65	0.30 ~ 0.99	Relate to the raw water hardness. When hardness is higher, the factor is smaller.
Water Treatment Capacity		80m <sup>3</sup>	0 ~ 999.9m <sup>3</sup>	Water treatment capacity in one circle (m <sup>3</sup> )
Backwash Time		10min.	0 ~ 99	Backwash time(Minute)
Brine & Slow Rinse Time		60min.	0 ~ 99	Brine & Slow rinse time(Minute)
Fast Rinse Time		10min.	0 ~ 99	Fast Rinse Time(Minute)



**MODEL: 63518-N77A1/63618-N77A3/53518-N77B1**

Brine Refill Time		5min.	0 ~ 99	Brine refill time(Minute)
Maximum Interval Regeneration Days	H-30	30	0 ~ 40	Regenerate on the day even through the available volume of treated water do not drop to zero (0).
Output Control Mode	b-01	01	01 or 02	Mode 01: Signal turn on start of regeneration and shut off end of regeneration. (Connection refer to the Figure P5) Mode 02: Signal available only intervals of regeneration cycles and in service. (Connection refer to the Figure P5)

**B. Process Display**



FigureA



FigureB



FigureC



FigureD

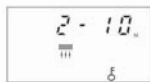

FigureE



FigureF

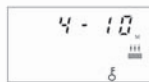

FigureG



FigureH

**Illustration**

- In Service status, the figure shows A/B/C/D; In Backwash status, it shows figure E/C; In Brine& Slow Rinse status, it shows F/C; In Fast Rinse status, it shows figure G/C; In Brine Refill status, it shows figure H/C. In each status, every figure shows 15 seconds.
- Above displays are taking the Meter Type for example. For the Time Clock Type, it shows the rest days or hours, such as 1-03D or 1-10H.
- The time of day figure “-00-” flash continuously, such as “12: 12” flash, indicates long outage of power. It reminds to reset the time of day.
- The display will show the error code, such as “-E1-” when the system is in error.
- Working process: Service→ Backwash→ Brine & Slow Rinse→ Brine Refill→ Fast Rinse→ Service.













### C. Usage

After being accomplished installation, parameter setting and trial running, the valve could be put into use. In order to ensure the quality of outlet water can reach the requirement, the user should complete the below works:













①Ensure that there is solid salt all the time in the brine tank in the course of using when this valve is used for softening. The brine tank should be added the clean water softening salts only, at least 99.5% pure, forbidding use the small salt and iodized salt.

②Test the outlet water and raw water hardness at regular time. When the outlet water hardness is unqualified, please press the  and the valve will temporary regenerate again (It will not affect the original set operation cycle.)

③When the feed water hardness change a lot, you can adjust the water treatment capacity as follow:

Press and hold both  and  for 5 seconds to lift the lock status. Press , and the  light on, then press , the digital area show the control mode. If it shows A-01 or A-02, press  three times, and the digital area will show the given water treatment capacity( If the control mode shows A-03 or A-04, then press  four times, the digital area will show the feed water hardness); Press  again,  and digital flash. Press  or  continuously, reset the capacity value (Or water hardness). Press  and hear a sound "Di", then finish the adjustment. Press  exit and turn back the service status.

The estimation of water treatment capacity, you can refer to the professional application specification. When select A-03 or A-04 intelligent control mode, the control will automatically calculate the water treatment capacity by setting resin volume, feed water hardness and regeneration factor.

④For A-01 or A-03 control mode (Delayed regeneration type), please pay attention to whether the time is current or not. If the time is not right, you can adjust as follow: After lifting the lock status, press , the  and  light on. Then press , the  and hour value flashes. Press  or  continuously, reset the hour value; Press  again,  and minute value flash. Press  or  continuously, reset the minute value; Press  and hear a sound "Di", then finish the adjustment. Press  exit and turn back the service status.

The regeneration parameters have been set when control valve left factory. Generally, it does not need to reset. If you want enquiry and modify the setting, you can refer to the professional application specification.

### 3. Applications

#### 3.1. Flow Chart

For filter valve only has service, backwash and fast rinse.

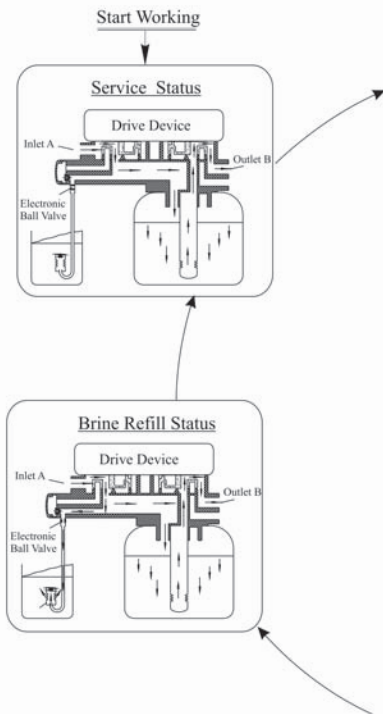

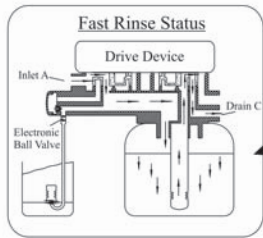
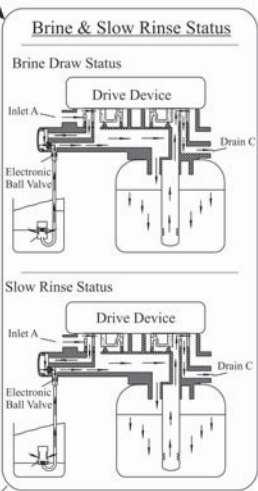
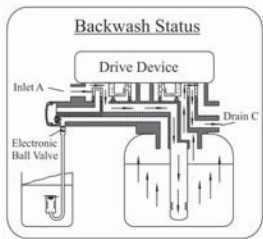

### 3.2. The Function and Connection of PC Board

Open the front cover of control valve, you will see the main control board and connection port as below:

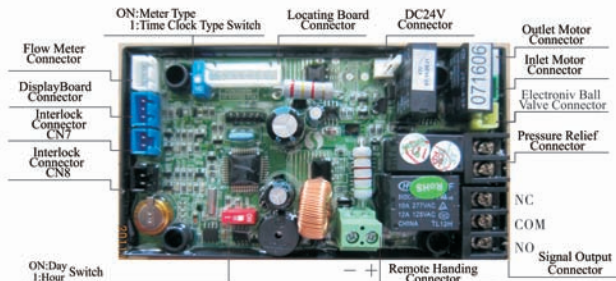

Functions on PC board:

Function	Application	Explanation
Signal output connector b-01	Outlet solenoid valve	If system strictly require no hard water flow from outlet or controlling the liquid level in water tank.
	Inlet pump	Increase pressure for regeneration or washing. Use the liquid level controller to control inlet pump to ensure there is water in tank.
Signal output connector b-02	Inlet solenoid valve or inlet pump	When inlet pressure is high, it needs to close water inlet when valve is rotating to protect motor.
Pressure relief connector	Control the inlet bypass to release pressure	When valve is rotating, pressure relief connector opened to prevent pressure increasing rapidly.
Interlock connector	To ensure only one valve regeneration or washing in system.	Use in RO Pre-treatment, water supply together but regeneration in turn. Second grade ion exchange equipment, etc.
Remote handling connector	Receipt signal to make the control rotate to next circle	It is used for on-line inspection system, PC connection, and realize automatically or remote controlling valve.



## MODEL: 63518-N77A1/63618-N77A3/53518-N77B1

### Instruction:

When inlet pressure is high, install a solenoid valve on inlet to ensure valve switching properly. When valve is exactly at position of Service, Backwash, Brine & Slow Rinse, Brine Refill and Fast Rinse, solenoid valve is open. When valve is switching, solenoid valve is closed, no water flow into valve to ensure valve switching properly. It could prevent the problem of mix water and water hammer.

Use interlock cable to realize valves in parallel and series in same system which is suited for RO pretreatment system or second grade Na<sup>+</sup> system. The Wiring refer to Figure 3-4:

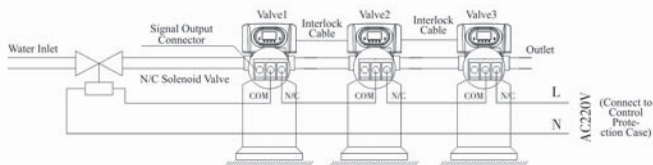

Figure 3-4 Wiring of Solenoid Valve in Inlet

### 2) Liquid Level Controller Controls Inlet Pump( Two-phase motor)( Set b-01)

Instruction: For the system using well or middle-tank supplying water, switch of liquid level controller and valve together control pump opening or closing.

The wiring refers to Figure 3-5:

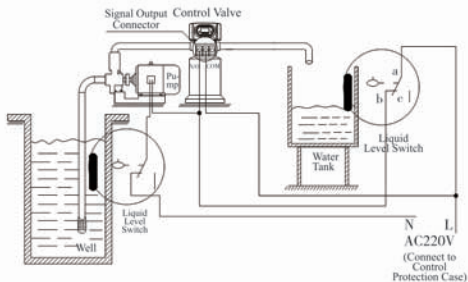

Figure 3-5 Wiring of Liquid Level Controller Controlling 220V Inlet Pump

**Function:**

When valve in service status, if water tank is short of water, start up pump, but if water tank has enough water, the switch of liquid level controller is closed, so pump doesn't work.

When valve in regeneration cycle, inlet always has water no matter what is water condition in water tank. As Runxin valve no water pass outlet in regeneration cycle, it ensure no water fill into brine tank.

A liquid switch at the top opening O well or in middle water tank in RO system protect pump from working without water in case of out of raw water.

**3 ) Liquid Level Switch in Water Tank Controls Inlet Pump (Three-phase) (Set b-01)**

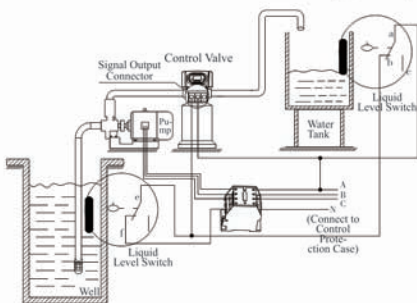

**Figure 3-6 Wiring of Liquid Level Switch in Water Tank Controls 380V Inlet Pump**

**4 ) Control Inlet Booster Pump( Set b-01 or b-02)**

Instruction: If inlet water pressure is less than 0.15MPa, which makes rinse drawing difficult, a booster pump is suggested to be installed on inlet. Control mode b-01. When system in regeneration cycle, booster pump is open, the wiring refer to Figure 3-7. IF the booster pump current us bigger than 5A, system need to install an contactor, the wiring refer to Figure3-8

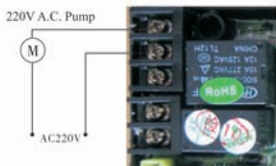

**Figure 3-7Wiring of Booster Pump on Inlet**

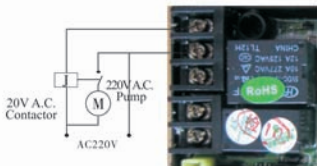

**Figure 3-8 Wiring of Booster Pump on Inlet**



## B. Interlock

Instruction: In the parallel water treatment system, it ensure only one valve in regeneration or washing cycle and (n-1) valves in service, that is, realizing the function of supplying water simultaneously and regenerating individually, the wiring refer to Figure3-9



Figure 3-9 Network System Wiring with Interlock Cable

Note: Use Interlock Cable to connect CN8 to CN7 on next valve in the loop.

One system with several valves, if interlock cable is disconnected, the system is divided into two individual system.

## C. Pressure Relief Output

Runxin valve will cut off feeding water to drain line when it switches in regeneration cycles. Thus in some water treatment system, e.g. Deep Well, one booster pump was installed on the inlet to increase the system water feeding pressure, this cut-off will cause pressure on inlet rising too fast to damage the valve. Pressure Relief Output can be used to avoid this problem. The wiring refer to Figure3-10

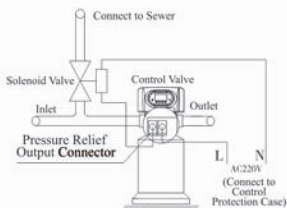

Figure 3-10 Wiring of Pressure Relief Output

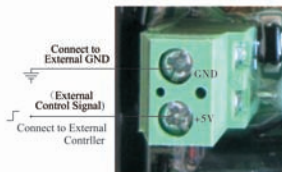

Figure 3-11 Wiring of Remote Input

### D. Remote Handling Connector

Online TDS meter monitors treated water other than a flow meter, or PLC controls the regeneration time. When the controller receives a contact closure from above instruments, regeneration begins. The wiring refers to Figure3-11:

### E. Interlock System

2 or more than 2 valves are interlocked connecting in one system and all valves are in service but regenerate individually. The wiring refers to Figure3-12.

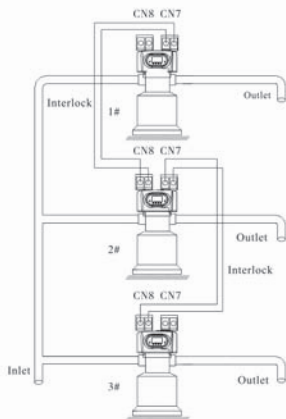

Figure 3-12 Interlock system

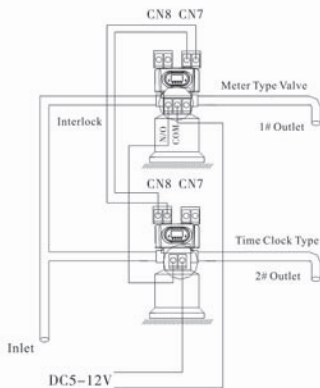

Figure 3-13 Series system

### F. Series System

This is a 2 or more than 2 valves system, all in service, with one flow meter for the entire system. For the time type valve, the regeneration time should be set and adjusted to the Max; for the volume type valve, connect its signal output connector with the remote handle connector of the time-type valve. That can realize the function of supplying water simultaneously and regenerating orderly. The wiring refer to Figure 3-13:

### 3.3. System Configuration and Flow Rate Curve

#### A. Product Configuration

Product configuration with tank, resin volume, brine tank and injector

Tank Size (mm)	Resin Volume (L)	Flow Rate (t/h)	Brine Tank Size (mm)	The Minimum Salt Consumption for Regeneration (Kg)	Injector Model
φ 750 × 1800	450	11.0	φ 840 × 1335	67.50	7702
φ 900 × 2400	900	16.0	φ 1080 × 1460	135.00	7703
φ 1000 × 2400	1100	20.0	φ 1240 × 1575	165.00	7704

Attention: The flow rate calculation is based on linear velocity 25m/hr; the minimum salt consumption for regeneration calculation is based on salt consumption 150g / L (Resin).

#### B. Flow Rate characteristic

##### 1). Pressure-flow rate curve

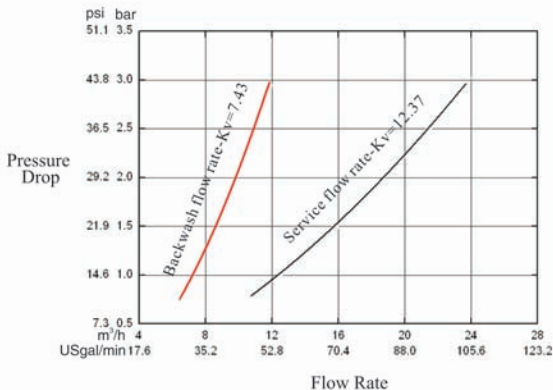

**MODEL: 63518-N77A1/63618-N77A3/53518-N77B1**

**2). Injector parameter table**

Inlet Pressure	Draw Rate (L/M)				
	7701 Coffee	7702 Pink	7703 Yellow	7704 Blue	7705 White
0.20	18.72	25.83	35.52	42.27	49.25
0.25	26.83	32.42	45.59	57.02	63.58
0.30	32.08	39.41	51.16	64.90	72.37
0.35	37.56	49.79	59.17	70.75	79.85
0.40	42.14	54.77	63.77	76.46	85.86

**3 ). Configuration for Standard Injector and Drain Line Flow Control**

Tank Dia. mm	Injector Model	Injector Color	Draw Rate	Slow Rinse	DLFC & Holes Quantity	Backwash Fast Rinse
			L/m	L/m		t/h
700	7701	Coffee	32	20	0	7.5
750	7702	Pink	39.5	26.5	0	7.5
800	7702	Pink	39.5	26.5	1 × $\phi$ 6	9.2
850	7703	Yellow	51.2	33.3	1 × $\phi$ 6	9.2
900	7703	Yellow	51.2	33.3	2 × $\phi$ 6	10.2
1000	7704	Blue	64.9	42	3 × $\phi$ 6	11.2
1050	7705	White	72.4	48.7	4 × $\phi$ 6	13

**Remark:**

- Above data for the product configuration and relevant characteristics are only for reference. When put in practice, please subject to the different requirements of raw water hardness and application.
- Above parameter is tested under 0.3MPa inlet pressure.
- Holes quantity is the holes number on DLFC. Diameter of hole is  $\phi$  6, the number refer to above table.

### 3.4. Parameter settlement

#### ① Service time T1

Water treatment capacity:  $Q = V_r \times K \div Y_D$  (m<sup>3</sup>)

Hardness of inlet water (mmol/L)

Exchange factor (mmol/L) 400~1000. Down-flow regeneration, take 400~750. Up-flow regeneration, take 450~1000. If the inlet water hardness is higher, the factor is smaller.

Resin volume (m<sup>3</sup>)

By hours:  $T1 = Q \div Q_h$  (Hour)

Water treatment capacity per hour (m<sup>3</sup>/h)

Water treatment capacity (m<sup>3</sup>)

By days:  $T1 = Q \div Q_d$  (day)

Water treatment capacity per day (m<sup>3</sup>/d)

Water treatment capacity (m<sup>3</sup>)

#### ② Backwash time T2

It is subject to the turbidity of inlet water. Generally, It is suggested to be set 10~15 minutes. The higher the turbidity is, the longer backwash time can be set. However, if the turbidity is more than 5FTU, it should be better to install a filter in front of the exchanger.

#### ③ Brine & slow rinse time T3

$$T3 = (40 \sim 50) \times H_r \text{ (min)}$$

Generally,  $T3 = 45H_r$  (min)

In this formula,  $H_r$  The height of resin in exchange tank (m.)

#### ④ Brine refill time T4

Down-flow regeneration:  $T4 = 0.45 \times V_r \div \text{Brine refill speed (min.)}$

Up-flow regeneration:  $T4 = 0.34 \times V_r \div \text{Brine refill speed (min.)}$

In this formula,  $V_r$  Resin volume (m<sup>3</sup>)

The Brine refill speed is related to inlet water pressure. It is suggested to lengthen 1~2 minutes of calculated brine refilling time to make sure there is enough water in tank. (The condition is that there is a level controller installed in the brine tank)

#### ⑤ Fast rinse time T5

$$T5 = 12 \times H_r \text{ (min.)}$$

Generally, the water for fast rinse is 3~6 times of resin volume. It is suggested to be set 10~16 minutes, but subject to the outlet water reaching the requirement.

⑥ Exchange factor

Exchange factor =  $E/(k \times 1000)$

In this formula, E—Resin working exchange capability ( mol/m<sup>3</sup> ), it is related to the quality of resin. Down-flow regeneration, take 800 ~ 900. Up-flow regeneration, take 900 ~ 1200.

K—Security factor, always take 1.2 ~ 2. it is related to the hardness of inlet water: the higher the hardness is, the bigger the K is.

⑦ Regeneration time

The whole cycle for generation is about two hours. Please try to set up the regeneration time when you don't need water according to the actual situation.

The calculation of parameters for each step is only for reference, the actual proper time will be determined after adjusting by water exchanger supplier. This calculation procedure of softener is only for industrial application; it is not suitable for small softener in residential application.



**3.5. Parameter Enquiry and Setting**

3.5.1. Parameter Enquiry

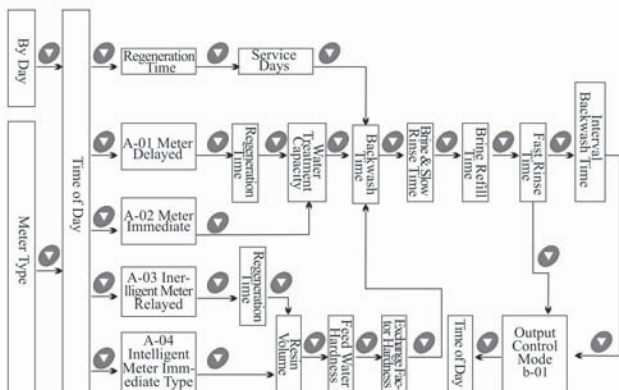







































When ☼ light on, press and hold both ▲ and ▼ for 5 seconds to lift the button lock status; then press ⏻ and ☼ light on, enter to program display mode; press or ▼ to view each value according to below process. ( Press ⏻ exit and turn back to service status )







































### 3.5.2.Parameter Setting

















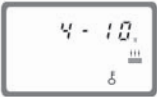







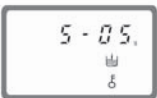

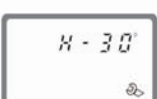

In program display mode, press  and enter into program set mode. Press  or  to adjust the value.

### 3.5.3.The steps of parameter setting













Items	Process steps	Symbol
Time of Day	When time of day “12:12” continuously flash, it reminds to reset; 1. Press  to enter into program display mode; both  and  symbol light on, “:” flash; Press  , both  and hour value flash, through  or  to adjust the hour value; 2. Press  again, both  and hour value flash, through  or  to adjust the minute value; 3. Press  and hear a sound “Di”, then finish adjustment, press  to turn back.	
Control Mode	1. In control mode display status, press  and enter into program set mode,  and 01 value flash; 2. Press  or  , set the value to be A-01, A-02, A-03 or A-04 control mode 3. Press  and hear a sound “Di”, then finish adjustment, press  to turn back.	
Regeneration Time	1. In regeneration time display status, press  and enter into program set mode.  And 02 flash; Press  or  to adjust the hour value; 2. Press  again,  and 00 flash, press  or  to adjust the minute value; 3. Press  and hear a sound “Di”, then finish adjustment, press  to turn back.	
Water Treatment Capacity	1. In water treatment capacity display status, it shows  and 80.0. Press  and enter into program set mode.  and 80.0 flash; 2. Press  or  to adjust the water treatment capacity value (m <sup>3</sup> ) ; 3. Press  and hear a sound “Di”, then finish adjustment, press  to turn back.	

Resin Volume	<p>1. In resin volume display status, it shows 100L. Press  and enters into program set mode.  and 100 value flash;</p> <p>2. Press  or  to adjust the volume value(L);</p> <p>3. Press  and hear a sound “Di” , then finish adjustment, press  to turn back.</p>	
Feed Water Hardness	<p>1. In feed water hardness display status, it shows yd1.2. Press  and enter into program set mode.  and 1.2 value flash;</p> <p>2. Press  or  to adjust the volume value(L);</p> <p>3. Press  and hear a sound “Di” , then finish adjustment, press  to turn back.</p>	
Exchange Factor	<p>1. In exchange factor display status, it shows AL.55. Press  and enter into program set mode.  and 55 flash;</p> <p>2. Press  or  to adjust the exchange factor value;</p> <p>3. Press  and hear a sound “Di” then finish adjustment, press  to turn back.</p>	
Backwash Time	<p>1. In backwash time display status, it shows  and 2-10. Press  and enter into program set mode.  and 10 flash;</p> <p>2. Press  or  to adjust the backwash time;</p> <p>3. Press  and hear a sound “Di” then finish adjustment, press  to turn back.</p>	
Brine & Slow Rinse Time	<p>1. In brine&amp; slow rinse time display status, it shows  and 3-60:00. Press  and enter into program set mode.  and 60:00 flash;</p> <p>2. Pressor  to  adjust the brine time;</p> <p>3. Press  and hear a sound “Di” then finish adjustment, press  to turn back.</p>	



<p>Fast Rinse Time</p>	<p>1. In fast rinse time display status, it shows  and 4-10. Press  and enter into program set mode.  and 10:00 flash; 2. Press  or  to adjust the fast rinse time; 3. Press  and hear a sound “Di”, then finish adjustment, press  to turn back.</p>	
<p>Brine Refill Time</p>	<p>1. In brine refill time display status, it shows  and 5-05:00, Press  and enter into program set mode.  And 05:00 flash; 2. Press  or  to modify the brine refill time; 3. Press  and hear a sound “Di”, then finish adjustment, press  to turn back.</p>	
<p>Maximum Interval Regeneration Days</p>	<p>1. In maximum Interval regeneration days display status, it shows H-30. Press  and enter into program set mode.  And 30 flash; 2. Press  or  to adjust the Interval regeneration days; 3. Press  and hear a sound “Di”, then finish adjustment, press  to turn back.</p>	
<p>Signal Output Mode</p>	<p>1. In signal output mode display status, it shows b-01. Press  and enter into program set mode.  and 01 flash; 2. Press  or  to adjust the b-02; 3. Press  and hear a sound “Di”, then finish adjustment, press  to turn back.</p>	

For example, the fast rinse time of a softener is 12 minutes. After regenerating, the chloridion in the outlet water is always higher than normal, indicating that there is not enough time for fast rinse. If you want the time to set to 15 minutes, the modification steps as follows:

- ① Press and hold both  and  to lift the button lock statues (  light off ) ;
- ② Press  , and  light on;
- ③ Press  or  continuously until  light on. Then the digital area shows: 4-12M;
- ④ Press  ,  and 12 flash;
- ⑤ Press  continuously until 12 changed to 15;
- ⑥ Press  , there is a sound “Di” and the figure stop flashing; the program back to enquiry status.



⑦ If you want to adjust other parameters, you can repeat the steps from ② to ⑤; If you don't, press  and quit from the enquiry status, the display will show the current service status.



#### 6. Trial running



After installing the multi-functional flow control valve on the resin tank with the connected pipes, as well as setting up the relevant parameter, please conduct the trial running as follows:



A. Close the inlet valve B & C, and open the bypass valve A. After cleaning the foreign materials in the pipe, close the bypass valve A. (as Figure 1-3 shows)



B. Fill the brine tank with the planned amount of water and adjust the air check valve. Then add solid salt to the tank and dissolve the salt as much as possible.

C. Switch on power. Press  and go in the Backwash position; when  light on, slowly open the inlet valve B to 1/4 position, making the water flow into the resin tank; you can hear the sound of air-out from the drain pipeline. After all air is out of pipeline, then open inlet valve B completely and clean the foreign materials in the resin tank until the outlet water is clean. It will take 8~10 minutes to finish the whole process.

D. Press , turning the position from Backwash to Brine& Slow Rinse;  light on and enter in the process of Brine& Slow Rinse. The air check valve close when control valve finished sucking brine, then slow rinse start to work. It is about 60~65minutes for whole process.

E. Press  to Fast rinse position.  light on. It takes about 10~15minutes, take out some outlet water for testing: if the water hardness reach the requirement, and the chloridionin the water is almost the same compared with the inlet water, then go to the next step.

F. Press  to Brine refill position.  light on and it indicates the brine tank is being refilled with water to the required level. It takes about 5~6minutes, then add solid salt to the brine tank.

G. Press , making the control valve return to Service Status;  light on and start to running.

#### Note:

● When the control valve enter into the regeneration status, all program can be finished automatically according to the setting time; if you want one of steps terminated early, you can press .

● If water inflow too fast, the media in tank will be damaged. When water inflow slowly, there is a sound of air emptying from drain pipeline.

● After changing resin, please empty air in the resin according to the above Step C.

● In the process of trial running, please check the water situation in all position, ensuring there are no resin leakage.

● The time for Backwash, Brine& Slow Rinse, Brine Refill and Fast Rinse position can be set and executed according to the calculation in the formula or suggestions from the control valve suppliers.

### 3.7. Trouble-Shooting

#### A. Control Valve Fault

Problem	Cause	Correction
1. Softener fails to regenerate.	A. Electrical service to unit has been interrupted. B. Regeneration cycles set incorrect. C. Controller is defective. D. Motor fails to work.	A. Assure permanent electrical service (Check fuse, plug, pull chain or switch). B. Reset regeneration cycles. C. Replace controller. D. Replace motor.
2. Regeneration time is not correct.	A. Time of Day not set correctly. B. Power failure more than 3 days.	A. Check program and reset time of day. B. Reset time of day.
3. Softener supply hard water.	A. Bypass valve is open or leaking. B. No salt in brine tank. C. Injector plugged. D. Insufficient water flowing into brine tank. E. Leak at O-ring on riser pipe. F. Internal valve leak. G. Regeneration cycles not correct. H. Shortage of resin. I. Bad quality of feed water or turbine blocked.	A. Close or repair bypass valve. B. Add salt to brine tank . C. Change or clean injector. D. Check brine tank refill time. E. Make sure riser pipe is not cracked. Check o-ring and tube pilot. F. Change valve body. G. Set correct regeneration cycles in the program. H. Add resin to mineral tank and check whether resin leaks. I. Reduce the inlet turbidity, clean or replace turbine.
4. Softener fails to draw brine.	A. Line pressure is too low. B. Brine line is plugged. C. Brine line is leaking. D. Injector is plugged. E. Internal control leak. F. Drain line is plugged. G. Sizes of injector and DLFC not match with tank. H. Ball valve or cable failure	A. Increase line pressure. B. Clean brine line. C. Replace brine line. D. Clean or replace new parts. E. Replace valve body. F. Clean drain line flow control. G. Select correct injector size and DLFC according to the Instruction requirements. H. Replace ball valve or cable
5. Unit used too much salt.	A. Improper salt setting. B. Excessive water in brine tank.	A. Check salt usage and salt setting. B. See problem no.6.

Control Valve Fault

<p>6.Excessive water in brine tank.</p>	<p>A. Overlong refilling time. B. Too much water left after brine. C. Foreign material in brine valve and plug drain line flow control. D. Not install safety brine valve but power failure while salting. E. Safety brine valve breakdown. F. Ball valve doesn't close</p>	<p>A. Reset correct refilling time. B. Check the injector or brine pipe line if it is blocked. C. Clean brine valve and brine line. D. Stop water supplying and restart power install safety brine valve in salt tank. E. Repair or replace safety brine valve. F. Close or replace ball valve or cable</p>
<p>7.Pressure lost or iron in conditioned water.</p>	<p>A. Iron in the water supply pipe. B. Iron mass in the softener. C. Fouled resin bed. D. Too much iron in the raw water.</p>	<p>A. Clean the water supply pipe. B. Clean valve and add resin cleaning chemical, increase frequency of regeneration. C. Check backwash, brine draw and brine tank refill. Increase frequency of regeneration and backwash time. D. Iron removal equipment is required to install before softening.</p>
<p>8.Loss of mineral through drain line.</p>	<p>A. Air in water system. B. Bottom strainer broken. C. Improperly sized drain line control.</p>	<p>A. Assure that well system has proper air eliminator control. B. Replace new bottom strainer. C. Check for proper drain rate.</p>
<p>9.Control cycle continuously.</p>	<p>A. Locating signal wiring Breakdown. B. Controller is faulty. C. Foreign material stuck the driving gear. D. Time of regeneration steps were set to zero.</p>	<p>A. Check and connect locating signal wiring. B. Replace controller. C. Take out foreign material. D. Check program setting and reset.</p>
<p>10.Drain flows continuously.</p>	<p>A. Internal valve leak. B. When electricity fails to supply, valve stops backwash or rapid rinse position.</p>	<p>A. Check and repair valve body or replace it. B. Adjust valve to service position or turn off bypass valve and restart when electricity supply.</p>
<p>11.Interrupted or irregular brine.</p>	<p>A. Water pressure too low or not stable. B. Injector is plugged or faulty. C. Air in resin tank. D. Floccules in resin tank during backwash.</p>	<p>A. Increase water pressure. B. Clean or replace injector. C. Check and find the reason. D. Clean the floccules in resin tank.</p>
<p>12.Water flow out from drain or brine pipe after regeneration.</p>	<p>A. Foreign material in valve which makes valve can't be closed completely. B. Hard water mixed in valve body. C. Water pressure is too high which result in valve doesn't get the right position. D. Ball valve or cable failure</p>	<p>A. Clean foreign material in valve body. B. Change valve core or sealing ring. C. Reduce water pressure or use pressure release function. D. Replace ball valve or cable.</p>

**Control Valve Fault**

13. Salt water in soften water.	A. Foreign material in injector pr injector fails to work. B. Brine valve cannot be shut-off. C. Time of rapid rinse too short.	A. Clean and repair injector. B. Repair brine valve and clean it. C. Extend rapid rinse time.
14. Unit capacity decreases.	A. Unit fails to regenerate or regenerate not properly. B. Fouled resin bed. C. Salt setting not proper. D. Softener setting not proper. E. Raw water quality deterioration. F. Turbine of flow meter is stuck.	A. Regenerate according to the correct operation requirement. B. Increase backwash flow rate and time, clean or change resin. C. Readjust brine drawing time. D. According to the test of outlet water, recount and reset. E. Regenerate unit by manual temporary then reset regeneration cycle. F. Disassemble flow meter and clean it or replace a new turbine.

**B. Controller Fault**

Problem	Cause	Correction
1. All indicators display on front panel.	A. Wiring of front panel with controller fails to work. B. Control board is faulty. C. Transformer damaged. D. Electrical service not stable.	A. Check and replace the wiring. B. Replace control board. C. Check and replace transformer. D. Check and adjust electrical service.
2. No display on front panel.	A. Wiring of front panel with controller fails to work. B. Front panel damaged. C. Control board damaged. D. Electricity is interrupted.	A. Check and replace wiring. B. Replace front panel. C. Replace control board. D. Check electricity.
3. E1 Flash	A. Wiring of locating board with controller fails to work. B. Locating board damaged. C. Mechanical driven failure. D. Faulty control board. E. Wiring of motor with controller is fault. F. Motor damaged.	A. Replace wiring. B. Replace locating board. C. Check and repair mechanical part. D. Replace control board. E. Replace wiring. F. Replace motor.
4. E2 Flash	A. Hall component on locating board damaged. B. Wiring of locating board with controller fails to work. C. Control board is faulty.	A. Replace locating board. B. Replace wiring. C. Replace control board.
5. E3 or E4 Flash	A. Control board is faulty.	A. Replace control board.

MODEL: 63518-N77A1/63618-N77A3/53518-N77B1

**8. Assembly & Parts**

N77A3/63618 exploring drawing

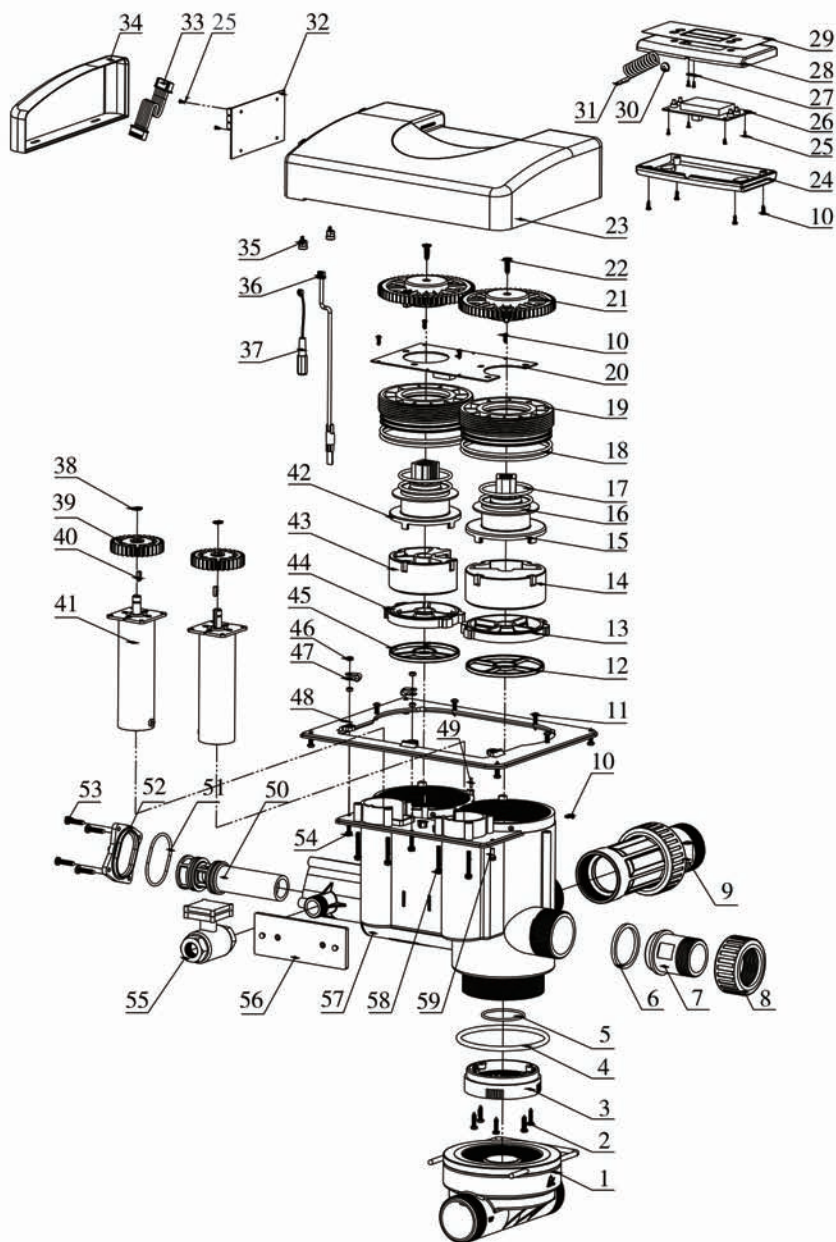

MODEL: 63518-N77A1/63618-N77A3/53518-N77B1

## N77A1/N77A3 Valve Body Components (Item No. 9, 36 only for N77A3)

Item No.	Description	Part Number	Quantity	Item No.	Description	Part Number	Quantity
1	Side-mounted Connector	5458002	1	31	Three-core Spring	5517001	1
2	Screw, Cross ST3.9×13	8909003	5	32	Control Board	6382030	1
3	Connector	8458018	1	33	Wire for Locating Board	5511006	1
4	O-ring 104.6 × 5.7	8378146	1	34	Front Cover	8300012	1
5	O-ring 50.47×2.62	8378308	1	35	Toggle	8126004	2
6	Sealing Gasket	8371008	1	36	Probe wire	6386003	1
7	Brine Line Flow Control	8468012	1	37	Wire for power	5513001	1
8	Animated Connector	8947005	1	38	Locking Ring	8994009	2
9	Flow meter	5447003	1	39	Small Gear	5241008	2
10	Screw, Cross ST2.9×9.5	8909008	14	40	Button C4 × 12	8971001	2
11	Screw, Cross ST3.9×16	8909016	8	41	Motor	6158036	2
12	Sealing Ring	8370044	1	42	Shaft	8258012	1
13	Fixed Disc	8469022	1	43	Fixed Disc	8459023	1
14	Moving Disc	8459024	1	44	Moving Disc	8469021	1
15	Shaft	8258005	1	45	Wire for power	8370042	1
16	Anti-friction Washer	8216006	2	46	Hexagonal Nut	8940002	5
17	O-ring 59.92×3.53	8378110	4	47	Cable clip	8126002	2
18	O-ring 107.54 × 3.53	8378112	4	48	Junction Plate	8152009	1
19	Pressure Nut	8092009	2	49	Pin 2.5 × 12	8993004	2
20	Locating board	6380017	1	50	Injector	5468019	1
21	Gear	5241007	2	51	O-ring 52×3	8378096	1
22	Screw, Cross ST4.8 × 19	8909018	2	52	Injector Cover	8315007	1
23	Dust Cover	8005011	1	53	Screw, Cross ST4.8×25	8909021	4

**MODEL: 63518-N77A1/63618-N77A3/53518-N77B1**

24	Board Back Cover	8315008	1		54	Screw, Cross M4 x 20	8902007	2
25	Screw, Cross ST2.2 x 6.5	8909004	8		55	3/4" Ball Valve	2976008	1
26	Display Board	6381007	1		56	Display Shelf	8040003	1
27	Cable clip	8126001	1		57	Valve Body (ABS+GF10)	8022057	1
28	Board Front Cover	8300013	1			Valve Body (PPO+GF10)	8022139	
29	Sticker	8865011	1		58	Screw, Cross M4 x 32	8902010	8
30	Bushings	8126006	1		59	Screw, Cross M4 x 12	8902005	1

N77B, there are no items 6, 7, 8, 9, 36 and 55. But increase one piece seal ring 8371019 and one piece blind nut 8940004.



**MODEL: 63518-N77A1/63618-N77A3/53518-N77B1**

5447003 Flow meter:

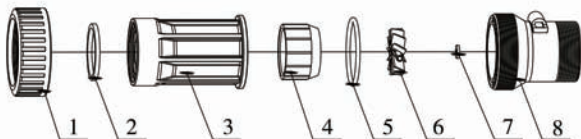

5447003 Flow Meter Components:

Item No.	Description	Part No	Quantity	Item No.	Description	Part No	Quantity
1	Animated Connector	8947004	1	6	Turbine	5436005	1
2	Seal Ring	8371008	1	7	Rotator	8210002	1
3	Connector	8458016	1	8	Flow Meter Shell	8002702	1
4	Fixed Connector	8109006	1				
5	O-ring 60 × 4	8378137	1				

5458002 Side-mounted Connector:

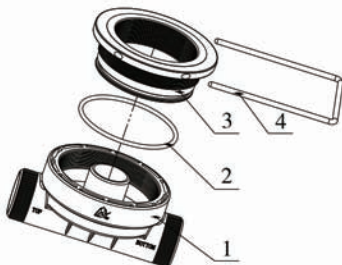

5458002 Side-mounted Connector Components:

Item No.	Description	Part No	Quantity	Item No.	Description	Part No	Quantity
1	Connector	8458037	1	3	Joint	8457017	1
2	O-ring 110×4.5	8378140	1	4	Steel Yoke End	8271003	1

## 4. Warranty Card

Dear client:

This warranty card is the guarantee proof of RUNXIN brand multi-functional flow control valve. It is kept by client self. You could get the after-sales services from the supplier which is appointed by RUNXIN manufacturer. Please keep it properly. It couldn't be retrieved if lost. It couldn't be repaired free of charge under the below conditions:

1. Guarantee period expired.(One year);
2. Damage resulting from using, maintenance, and keeping that are not in accordance with the instruction.
3. Damage resulting from repairing not by the appointed maintenance personnel.
4. Content in guarantee proof is unconfirmed with the label on the real good or be altered.
5. Damage resulting from force majeure.

Product Name	 Multi-functional Flow Control Valve for Water Treatment Systems		
Model		Code of Valve Body	
Purchase Company Name		Tel/Cel.	
Problem			
Solution			
Date of Repairing	Date of Accomplishment		Maintenance Man Signature

When product need warranty service, please fill in the below content and sent this card together with the product to the appointed suppliers or Runxin company.

End-user Company Name		Tel/Cel.	
Purchase Company Name		Tel/Cel.	
Model		Code of Valve Body	
Tank Size $\phi \times$	Resin Tank Size L	Raw Water Hardness	Mmol/L
Water Source: Ground-water <input type="checkbox"/> Tap Water <input type="checkbox"/>	Water Treatment Capacity m <sup>3</sup>	Backwash Time	min
Brine & Slow Rinse Time min	Brine Refill Time min	Fast Rinse Time	min
Problem Description			



---

**WENZHOU RUNXIN MANUFACTURING MACHINE CO.,LTD**

ADD: NO.169, RUNXIN ROAD, SHANFU TOWN, WENZHOU, ZHEJIANG, CHINA.

TEL.:0086-577-88630038, 88576512, 85956057      FAX:0086-577-88633258

E-MAIL: [sales@run-xin.com](mailto:sales@run-xin.com)      <http://www.run-xin.com>