



China patent No.: ZL201520680239.8

Multi-functional Flow Control Valve for Water Treatment Systems

63508 (Old Model: F133A1)

63608 (Old Model: F133A3)

53508 (Old Model: F134A1)

53608 (Old Model: F134A3)

User manual



**Please read this manual in details
before using this valve and keep it properly
in order to consult in the future**

0WRX.466.726

Before the valve put into use, please fill in the below content so as to help us to refer in the future.

Softener System Configuration

Tank Size: Dia. _____ mm, Height _____ mm:

Resin Volume _____ L; Brine Tank Capacity _____ L:

Hardness of Raw Water _____ mmol/L:

Pressure of Inlet Water _____ MPa:

Control Valve Model _____ ; Number _____ ;

The Specification of Drain Line Flow Control _____ ;

Injector No. _____.

Water Source: Ground-water Filtered Ground-water Tap Water Other _____.

Parameter Set

Parameter	Unit	Factory Default	Actual Value
Time of Day	h:m	Current Time	
Control Mode A-01/02/03/04(Only for 63608), A-01/02(Only for 53608)	/	A-01	
Regeneration/ Rinsing Time (63608: A-01/03,53508: A-01)	h:m	02:00	
Rinsing Frequency (Only for 53508/53608)	/	F-00	
Water Treatment Capacity (63608/53608 in A-01/02 control mode)	m ³	80.00	
Service Days (Only for 63508/53508)	D	03	
Backwash Time	min	10	
Brine Draw Time (Only for 63608/63508)	min	60	
Fast Rinse Time	min	10	
Brine Refill Time(Only for 63608/63508)	min	05	
Maximum Interval Regeneration Days(Only for 63608/53608)	D	30	
Signal Output Mode b-01/02	/	b-01	
Valve Address(Valve's number in system)	/	1	

● If there is no special requirement when purchasing product, the size of riser pipe is 1.25"GB (outer diameter is 40mm), we choose 4# drain line flow control and 3# injector for the standard configuration for 63508 and 63608.

Catalogue

Notice.....	4
1. Product Overview.....	5
1.1. Main Application & Applicability.....	5
1.2. Product Characteristics.....	5
1.3. Service Condition.....	7
1.4. Product Structure and Technical Parameters.....	8
1.5. Installation.....	10
2. Basic Setting & Usage.....	13
2.1. The Function of PC Board.....	13
2.2. Basic Setting & Usage.....	14
3. Applications.....	17
3.1. Flow Chart.....	17
3.2. The Function and Connection of PC Board.....	19
A. Signal Output Connector.....	20
B. Interlock.....	23
C. Remote Handling Connector.....	24
D. Interlock System.....	24
E. Series System.....	24
F. 485 communication between PLC and Single Valve.....	24
G. 485 communication among PLC and Multi-Valves.....	24
3.3. RS-485 Port.....	24
3.4. System Configuration and Flow Rate Curve.....	29
3.5. Parameter Settlement.....	31
3.6. Parameter Enquiry and Setting.....	34
3.7. Trial Running.....	35
3.8. Trouble-Shooting.....	35
3.9. Assembly & Parts.....	39
4. Warranty Card.....	54

Notice

- To ensure normal operation of the valve, please consult with professional installation or repairing personnel before use it.
- If there are any of pipeline engineering and electric works, there must be finished by professional at the time of installation.
- Do not use the control valve with the water that is unsafe or unknown quality.
- Depending on the changing of working environment and water requirement, each parameter of softener should be adjusted accordingly.
- When the water treatment capacity is too low, please check the resin. If the reason is shortage of resin, please add; if the resin is turn to reddish, brown or broken, please replace.
- Test water periodically to verify that system is performing satisfactorily.
- Sodium used in the water softening process should be considered as part your overall dietary salt intake. Contact doctor if you are on a low sodium diet.
- Ensure that there is solid salt all the time in the brine tank in the course of using, when this valve is used for softening. The brine tank should be added crystalline coarse salt only, at least 99.5% pure, forbidding use the small salt.
- Do not put the valve near the hot resource, high humidity, corrosive, intense magnetic field or intense vibrations environment. And do not leave it outside.
- Forbidden to carry the injector body. Avoid to use injector body as support to carry the system.
- Forbidden to use the brine tube or other connectors as support to carry the system.
- Please use this product under the water temperature between 5 ~ 50℃, water pressure 0.2 ~ 0.6MPa. Failure to use this product under such conditions voids the warranty.
- If the water pressure exceeds 0.6MPa, a pressure reducing valve must be installed in front of the water inlet; While, if the water pressure is under 0.2MPa, a booster pump must be installed in front of the water inlet.
- It is suggested to install PPR pipe, corrugated pipe or UPVC pipe, instead of TTLSG pipe. Pipeline should be installed straightly.
- Do not let children touch or play, because careless operations may cause the procedure changed.
- When the attached cables or trasformer of this product are damaged, they must be changed to the one that is from our factory.

1. Product Overview

1.1. Main Application & Applicability

Used for softening, demineralization or filtration water treatment systems.

53508/53608 (Filter)

Suit for swimming pool filter equipment

Filtration system

Active carbon and sand filter in RO pretreatment system

63508/63608 (Down-flow regeneration softener)

Suit for ion exchange equipment which hardness of the raw water $\leq 6.5\text{mmol/L}$

Boiler softening water system

RO pretreatment softening system

1.2. Product Characteristics

● Simple structure and reliable sealing

It adopts hermetic head faces with high degree pottery and corrosion resistance for opening and closing.

● No water passes the valve in regeneration in single tank type

● Manual function

Realize regeneration immediately by pressing “” at any time.

● Reserved pressure gauge connector

There is a pressure gauge connector reserved at the water inlet, drill and fit on the pressure gauge when you need.



● Long outage indicator

If outage overrides 3 days, the time of day indicator “12:12” will flash to remind people to reset new time of day. The other set parameters do not need to reset. The process will continue to work after power on.





● LED dynamic screen display

The stripe on dynamic screen flash, it indicates the control valve is in service, otherwise, it is in regeneration cycle.

● Buttons lock

No operations to buttons within 1 minute, button lock indicator lights on which represents buttons are locked. Before operation, press and hold the “” and “” buttons for 5 seconds to unlock. This function can avoid incorrect operation.

● It can choose valve model by program selection

When all symbols light on, press and hold “” and “” buttons more than 2 seconds to enter the menu of valve model selection. Press “” or “” buttons to select the requested model, then press “” button to save the selection. Reconnect the power, the model will be showed on screen.

● Interlock function

It has a function of interlock to realize only one valve in regeneration but the other valves are in service while several valves parallel in system. In multi-steps treatment systems such as RO pre-treatment, when several valves are in series, there is only one valve in regeneration or washing to ensure pass water all the times while different valves in regeneration or washing. (Application refers to Figure 3-8)

● Signal output (Take 63608/63508 as an example)

There is a signal output connector on main control board. It is applied for controlling external wiring. (Refer to Figure 3-1 to Figure 3-7).

There are two kinds of output modes: b-01 Mode: Turn on when start regeneration and shut off at the end of regeneration; b-02 Mode: Signal is available only at intervals of each status. Refer to below figure:

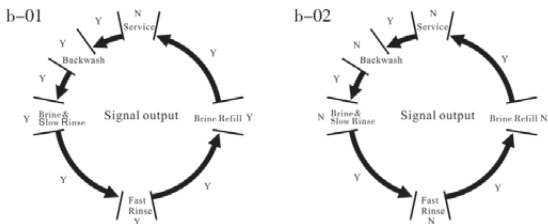

● Pressure relief connector (Set signal output as b-02)

The valve will cut off feeding water to drain line when it switches in regeneration cycles (Same as signal output b-02). Thus in some water treatment system, e.g. Deep Well, one booster pump was installed on the inlet to increase the system water feeding pressure, this cut-off will cause pressure on inlet rising too fast to damage the valve. Pressure Relief Output can be used to avoid this problem. (Application refers to Figure 3-2)

● Remote handling input

This connector can receive external signal, used together with PLC, and computer etc. to control the valve remotely. (Application refer to Figure 3-9)

● RS-485 port

RS-485 port is a remote communication connector to realize remote collection and control of the on site data of the control valve. It can operate the control valve remotely with the upper computer such as PLC. (Application refers to Figure 3-12/13)

● **All parameters can be modified**

According to the water quality and usage, the parameters in the process can be adjusted.

● **Four kinds of meter type can be selected (Suit for 63608)**

Mode	Name	Instruction
A-01	Meter delayed regeneration	Regenerate on the day although the available volume of treated water drops to zero (0). Regeneration starts at the regeneration time.
A-02	Meter immediate regeneration	Regenerate immediately when the available volume of treated water drops to zero (0).
A-03	Intelligent meter delayed regeneration	Meter delayed regeneration type, but by setting resin volume, feed water hardness, regeneration factor, the controller will calculate the system capacity.
A-04	Intelligent meter immediate regeneration	Meter immediate regeneration type, but by setting resin volume, feed water hardness, regeneration factor, the controller will calculate the system capacity.

● **Maximum interval regeneration days (Suit for 63608/53608)**

Under the situation of service reaching the setting days and the volume not yet, it could enter into regeneration process forcibly when current time is same as regeneration time.

1.3. Service Condition

Runxin valve should be used under the below conditions:

Items		Requirement
Working conditions	Water pressure	0.2MPa~0.6MPa
	Water temperature	5℃~50℃
Working environment	Environment temperature	5℃~50℃
	Relative humidity	≤95% (25℃)
	Electrical facility	AC100~240V/50~60Hz
Inlet water quality	Water turbidity	Filter (53508/53608) < 20FTU Down-flow regeneration (63508/63608) < 5FTU
	Water hardness	First Grade Na ⁺ < 6.5mmol/L; Second Grade Na ⁺ < 10mmol/L
	Free chlorine	< 0.1mg/L
	Iron ²⁺	< 0.3mg/L
	CODMn	< 2mg/L (O ₂)

In the above table, First Grade Na⁺ represents First Grade Na⁺ Exchanger. Second Grade Na⁺ represents Second Grade Na⁺ Exchanger.

● When the water turbidity exceeds the conditions, a filter should be installed on the inlet of control valve.

● When the water hardness exceeds the conditions, the outlet water hardness will hardly reach the requirement of boiler feed water (0.03 mmol/L). It is suggested to adopt second grade softener.

1.4. Product dimension and parameter

A. Product dimension (The appearance is just for reference. It is subjected to the real product.)

Structure of 63508/63608

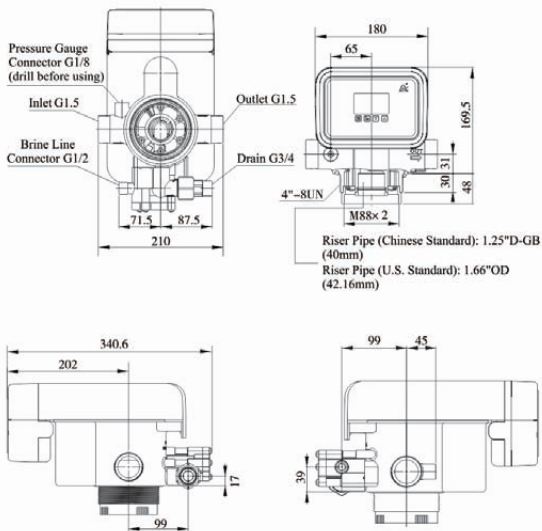

Structure of 53508/53608

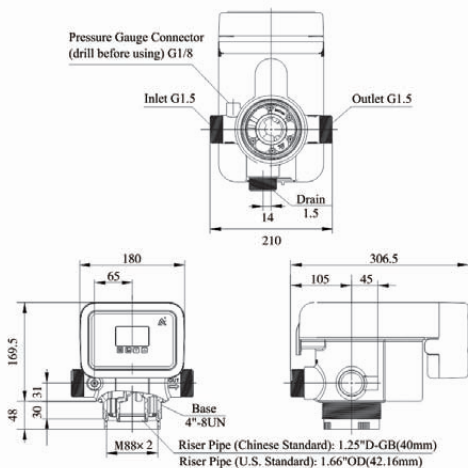

Structure of Flow Meter (5447010)

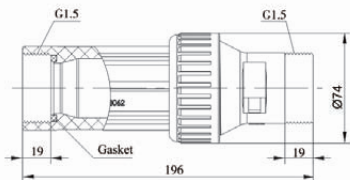

B. Technical Parameters

Model	Connector Size						Flow Rate m ³ /h @0.1MPa	Remark
	Inlet/ Outlet	Drain	Brine Line Connector	Pressure Gauge Connector	Base	Riser Pipe		
53508	1.5" M	1.5" M	/	1/8" M	4"-8UN	1.25"D-GB(Outer diameter 40mm) or 1.66"OD(Outer diameter 42.16mm)	8	Filter, time clock type
53608								Filter, meter type
63508	1.5" M	1.5" M	1/2" M	1/8" M	4"-8UN	1.25"D-GB(Outer diameter 40mm) or 1.66"OD(Outer diameter 42.16mm)	8	DF softener, time clock type
63608								DF softener, meter type
Transformer Input			AC100~240V/50~60Hz					
Transformer Output			DC24V、1.5A					

Remark: M--Male F-Female

There are two standards of riser pipe: Chinese and US standard, the factory default is Chinese standard. Please specify when ordering if you need the U.S. standard riser pipe.

1.5. Installation

A. Installation notice

Before installation, read all those instructions completely. Then obtain all materials and tools needed for installation.

The installation of product, pipes and circuits, should be accomplished by professional to ensure the product can operate normally.

Perform installation according to the relative pipeline regulations and the specification of Water Inlet, Water Outlet, Drain Outlet, and Brine Line Connector.

B. Device location

- ①The filter or softener should be located close to drain.
- ②Ensure the unit is installed in enough space for operating and maintenance.
- ③Brine tank need to be close to softener.
- ④The unit should be kept away from the heater, and not be exposed outdoor. Sunshine or rain will cause the system damage.
- ⑤Please avoid installing the system in one acid/alkaline, magnetic or strong vibration circumstance, because above factors will cause the system disorder.
- ⑥Do not install the filter or softener, drain pipeline in circumstance which temperature may drop below 5℃, or above 50℃.
- ⑦Install the system in the place where with the minimum loss in case of water leaking.

C. Pipeline installation (Take 63608 as an example)**① Install control valve**

a. If it is necessary to install the pressure gauge at the inlet, drill through the pressure gauge port of control valve and remove the drilling cuttings before installing control valve.

Apply 704 silicone on the threaded surface of the pressure gauge connector and then screw into pressure gauge port.

b. As the Figure 1-1 shows, insert the riser pipe to the bottom strainer, glue the connection part, and put it into the bottom tank, cut off the exceeding pipe out of tank top opening. Plug the riser pipe in case of mineral entering.

c. Fill the resin to the tank, and the height is accordance with the design code.

d. Screw top strainer to valve body with five pieces of screws.

e. Insert the top strainer to the valve.

f. Insert the riser tube into control valve and screw tight control valve.

Note:

- Install the pressure gauge is recommended to use 704 silicone as a seal, if use PTFE tape as seal, it should be noted that PTFE tape should not be wrapped too thick, it is advisable to see the thread contour after pressing the PTFE tape.

- The length of riser pipe should not be higher than tank top opening height, and should not be lower than 7mm tank top opening height, and its top end should be rounded to avoid damage of O-ring inside the valve.

- Avoid filling floccules substance together with resin fill in the mineral tank.

- Avoid O-ring inside control valve falling out while rotating it on the tank.

② Install flow meter (suit for 63608 and 53608)

As Figure 1-2 shows, put the sealing ring into nut of flow meter, screw in water outlet; insert the probe wire into flow meter.

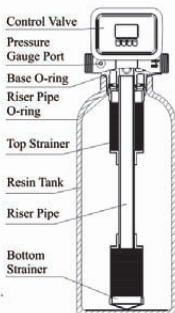

Figure 1-1

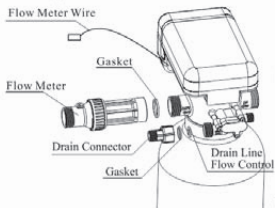

Figure 1-2

③Install drain connector (suit for 63508 and 63608)

As Figure1-2 shows, insert drain line flow control into drain outlet, then insert the gasket into drain connector, and screw drain connector into drain outlet.

④Pipeline connection

a.As figure 1-3 shows, install ball valve A, B, C, sampling valve, check valve in inlet, outlet, inlet pipeline and outlet pipeline.

b.Inlet pipeline should be in parallel with outlet pipeline.

c.Support inlet and outlet pipeline with fixed holder.

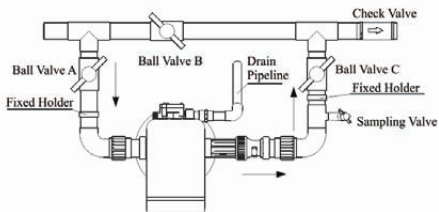

Figure 1-3

Note:

- If making a soldered copper installation, do all sweat soldering before connecting pipes to the valve. Torch heat will damage plastic parts.
- When turning threaded pipe fittings onto plastic fitting, use care not to cross thread or broken valve.

⑤Install drain pipeline

As figure 1-3 shows, glue the drain outlet with UPVC drain pipeline, put drain outlet pipe to sewer as showed in the Figure 1-4.

Note:

- Control valve should be higher than drain outlet, and be better not far from the drain hose.
- Be sure not connect drain with sewer directly, and leave a certain space between them, avoid wastewater be absorbing to the water treatment equipment.



Figure 1-4

⑥Connect brine tube (suit for 63508 and 63608)

a.As Figure1-5 shows, slide brine tube hose connector over end of brine tube.

b.Insert tube bushing into the end of brine tube.

c.Tighten brine draw hose connector onto brine line connector.

d.Connect the other end of brine tube with the brine tank. (The liquid level controller and air-blocker should be installed in the brine tank.)

Note:

- Keep brine tube short and smooth.
- Brine valve must be installed in brine tank.

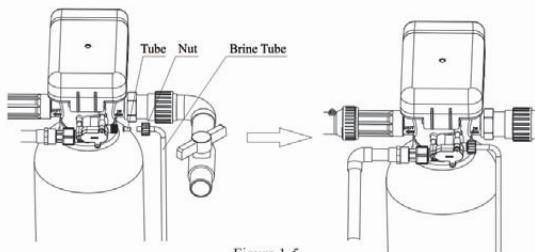
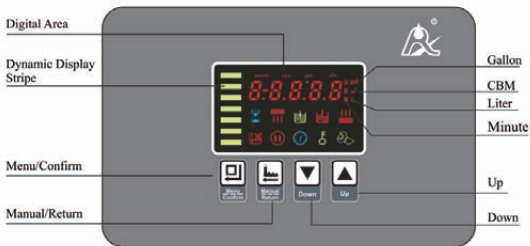



Figure 1-5

2. Basic Setting & Usage



2.1. The Function of PC Board



A.  Time of day indicator







-  lights on, display the time of day.

B.  Button lock indicator





-  lights on, indicates the buttons are locked. At this moment, it is useless to press any single button. (In any status, no operation in one minute,  will light on and lock the buttons.)

- Solution: Press and hold both  and  for 5 seconds until  the lights off.







C.  Program mode indicator

-  lights on, enter program display mode. Press  or  to view all values.
-  flashes, enter program set mode. Press  or  to adjust values.







D.  Menu/Confirm button

- Press ,  lights on, enter program display mode and view all values.
- In program display mode, press ,  flashes, enter program set mode and adjust values.
- Press  after all program are set, and then the voice “Di” means all setting are success and return program display mode.

E.  Manual/Return button







- Press  in any status, it can proceed to next step. (Example: when the outlet water is unqualified, unlock the buttons, press  in Service status, it will start regeneration cycles instantly; Press  while it is in Backwash status, it will end backwash and go to Brine & slow rinse at once.)
- Press  in program display mode, and it will return in Service; Press  in program set mode, and it will return program display mode.
- Press  while adjusting the value, then it will return program display mode directly without saving value.

F. Down  and Up 

- In program display mode, press  or  to view all values.
- In program set mode, press  or  to adjust values.
- Press and hold both  and  for 5 seconds to unlock the buttons.

2.2.Basic Setting & Usage

A.Parameter specification

Function	Indicator	Factory Default	Parameter Set Range	Instruction
Time of Day		Random	00:00~23:59	Set the time of day when use; ":" flashes.
Control Mode	A-01	A-01	A-01	Meter Delayed:Regenerate on the day although the available volume of treated water drops to zero (0). Regeneration starts at the regeneration time.
			A-02	Meter Immediate: Regenerate immediately when the available volume of treated water drops to zero (0).
			A-03	Intelligent Meter Delayed: Meter Delayed Regeneration type, but by setting Resin Volume, Feed Water Hardness, Regeneration Factor, the controller will calculate the System Capacity. Regeneration mode same as A-01.
			A-04	Intelligent Meter Immediate: Meter Immediately Regeneration Type, but by setting Resin Volume, Feed Water Hardness, Regeneration Factor, the controller will calculate the System Capacity. Regeneration mode same as A-02.
Service Day		1-03D	0~99 days	Only for Time Clock Type, regeneration by days.
Regeneration Time	02:00	02:00	00:00~23:59	Regeneration time; ":" lights on
Resin Volume	100	100	20~500	Resin volume in resin tank (L)
Feed Water Hardness	Yd1.2	1.2	0.1-9.9	Feed water hardness (mmol/L)
Exchange Factor	AL.65	0.65	0.3~0.99	Relate to the raw water hardness. When hardness is higher, the factor is smaller.
Water Treatment Capacity		80.00	0~999.99	Water treatment capacity in one circle (m ³)
Rinsing Frequency	F-00	00	00~20	Only for 53508/53608
Backwash Time		10	0~99	Backwash time (Minute)
Brine & slow rinse Time		60	0~99	Brine& slow rinse time (Minute)
Fast Rinse Time		10	0~99	Fast rinse time (Minute)

Brine Refill Time		05	0~99	Brine refill time (Minute)
Maximum Interval Regeneration Days	H-30	30	0~40	Regenerate on the day even though the available volume of treated water does not drop to zero (0).
Output Control Mode	b-01	01	01 or 02	b-01: Signal turn on when start of regeneration and shut off at the end of regeneration. (Connection refers to the Figures on page 6) b-02: Signal available only in intervals of each status. (Connection refers to the Figures on page 6)
Valve Address	1	1	1~247	Valve's number when communicating with an upper computer such as PLC.

B.Process Display (Take 63608 A-01 as an example)



Figure A



Figure B



Figure C



Figure D



Figure E



Figure F

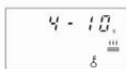

Figure G

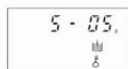

Figure H



Figure I

Illustration:













- In Service status, the figure shows A/B/C/D; In Backwash status, it shows figure E/I; In Brine& slow rinse status, it shows F/I; In Fast Rinse status, it shows figure G/I; In Brine Refill status, it shows figure H/I. In each status, every figure shows 15 seconds.
- For Meter Type, figure A is remaining water capacity. For the Time Clock Type, it shows the rest days, such as 1-03D.
- The display screen will only show “-00-” when the electrical motor is running.
- The time of day figure “⌚” flashes continuously, such as “12:12” flashes, indicates long outage of power. It reminds to reset the time of day.

- The display will show the error code, such as “-E1-” when the system is in error.
- Working process: Service→ Backwash→ Brine & Slow Rinse →Fast Rinse →Brine Refill →Service (Filter valve has no Brine & Slow Rinse and Brine Refill status)













C. Usage (Take 63608 as an example)

After being accomplished installation, parameter setting and trail running, the valve could be put into use. In order to ensure the quality of outlet water can reach the requirement, the user should complete the below works:

- ①Ensure that there is solid salt all the time in the brine tank in the course of using when this valve is used for softening. The brine tank should be added the crystalline coarse salt only, at least 99.5% pure, forbidding use the small salt and iodized salt.
- ②Test the outlet water and raw water hardness at regular time. When the outlet water hardness is unqualified, please press the  after unlock the buttons and the valve will temporarily regenerate again (It will not affect the original set operation cycle.)
- ③When the raw water hardness changes a lot, you can adjust the water treatment capacity as follow:

Press and hold both  and  for 5 seconds to unlock the buttons. Press , and the  lights on, then press , the digital area shows the control mode. If it shows A-01 or A-02, press , and the digital area will show the given water treatment capacity (if the control mode shows A-03 or A-04, then press , the digital area will show the raw water hardness); Press  again,  and digital flashes, press  or  continuously to reset the capacity value (or water hardness). Press  and hear a sound “Di”, then finish the adjustment. Press  exit and turn back the service status.

The estimation of water treatment capacity, you can refer to the professional application specification. When select A-03 or A-04 intelligent control mode, the control will automatically calculate the water treatment capacity by setting resin volume, feed water hardness and regeneration factor.

- ④For A-01 or A-03 control mode (Delayed regeneration type), please pay attention to whether it is current time or not. If the time is not right, you can adjust as follow: After unlock the buttons, press , the  and  light on. Then press , the  and hour value flash. Press  or  continuously to reset the hour value; Press  again,  and minute value flash. Press  or  continuously to reset the minute value; Press  and hear a sound “Di”, then finish the adjustment. Press  exit and turn back the service status.

The regeneration parameters have been set when control valve left factory. Generally, it does not need to reset. If you want enquiry and modify the setting, you can refer to the professional application specification.

3. Applications

3.1. Softener Flow Chart

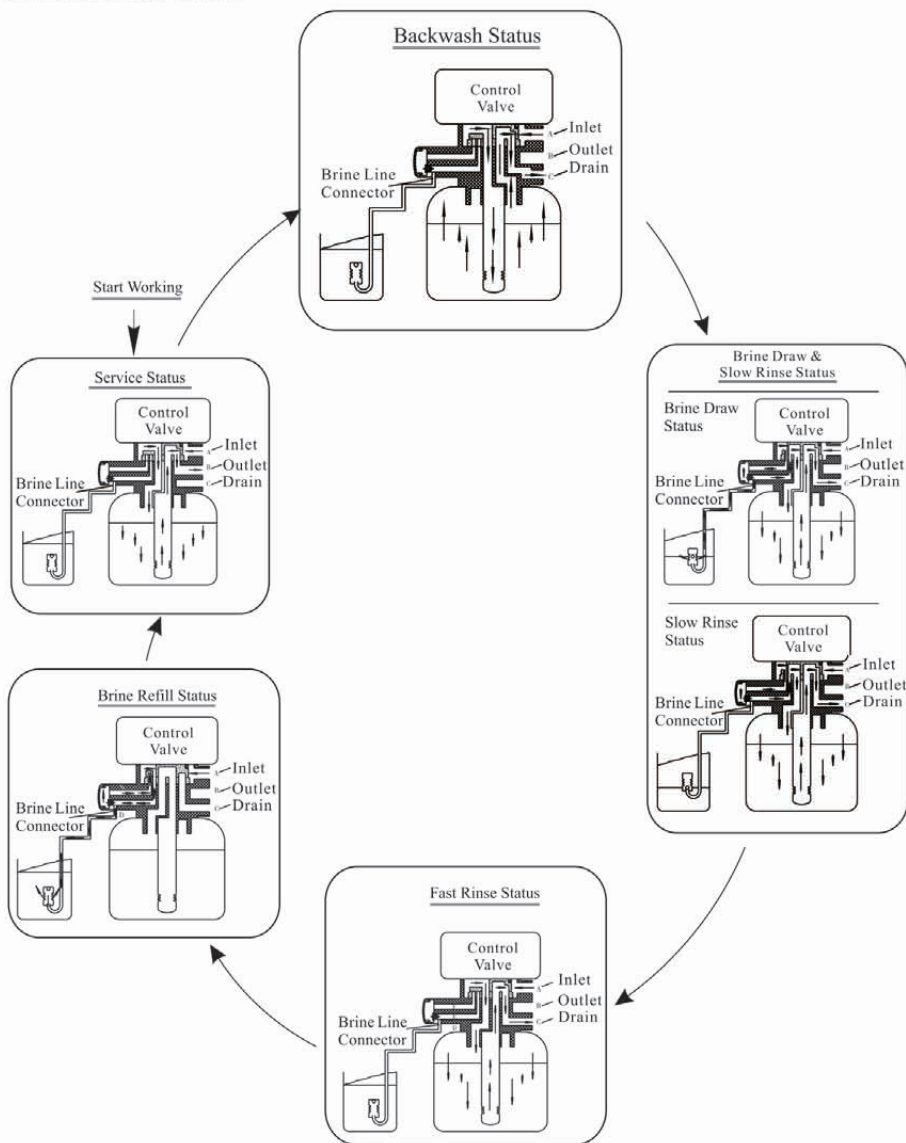

Remark: For filter valve 53508/53608, only have Service, Backwash and Fast Rinse Status.

3.2. The Function and Connection of PC Board

Open the front cover of control valve, you will see the main control board and connection port as below:

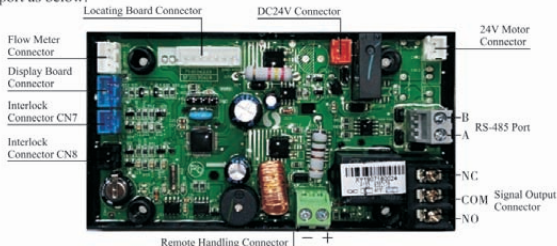

The main functions on main control board:

Function	Application	Explanation
Signal output connector b-01	Outlet solenoid valve	Used in strict requirements regarding no hard water flowing from outlet or controlling the liquid level in water tank.
	Inlet pump	Increase pressure for regeneration or washing. Use the liquid level controller to control inlet pump to ensure there is water in tank.
Signal output connector b-02	Inlet solenoid valve or inlet pump	When inlet pressure is high, it needs to protect motor when valve is rotating.
	Control the inlet bypass to release pressure	When valve is rotating, the connector opened to prevent pressure increasing rapidly.
Interlock connector	To ensure only one control valve regenerate or wash in system.	Use in RO Pre-treatment, water supply together but regeneration in turn. Second grade ion exchange equipment, etc.
Remote handling connector	Receive signal to make the control valve rotate to next status.	It is used for on-line inspection system, connected with PC to realize automatically or remote controlling valve.
RS-485 port	Collect on site data of valve and make the control valverotate to next status.	It is used for connect with PLC to realize collect on site data and remotely control valve.

A. Signal Output Connector

1) Control Outlet Solenoid Valve (Set b-01)

Instruction: Solenoid valve on outlet controls water level in brine tank. If system strictly requires no hard water flowing from outlet in regeneration cycle (Mainly for no hard water flows out when valve is switching or valve in backwash or brine drawing positions), a solenoid valve could be installed on outlet, the wiring refer to Figure 3-1 :

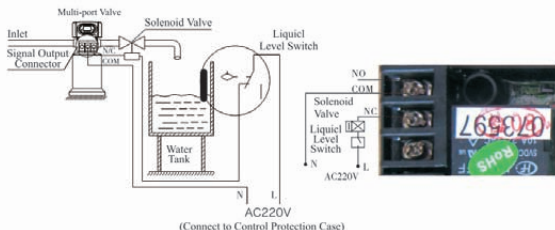

Figure 3-1 Wiring of Solenoid Valve on Outlet

Function:

When valve is in service status, if soft water tank is short of water, solenoid valve will open to supply soft water, but if water tank has enough water, solenoid valve will close, so no soft water is supplied to the tank.

When the valve is in backwash status or other regeneration status, there is no signal output. So, solenoid valve is closed, and no raw water flows into soft water tank.

2) Control Inlet Solenoid Valve (Set b-02)

Instruction: When inlet pressure exceeds 0.6MPa, install a solenoid valve on inlet. Control mode is b-02. Pressure is relieved when valve switching, the wiring refers to Figure 3-2.

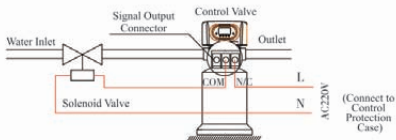

Figure 3-2 Wiring of Solenoid Valve on Inlet

Function:

When inlet pressure is high, install a solenoid valve on inlet to ensure valve switches properly. The solenoid valve will open when valve is exactly at position of Service, Backwash, Brine & Slow Rinse, Brine Refill and Fast Rinse. When valve is switching, solenoid valve is closed, no water flows into valve to ensure valve switching properly. It could prevent the problem of mixing water and water hammer.

Use interlock cable to realize valves in parallel and series in same system which is suited for RO pretreatment system or second grade Na⁺ system. The wiring refers to Figure 3-3:

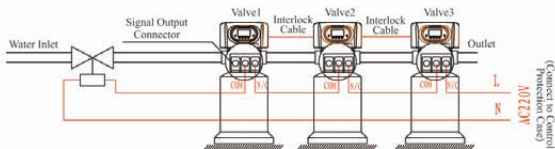

Figure 3-3 Wiring of Solenoid Valve in Inlet

3) Liquid Level Controller Controls Inlet Pump (Two-phase motor) (Set b-01)

Instruction: For the system using underground water or middle-tank supplying water, users can turn on and turn off the pump by operating the switch of liquid level controller and control valve. The wiring refers to Figure 3-4:

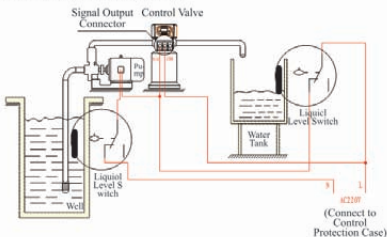

Figure 3-4 Wiring of Liquid Level Controller Controlling Inlet Pump

Function:

When valve is in service status, if water tank is short of water, pump starts working, but if water tank has enough water, the switch of liquid level controller is closed, so pump doesn't work.

When valve in regeneration cycle, inlet always has water no matter what is water condition in water tank. As Runxin valve no water passes outlet in regeneration cycle, it ensure no water fill into brine tank. A liquid switch at the top opening of well or in middle water tank in RO system protects pump from working without water in case of out of raw water.

4) Liquid Level Switch in Water Tank Controls 380V Three-phase Inlet Pump, Figure 3-5 (Set b-01)

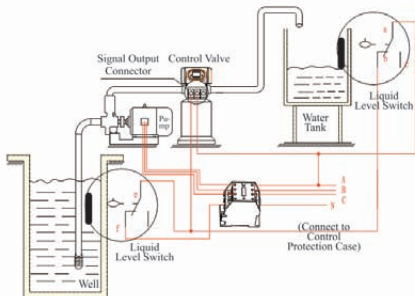

Figure 3-5 Wiring of Liquid Level controller controlling Inlet Pump

5) Control Inlet Booster Pump (Set b-01 or b-02)

Instruction: If inlet water pressure is less than 0.15MPa, which makes backwash or brine drawing difficult, a booster pump is suggested to be installed on inlet. Set Control mode as b-01. When system in regeneration cycle, booster pump opens, the wiring refers to Figure 3-6. If the booster pump current is bigger than 5A, system need to install a contactor, the wiring refers to Figure 3-7.

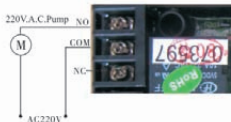

Figure 3-6 Wiring of Booster pump on Inlet

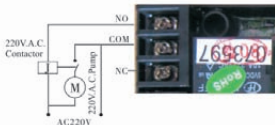

Figure 3-7 Wiring of Booster pump on Inlet

B. Interlock

Instruction: In the parallel water treatment system, it ensures only one valve in regeneration or washing cycle and (n-1) valves in service, that is, realizing the function of supplying water simultaneously and regenerating individually.

In the series and parallel water treatment system (Second grade Na⁺ Exchanger or RO pre-treatment system), it ensures only one valve in regeneration or washing cycle and every grade has water when in regeneration or washing. The wiring refers to Figure 3-8.

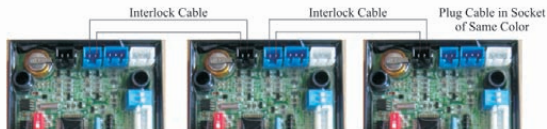

Figure 3-8 Network System Wiring with Interlock Cable

Use Interlock Cable to connect CN8 to CN7 on next valve in the loop. One system with several valves, if interlock cable is disconnected, the system is divided into two individual system.

C. Remote Handling Connector

When the valve is used to make pure water or other system that can be monitored online or connected to a PC, etc., when the conductivity or other parameters reach the set value or the PC sends a signal and needs system regeneration, it can be provide a signal to remote handling connector of main control board by the signal line, which can make the valve regenerate immediately. The connector receiving the signal is equivalent to pressing the manual button. The wiring refers to Figure 3-9.



Figure 3-9 Wiring of Remote Input

D. Interlock System

2 or more than 2 valves are interlocked connecting in one system and all valves are in service but regenerate individually. The wiring refers to Figure 3-10.

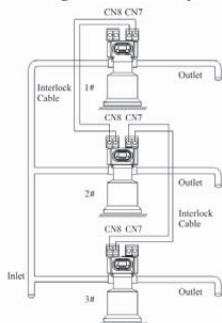

Figure 3-10 Interlock system

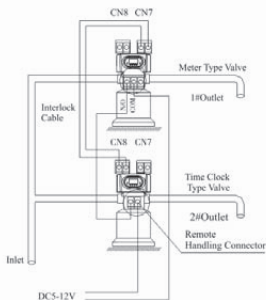

Figure 3-11 Series system

E. Series System

This is a 2 or more than 2 valves system, all in service, with one flow meter for the entire system. For the time type valve, the regeneration time should be set and adjusted to the Max; for the meter type valve, connect its signal output connector with the remote handle connector of the time clock type valve. That can realize the function of supplying water simultaneously and regenerating orderly. The wiring refers to Figure 3-11.

F. RS-485 Communication between PLC and Single Valve

RS-485 communication between PLC and single valve. The wiring refers to Figure 3-12.

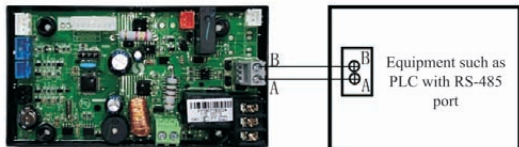

Figure3-12

Instruction:

- 1) Control valve's RS-485 port A and B are respectively connected to PLC's RS-485 port A and B.
- 2) Use twisted pair cables for connection.
- 3) In case of far communication distance, a $120\Omega/4W$ resistor should be connected in parallel to A and B terminals of PLC and valve.
- 4) Keep away from the high voltage cable when wiring the RS-485 communication cable, and do not bundle the high voltage power cable with RS-485 communication cable together.
- 5) As control valve is matched in system, its address range is 1-247 and the default address is 1. Reading or writing data of control valve from PLC should correspond to the number of valve.

G. RS-485 Communication among PLC and Multi-Valves

RS-485 communication among PLC and multi-valves. The wiring refers to Figure 3-13.

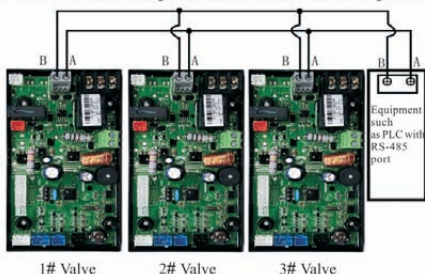

Figure 3-13

Instruction:

- 1) RS-485 port A and B of PLC are respectively connected to RS-485 port A and B of 1# valve. It is as the main wire. Port A and B of 2# and 3# valves are directly connected to A and B main wire in parallel.
- 2) In case of far communication distance, a $120\Omega/4W$ resistor should be connected in parallel to RS-485 port A and B of PLC as well as port A and B of 1# valve. There is no required to connect resistor for port A and B of 2# and 3# valves.
- 3) RS-485 main communication wire can be connected with 32 sets of RS-485 valves or equipments at most. If connecting more RS-485 valves, a 485 repeater should be connected to the main communication wire.
- 4) As control valve is matched in system, its address range is 1-247 and the default address is 1. Reading or writing data of control valve from PLC should correspond to the number of valve.

3.3. RS-485 Port

A. RS-485 communication protocol

- 1) 485 communication protocol: It adopts international MODBUS RTU.
- 2) Information transmission: Half-duplex mode, in bytes.
- 3) Transmission speed: fixed 9600bps baud rate.
- 4) Byte format: 1 start bit, 8 data bits, 1 stop bit, no parity bit. The start bit is 0 and the stop bit is 1.

B. Read control valve on site data

The equipment such as PLC is the master, the valve is the slave, the data of slave valve can be read from PLC.

The valve MODBUS communication address and corresponding data are defined as follows:

MODBU Address	Instruction	Unit	Data Definition	Comment
0x2002	Remaining Water	Integer	0~999	Read remaining water 0~999.99 m ³
0x2003	Remaining Water	Decimal	0~99	
0x2004	Remaining Time	Day/Minute	0~99	Read remaining day/minute
0x2005	Fault Status	/	0x0000: Normal 0x0001:E1 0x0002:E2 0x0003:E3 0x0004:E4	Read valve status
0x2006	Current Flow Rate	0.01m ³ /h	0~500	Read current flow rate
0x2009	Regeneration Time	Hour	0~23	Read regeneration time; set hour value
0x200A	Regeneration Time	Minute	0~59	Read regeneration time; set minute value
0x201D	Current Time	Hour	0~23	Read the hour value of current time
0x201E	Current Time	Minute	0~59	Read the minute value of current time

0x2007	Current Status	/	0x0001:Service 0x0003:Backwash 0x0004:Brine & Slow Rinse 0x0007:Fast Rinse 0x0008:Brine Refill 0x0010:Switch	Read the current status of valve
0x200E	Signal Output	/	0x0001:b-01 0x0002:b-02	Read the set signal output

C. Write Data for Valve:

The equipment such as PLC is the master, the valve is the slave, PLC can write the data of slave valve.

MODBU Address	Instruction	Unit	Data Definition	Comment
0x3002	Regeneration control mode	/	0x0001: A-01 0x0002: A-02 0x0003: A-03 0x0004: A-04	Set the regeneration control mode of meter type valve
0x3018	Switch working position	/	0~1 Variation	Force to regenerate

3.4. System Configuration and Flow Rate Curve

A. Product Configuration

①Softener valve 63508/63608 configuration with tank, resin volume, brine tank and injector.

Tank Size (mm)	Resin Volume (L)	Flow Rate (t/h)	Brine Tank Size (mm)	The Minimum Salt Consumption for Regeneration (Kg)	Injector Model
Φ600×1800	300	7.0	Φ740×1275	45.00	Pink
Φ750×1800	450	11.0	Φ840×1335	67.50	Yellow

Attention: The flow rate calculation is based on linear velocity 25 m/hr; the minimum salt consumption for regeneration calculation is based on salt consumption 150 g/L (Resin).

② Filter valve 53608/53508 configuration with tank, resin volume, brine tank and injector.

Tank Size	Volume of Filter Material	Carbon Filter		Sand Filter	
		Filtering Flow Rate	Backwash Flow Rate	Filtering Flow Rate	Backwash Flow Rate
mm	L	m ³ /h	m ³ /h	m ³ /h	m ³ /h
Φ400×1670	120	1.5	4.5	3.1	6.8
Φ450×1670	150	2	5.9	4.1	8.8
Φ500×1800	200	2.4	7	4.9	10.6
Φ600×1800	300	3.4	10	7	15.2

Attention: The filtering flow rate of carbon filter is calculated based on the 12m/h operation rate; the backwash flow rate is calculated based on the 10L/(m²*s) backwash intensity; the filtering flow rate of sand filter is calculated based on the 25m/h operation rate; the backwash flow rate is calculated based on the 15L/(m²*s) backwash intensity.

B. Flow Rate Characteristic

1) Pressure--flow rate curve

Softener Valve: 63508/63608

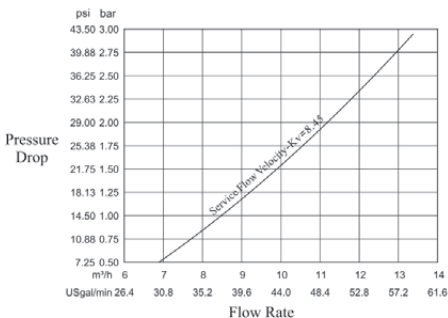

Filter Valve: 53508/53608

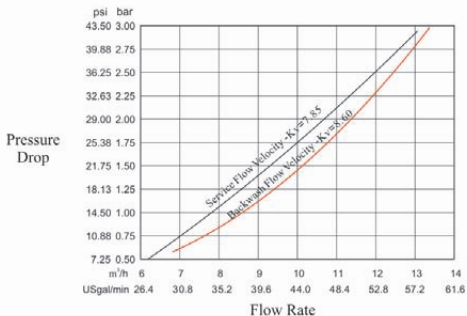

2) Configuration for standard injector and drain line flow control

Inlet Pressure	Total Flow Rate on Injector (L/M)		Flow Rate of Drain Line Flow Control (L/M)			
	Pink	Yellow	1#	2#	3#	4#
0.15	15.7	17.7	48.2	55	54.9	64
0.20	18.55	20.9	55.6	63.1	62.5	70.6
0.25	20.85	23.5	61.5	71.2	71.1	78.2
0.30	22.45	26.3	68.5	77	77.3	84
0.35	24.15	28.05	71.9	79.1	84.2	92
0.40	25.9	30.1	76.8	88.6	91.4	98.4

3) Configuration for Standard Injector and Drain Line Flow Control

Tank Dia. mm	Injector	Total Flow Rate on Injector	Flow Rate of Slow Rinse	Flow Rate of Brine Refill	DLFC	Flow Rate of Backwash and Fast Rinse
		L/m	L/m	L/m		L/m
600	Pink	22.45	15.8	32.9	3#	77.3
750	Yellow	25.1	17.8	50.5	4#	84

Remark:

● Above data for the product configuration and relevant characteristics are only for reference. When put in practice, please subject to the different requirements of raw water hardness and application.

● The above data in table is tested under pressure of 0.3 MPa.

3.5. Parameter settlement

① Service time T1

Water treatment capacity:

$$Q = V_r \times K \div Y_D (\text{m}^3)$$

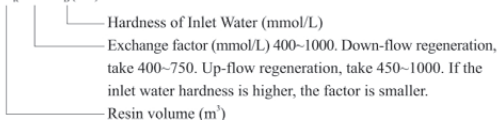

By days: $T1 = Q \div Q_d$ (Day)

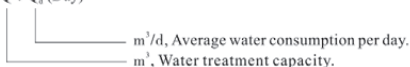

② Backwash time T2

Generally, It is suggested to set 10~15 minutes. The higher the turbidity is, the longer backwash time can be set. However, if the turbidity is more than 5 FTU, it should be better to install a filter in front of the exchanger.

③ Brine & Slow rinse time T3

$$T3 = (40 \sim 50) \times H_r (\text{min})$$

Generally, $T3 = 45H_r$ (min)

In this formula, H_r — the height of resin in exchange tank (m.)

④ Brine refill time T4

Down-flow regeneration: $T4=0.45 \times V_r \div \text{Brine refill speed (min.)}$

Up-flow regeneration: $T4=0.34 \times V_r \div \text{Brine refill speed (min.)}$

In this formula, V_r —Resin volume, m^3 ;

The Brine refill speed is related to inlet water pressure. It is suggested to lengthen 1~2 minutes of calculated brine refilling time to make sure there is enough water in tank. (The condition is that there is a level controller installed in the brine tank)

⑤ Fast rinse time T5

$T5=12 \times H_r$ (min)

Generally, the water for fast rinse is 3~6 times of resin volume. It is suggested to be set 10~16 minutes, but it should be washed until the outlet water meets the requirements.

⑥ Exchange factor

Exchange factor= $E/(k \times 1000)$

In this formula, E —Resin working exchange capability (mol/m^3) it is related to the quality of resin. Down-flow regeneration, take 800~900. Up-flow regeneration, take 900~1200.









K —Security factor, always take 1.2~2. It is related to the hardness of inlet water: the higher the hardness is, the bigger the K is.

⑦ Regeneration time: The whole cycle for regeneration is about two hours. Please try to set up the regeneration time when you don't need to use water according to the actual situation.

The calculation of parameters for each step is only for reference, the actual proper time will be determined after adjusting by water exchanger supplier. This calculation procedure of softener is only for industrial application; it is not suitable for small softener in residential application.

3.6. Parameter Enquiry and Setting (Take 63608 as example)

3.6.1 Parameter Enquiry (take 63608 A-01 as example)

When  lights on, press and hold both  and  for 5 seconds to unlock buttons; then press  and  lights on, enter to program display mode; press  or  to view each value according to below process. (Press  exit and turn back to service status.)

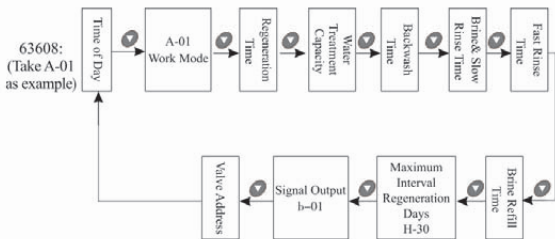





















































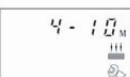















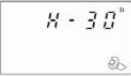



3.6.2 Parameter Setting (Take 63608 A-01 as example)

In program display mode, press and enter into program set mode. Press or to adjust the value.













3.6.3 The Steps of Parameter Setting

Items	Process steps	Symbol
Time of Day	<p>When time of day "12:12" continuously flashes, it reminds to reset;</p> <ol style="list-style-type: none"> 1. Press to enter into program display mode; both and symbol light on, ":" flashes; Press enter program set mode, both and hour value flash, through or to adjust the hour value; 2. Press again, both and minute value flash, through or to adjust the minute value; 3. Press , then finish adjustment, press to turn back. 	
Control Mode	<ol style="list-style-type: none"> 1. In control mode display status, press and enter into program set mode, and 01 value flash; 2. Press or , set the value to be A-01, A-02, A-03 or A-04 control mode; 3. Press then finish adjustment, press to turn back. 	

Regeneration Time	<ol style="list-style-type: none"> 1. In regeneration time display status, press  to enter program set mode, it shows 02:00,  and 02 flash. 2. Press  or  to adjust the hour value; 3. Press ,  and 00 flash, press  or  to adjust the minute value; 4. Press  then finish adjustment, press  to turn back. 	
Water Treatment Capacity	<ol style="list-style-type: none"> 1. In water treatment capacity display status, it shows  and 80.00. Press  and enter into program set mode.  and 80 flash; 2. Press  or  to adjust the water treatment capacity value (m³); 3. Press , decimal value flash. Press  or  to adjust the decimal value; 4. Press  then finish adjustment, press  to turn back. 	
Backwash Time	<ol style="list-style-type: none"> 1. In backwash time display status, it shows  and 2-10. Press  and enter into program set mode.  and 10 flash; 2. Press  or  to adjust the backwash minute value; 3. Press  then finish adjustment, press  to turn back. 	
Brine & Slow Rinse Time	<ol style="list-style-type: none"> 1. In brine & slow rinse time display status, it shows  and 3-60. Press  and enter into program set mode.  and 60 flash; 2. Press  or  to adjust the brine & slow rinse time minute value; 3. Press  then finish adjustment, press  to turn back. 	
Fast Rinse Time	<ol style="list-style-type: none"> 1. In fast rinse time display status, it shows  and 4-10. Press  and enter into program set mode.  and 10 flash; 2. Press  or  to adjust the fast rinse time minute value; 3. Press  then finish adjustment, press  to turn back. 	

<p>Brine Refill Time</p>	<p>1. In brine refill time display status, it shows  and 5-05, Press  and enter into program set mode.  and 05 flash; 2. Press  or  to modify the brine refill minute value; 3. Press  then finish adjustment, press  to turn back.</p>	
<p>Maximum Interval Regeneration Days</p>	<p>1. In maximum Interval regeneration days display status, it shows H-30. Press  and enter into program set mode.  and 30 flash; 2. Press  or  to adjust the Interval regeneration days; 3. Press  then finish adjustment, press  to turn back.</p>	
<p>Signal Output Mode</p>	<p>1. In signal output mode display status, it shows b-01. Press  and enter into program set mode.  and 01 flash; 2. Press  or  to adjust the signal output mode; 3. Press  then finish adjustment, press  to turn back.</p>	
<p>Valve Address (Valve's number in system)</p>	<p>1. In the valve address enquiry status, it shows 1. Press  and enter into program set mode.  and 1 flash; 2. Press  or  to adjust valve address; 3. Press  then finish adjustment, press  to turn back.</p>	

For example, the fast rinse time of a softener is 10 minutes. After regenerating, the chloridion in the outlet water is always higher than normal, indicating that there is not enough time for fast rinse. If you want the time to set to 15 minutes, the modification steps as follows:

- ① Press and hold both  and  to unlock the buttons. ( lights off);
- ② Press , and  lights on;
- ③ Press  or  continuously until  lights on. Then the digital area shows: 4-10:00;
- ④ Press ,  and 10 flash;
- ⑤ Press  continuously until 10 changed to 15;
- ⑥ Press , there is a sound "Di" and the figure stop flashing; the program back to enquiry status;
- ⑦ If you want to adjust other parameters, you can repeat the steps from ② to ⑤; If you don't, press  and quit from the enquiry status, the display will show the current service status.



3.7. Trial running



After installing the multi-functional flow control valve on the resin tank with the connected pipes, as well as setting up the relevant parameter, please conduct the trial running as follows:



A. Close the inlet and outlet valve B & C, and open the bypass valve A. After cleaning the foreign materials in the pipe, close the bypass valve A. (As Figure 1-3 shows).



Softener Valve Adjusting:



B. Add calculated water to the brine tank and adjust the air check valve. Then add solid salt to the tank and dissolve the salt as much as possible.

C. Switch on power. Press  and turn to the Backwash position; when  lights on, slowly open the inlet valve B to 1/4 position, making the water flows into the resin tank; you can hear the sound of air-out from the drain pipeline. After all air is out of pipeline, then open inlet valve B completely and clean the foreign materials in the resin tank until the outlet water is clean. It will take 8~10 minutes to finish the whole process.

D. Press , turning the position from Backwash to Brine & Slow Rinse;  lights on and enter in the process of Brine & Slow Rinse. The air check valve closes when control valve finish brine draw, then slow rinse starts to work. It takes about 60~65 minutes for whole process.

E. Press , turning the position from Slow Rinse to Fast Rinse.  lights on and starts to fast rinse. It takes about 10~15 minutes, take out some outlet water for testing: If the water hardness reach the requirement, and the chloridion in the water is almost the same compared with the inlet water, then go to the next step.

F. Press , turning the position from Fast Rinse to Brine Refill.  lights on, the valve starts brine refill until the brine tank is being refilled with water to the required level. It takes about 5~6 minutes, then add solid salt to the brine tank.

G. Press , making the control valve return to Service Status;  lights on and starts to running.

Note:

● When the control valve enters the regeneration status, all programs can be finished automatically according to the setting time; if you want one of steps to be terminated early, you can press .



● If water inflows too fast, the media in tank will be damaged. When water inflows slowly, there is a sound of air emptying from drain pipeline.



● After changing resin, please empty air in the resin according to the above Step C.



● In the process of trial running, please check the water situation in all positions, and ensure there is no resin leakage.

● The time for Backwash, Brine& Slow Rinse, Fast Rinse and Brine Refill position can be set and executed according to the calculation in the formula or suggested from the control valve suppliers.

Filter Valve Adjusting:

H. Press , and turn to the Backwash position; when  lights on, slowly open the inlet valve B to 1/4 position, making the water flows into the resin tank; you can hear the sound of air-out from the drain pipeline. After all air is out of pipeline, then open inlet valve B completely and clean the foreign materials in the resin tank until the outlet water is clean. It will take 8~10 minutes to finish the whole process.

I. Press , turning the position from Backwash to Fast Rinse.  lights on and starts to fast rinse. It takes about 10~15 minutes.

J. Take out some outlet water for testing, if the water hardness reach the requirement, then press , making the control valve return to Service Status;  lights on and starts to running.

Note:

● When the control valve enters the regeneration status, all programs can be finished automatically according to the setting time; if you want one of steps to be terminated early, you can press .

● After changing filter material, please empty air in the filter material according to the above Step B.

● In the process of trial running, please check the water situation in all positions, and ensure there is no filter material leakage.

● The time for Backwash and Fast Rinse position can be set and executed according to the calculation in the formula or suggested from the control valve suppliers.

3.8. Trouble-Shooting

A. Control Valve Fault

Problem	Cause	Correction
Filter Valve		
1. Filter fails to rinse	A. Electrical service to unit has been interrupted. B. Rinse time is set incorrect. C. Controller is defective.	A. Assure permanent electrical service (Check fuse, plug, pull chain or switch). B. Reset the time. C. Check or replace the controller.
2. Filter supply raw water	A. Bypass valve open. B. Riser pipe leak. C. Internal valve leak.	A. Close the bypass ball valve. B. Make sure riser pipe and O-ring are not cracked. C. Check or change valve body.
3. Water pressure lost	A. Iron is in the water supply pipe. B. Iron mass is in the filter.	A. Clean the water supply pipe. B. Clean valve and add filter materials cleaning chemical, increase frequency of rinsing.
4. Loss of filter materials through drain line	A. Air in the water system. B. The strength of backwash is too high. C. Strainer is broken.	A. Assure that well system is dry and has proper air eliminator control. B. Reduce the strength of backwash. C. Replace the strainer.
5. Control cycle continuously.	A. Locating signal wiring break down. B. Controller is faulty. C. Foreign material stuck the driving gear.	A. Check and connect locating signal wiring. B. Replace controller. C. Take out foreign material.
6. Drain flows continuously.	A. Internal valve leaks. B. Power off when valve is in backwash or fast rinse status.	A. Check and repair valve body or replace it. B. Turn off bypass valve and restart when power on.
Softener Valve		
1. Softener fails to regenerate.	A. Electrical service to unit has been interrupted. B. Regeneration cycles set incorrect. C. Controller is defective. D. Motor fails to work.	A. Assure permanent electrical service (Check fuse, plug, pull chain or switch). B. Reset regeneration cycles. C. Check or replace controller. D. Check or replace motor.
2. Regeneration time is not correct.	A. Time of Day does not set correctly. B. Power failure more than 3 days, the time of day is incorrect.	A. Check program and reset time of day. B. Reset time of day.

<p>3. Softener supply hard water.</p>	<p>A. Bypass valve is open or leaking. B. No salt in brine tank. C. Injector is plugged. D. Insufficient water flows into brine tank. E. Internal valve leak. F. Incorrect regeneration time or raw water quality deterioration. G. Shortage of resin. H. Bad quality of raw water or turbine is blocked.</p>	<p>A. Close or repair bypass valve. B. Add salt to brine tank and maintain salt level above water level. C. Change or clean injector. D. Check Brine refill time. E. Check or change valve body. F. Set correct regeneration time or water capacity treatment. G. Add resin to mineral tank and check whether resin leaks. H. Reduce the inlet turbidity, clean or replace turbine.</p>
<p>4. Softener fails to draw brine.</p>	<p>A. Inlet line pressure is too low. B. Brine line is plugged . C. Brine line is leaking. D. Injector is plugged or broken down. E. Internal control leak. F. Drain line is plugged. G. Sizes of injector and DLFC are not matched with tank. H. Ball valve or cable break down.</p>	<p>A. Increase inlet line pressure. B. Clean brine line. C. Replace brine line. D. Clean or replace new injectors. E. Replace valve body. F. Clean drain line flow control. G. Select correct injector size and DLFC according to the P29 requirements. H. Repair or replace ball valve or cable.</p>
<p>5. Unit used too much salt.</p>	<p>A. Improper salt setting. B. Excessive water in brine tank.</p>	<p>A. Check salt usage and salt setting. B. See problem no.6.</p>
<p>6. Excessive water in brine tank.</p>	<p>A. Overlong refilling time. B. Remain too much water after brine draw. C. Foreign material in brine valve. D. Power outage when brining and system without liquid level controller. E. Brine refill is out of control. F. Ball valve doesn't close.</p>	<p>A. Reset correct brine refilling time. B. Check the injector and make sure no stuff in the brine pipe. C. Clean brine valve and brine line. D. Stop water supplying and restart pr install safety brine valve in salt tank. E. Repair or replace safety brine valve. F. Replace ball valve.</p>

<p>7. Pressure lost or iron in conditioned water.</p>	<p>A. Iron in the water supply pipe. B. Iron mass in the softener. C. Fouled resin bed. D. Too much iron in the raw water.</p>	<p>A. Clean the water supply pipe. B. Clean valve and add resin cleaning chemical, increase frequency of regeneration. C. Check backwash, brine draw and Brine refill. Increase frequency of regeneration and backwash time. D. Iron removal equipment is required to install before softening.</p>
<p>8. Loss of resin through drain line.</p>	<p>A. Air in water system. B. Strainer is broken. C. Backwash flow rate is too high.</p>	<p>A. Exhaust air exist in system. B. Replace new bottom strainer. C. Check for proper drain rate.</p>
<p>9. Control cycle continuously.</p>	<p>A. Locating signal wiring breaks down. B. Controller is faulty. C. Foreign material stuck the driving gear. D. Time of regeneration steps were set to zero.</p>	<p>A. Exhaust air exist in system. B. Replace new bottom strainer. C. Check for proper drain rate. D. Check program setting and reset.</p>
<p>10. Drain flows continuously.</p>	<p>A. Internal valve leaks. B. Power off when valve is in backwash or fast rinse status.</p>	<p>A. Check and repair valve body or replace it. B. Adjust valve to service position or turn off bypass valve and restart when electricity supply.</p>
<p>11. Interrupted or irregular brine.</p>	<p>A. Water pressure is too low or not stable. B. Injector is plugged or faulty. C. Air in resin tank. D. Floccules in resin tank during up-flow regeneration.</p>	<p>A. Increase water pressure. B. Clean or replace injector. C. Check and find the reason of air intake. D. Clean the floccules in resin tank.</p>
<p>12. Water flows out from drain or brine pipe after regeneration.</p>	<p>A. Foreign material in valve which makes valve can't be closed completely. B. Hard water mixed in valve body. C. Water pressure is too high which results in valve could not get the right position. D. Ball valve doesn't close.</p>	<p>A. Clean foreign material in valve body. B. Change valve core or sealing ring. C. Reduce water pressure or use pressure relief function. D. Repair or replace ball valve.</p>

13. Salt water in softener water.	A. Foreign material in injector or injector fails to work. B. Brine valve cannot shut-off. C. Time of fast rinse is too short.	A. Clean and repair injector. B. Repair brine valve and clean it. C. Extend fast rinse time.
14. Unit capacity decreases.	A. Doesn't regenerate properly. B. Fouled resin bed. C. Salt consumption is not proper. D. Softener setting is not proper. E. Raw water quality deterioration. F. Turbine of flow meter is stuck.	A. Regenerate according to the correct operation requirement. B. Increase backwash flow rate and times, clean or change resin. C. Readjust salt consumption. D. According to the test of outlet water, recount and reset. E. Regenerate unit manually, then reset regeneration cycle. F. Disassemble flow meter and clean it or replace a new flow meter.

B. Controller Fault

Problem	Cause	Correction
1. All indicators display on front panel.	A. Wiring of display board with control board fails to work. B. Control board is faulty. C. Transformer is damaged. D. Electrical service is not stable. E. Display board is faulty.	A. Check and replace the wiring. B. Replace control board. C. Check and replace transformer. D. Check and adjust electrical service. E. Replace display board.
2. No display on front panel.	A. Wiring of front panel with control board fails to work. B. Display board is damaged. C. Control board is damaged. D. Transformer is damaged.	A. Check and replace wiring. B. Replace display board. C. Replace control board. D. Check transformer.
3. EI Flashes	A. Wiring of locating board with control board is broken. B. Locating board is damaged. C. Mechanical driven failure. D. Control board is damaged. E. Wiring of motor with control board is fault. F. Motor is damaged.	A. Replace wiring. B. Replace locating board. C. Check and repair mechanical part. D. Replace control board. E. Replace wiring. F. Replace motor.

4. E2 Flashes	<p>A. Wiring of locating board with control board fails to work.</p> <p>B. Locating board is broken.</p> <p>C. Control board is faulty.</p>	<p>A. Replace wiring.</p> <p>B. Replace locating board.</p> <p>C. Replace control board.</p>
5. E3 or E4 Flashes	<p>A. Control board is faulty.</p>	<p>A. Replace control board.</p>
6. RS-485 communication doesn't work	<p>A. Wrong connection of RS-485 port wires.</p> <p>B. Valve address of PLC is incorrect.</p>	<p>A. Reconnect RS-485 port wires.</p> <p>B. Reset the valve address of PLC as the same as that on the valve.</p>

3.8. Assembly & Parts

F134A3 (53608) Structure

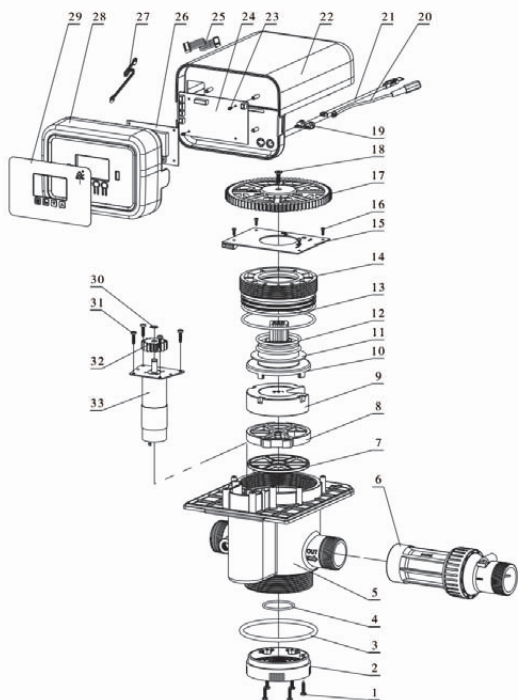

Component and part No. for F134A1/F134A3 (Components for F134A1 without No.6 and No.21)

Item No.	Description	Part No.	Quantity	Item No.	Description	Part No.	Quantity
1	Screw, Cross ST3.9×19	8909003	5	17	Gear	5241014	1
2	Connector	8458018	1	18	Screw, Cross ST4.8 × 19	8909018	1
3	O-ring 104.6 × 5.7	8378146	1	19	Wire Clip	8126004	2
4	O-ring 42.52 × 2.62 (U.S. Riser Pipe)	8378325	1	20	Power Wire	5513001	1
	O-ring 40 × 2.65 (GB Riser Pipe)	8378091		21	Probe Wire	6386002	1
5	Valve Body (U.S. Riser Pipe)	5022172A	1	22	Dust Cover	8005094	1
	Valve Body (GB Riser Pipe)	5022172		23	Screw, Cross ST 2.2 × 6.5	8909004	2
6	Flow Meter	5447010	1	24	Control Board	6382176	1
7	Seal Ring	8370148	1	25	Wire for Locating Board	5511019	1
8	Fixed Disk	8469110	1	26	Display Board	6381003	1
9	Moving Disk	8459105	1	27	Wire for Display Board	5512001	1
10	Shaft	8258051	1	28	Front Cover	8300062	1
11	Anti-friction Washer	8216006	1	29	Sticker (Chinese)	8865181	1
12	O-Ring 59.92 × 3.53	8378110	2		Sticker (English)	8865645	1
13	O-Ring 103 × 3.55	8378130	2	30	Pin	8994026	1
14	Fitting Nut	8092055	1	31	Screw, Cross ST3.9×16	8909044	4
15	Locating Board	6380072	1	32	Small Gear	8241054	1
16	Screw, Cross ST2.9 × 9.5	8909008	4	33	Motor	6158083	1

F133A3 (63608) Structure

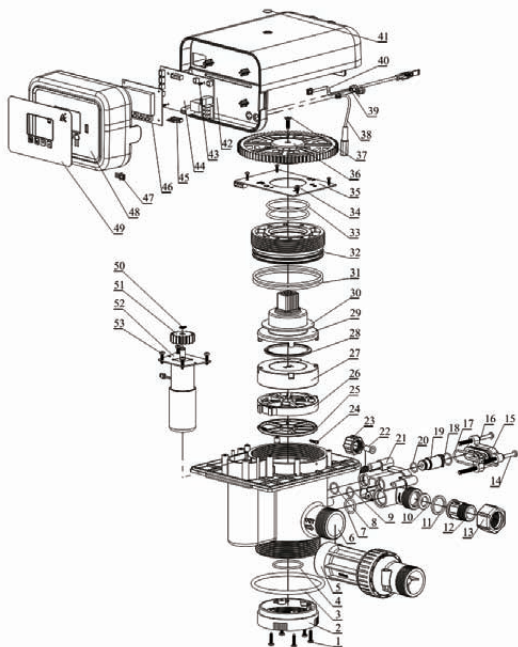

MODEL: F133A1-63508/F133A3-63608/F134A1-53508/F134A3-53608

Component and part No. for F133A1/F133A3 (Components for F133A1 without No.5 and No.40)

Item No.	Description	Part No.	Quantity	Item No.	Description	Part No.	Quantity
1	Screw, Cross ST3.9 x 19	8909003	5	22	Tube	8457025	1
2	Connector	8458018	1	23	Hexagonal Nut	8940016	1
3	O-ring 104.6 x 5.7	8378146	1	24	Screw, Cross ST2.9 x 16	8909010	2
4	O-ring 42.52 x 2.62 (U.S. Riser Pipe)	8378325	1	25	Seal Ring	8370149	1
	O-ring 40 x 2.65 (GB Riser Pipe)	8378091		26	Fixed Disk	8469109	1
5	Flow Meter	5447010	1	27	Moving Disk	8459104	1
6	Valve Body (U.S. Riser Pipe)	5022173A	1	28	Moving Seal Ring	8370023	1
	Valve Body (GB Riser Pipe)	5022173		29	Shaft	8258051	1
7	O-Ring 19 x 2.65	8378074	1	30	Anti-friction Washer	8216006	1
8	O-Ring 15 x 1.8	8378179	1	31	O-ring 103 x 3.55	8378130	2
9	O-Ring 13 x 1.8	8378265	1	32	Fitting Nut	8092055	1
10	Flow Control	8468010	1	33	O-ring 59.92 x 3.53	8378110	2
11	Seal Ring	8371053	1	34	Screw, Cross ST 2.9 x 9.5	8909008	4
12	Connector	8458219	1	35	Locating Board	6380070	1
13	Animated Nut	8945043	1	36	Gear	5241004	1
14	Screw, Cross M5 x 80	8902086	1	37	Screw, Cross ST 4.8 x 19	8909018	1
15	Injector Cover	8315138	1	38	Power Wire	5513001	1
16	Screw, Cross M5 x 70	8902085	2	39	Wire Clip	8126004	2
17	O-Ring 37.77 x 2.62	8378326	1	40	Probe Wire	6386002	1
18	O-Ring 15.8 x 1.8	8378159	1	41	Label	8860024	1
19	Injector	5468207	1	42	Dust Cover	8005094	1
20	O-Ring 12.5 x 1.8	8378244	1	43	Screw, Cross ST2.2 x 6.5	8909004	2
21	Injector Body	8008019	1				

44	Control Board	6382176	1	50	Pin	8994026	1
45	Wire for Locating Board	5511019	1	51	Small Gear	8241054	1
46	Display Board	6381003	1	52	Motor	6158081	1
47	Wire for Display Board	5512001	1	53	Screw, Cross ST3.9 × 16	8909044	4
48	Front Cover	8300062	1				
49	Sticker (Chinese)	8865181	1				
	Sticker (English)	8865645	1				

5447010 Flow Meter Structure:

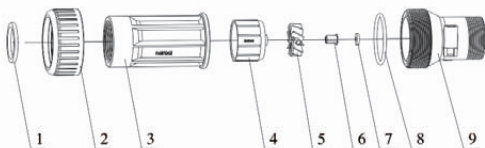

5022004 Flow Meter Connector and Part No.

Item No.	Description	Part No.	Quantity	Item No.	Description	Part No.	Quantity
1	Seal Ring	8371030	1	6	Rotate Core	8211003	1
2	Animated Nut	8947023	1	7	Bush	8210002	1
3	Connector	8458062	1	8	O-Ring 50.39 × 3.53	8378107	1
4	Toggle	8109040	1				
5	Impeller	5436009	1	9	Shell	5002004	1

4. Warranty Card

Dear client:

This warranty card is the guarantee proof of Runxin brand multi-functional flow control valve. It is kept by client self. You could get the after-sales services from the supplier which is appointed by Runxin manufacturer. Please keep it properly. It couldn't be retrieved if lost.

It couldn't be repaired free of charge under the below conditions:

1. Guarantee period expired. (One year)
2. Damage resulting from using, maintenance, and keeping that are not in accordance with the instruction.
3. Damage resulting from repairing not by the appointed maintenance personnel.
4. Content in guarantee proof is unconfirmed with the label on the real good or be altered.
5. Damage resulting from force majeure.

Product Name	 Multi-functional Flow Control Valve for Water Treatment Systems			
Model		Code of Valve Body		
Purchase Company Name		Tel/Cel.		
Problem				
Solution				
Date of Repairing		Date of Accomplishment		Maintenance Man Signature

When product needs warranty service, please fill in the below content and send this card together with the product to the appointed suppliers or Runxin company.

End-user Company Name		Tel/Cel.		
Purchase Company Name		Tel/Cel.		
Model		Code of Valve Body		
Tank Size ϕ ×		Resin Tank Size L	Raw Water Hardness	Mmol/L
Water Source: Ground-water <input type="checkbox"/> Tap Water <input type="checkbox"/>		Water Treatment Capacity m ³	Backwash Time	min
Brine & Slow Rinse Time min		Brine Refill Time min	Fast Rinse Time	min
Problem Description				



WENZHOU RUNXIN MANUFACTURING MACHINE CO.,LTD

ADD: NO.169, RUNXIN ROAD, SHANFU TOWN, WENZHOU, ZHEJIANG, CHINA.

TEL.:0086-577-88630038, 88576512, 85956057 FAX:0086-577-88633258

E-MAIL: sales@run-xin.com <http://www.run-xin.com>